

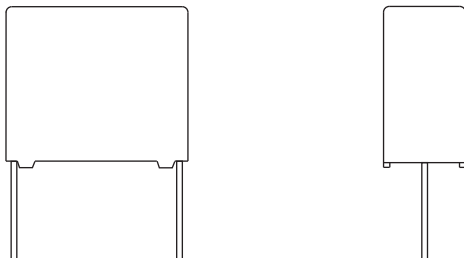

AC and Pulse Metallized Polypropylene Film Capacitors MKP/MKP Radial Potted Type



FEATURES

- 15 mm to 27.5 mm pitch
- Material categorization:
for definitions of compliance please see www.vishay.com/doc?99912

APPLICATIONS

- Where steep pulses occur e.g. SMPS (switch mode power supplies)
- Motor control circuits



RoHS
COMPLIANT
HALOGEN
FREE
GREEN
(5-2008)

QUICK REFERENCE DATA	
Capacitance range (E24 series)	0.002 μ F to 0.68 μ F
Capacitance tolerance	\pm 5 %
Climatic testing class according to IEC 60068-1	55/085/56
Rated DC temperature	85 °C
Rated AC temperature	70 °C
Maximum application temperature	85 °C
Reference specifications	IEC 60384-17
Dielectric	Polypropylene film
Electrodes	Metallized film
Construction	Internal serial construction
Encapsulation	Flame retardant plastic case and epoxy resin (UL-class 94 V-0)
Leads	Tinned wire
Marking	C-value; tolerance; rated voltage; manufacturer's type designation; code for dielectric material; manufacturer's emblem; code for factory of origin; year and week of manufacture
Rated DC voltage	630 V _{DC} ; 1000 V _{DC} ; 1600 V _{DC} ; 2000 V _{DC}
Rated AC voltage	300 V _{AC} ; 400 V _{AC} ; 500 V _{AC} ; 600 V _{AC}
Rated peak-to-peak voltage	850 V; 1130 V; 1400 V; 1700 V
Performance grade	Grade 1 (long life)
Stability grade	Pitch 15 mm: grade 2 Pitch 22.5 mm and 27.5 mm: grade 1

Note

- For more detailed data and test requirements contact: dc-film@vishay.com

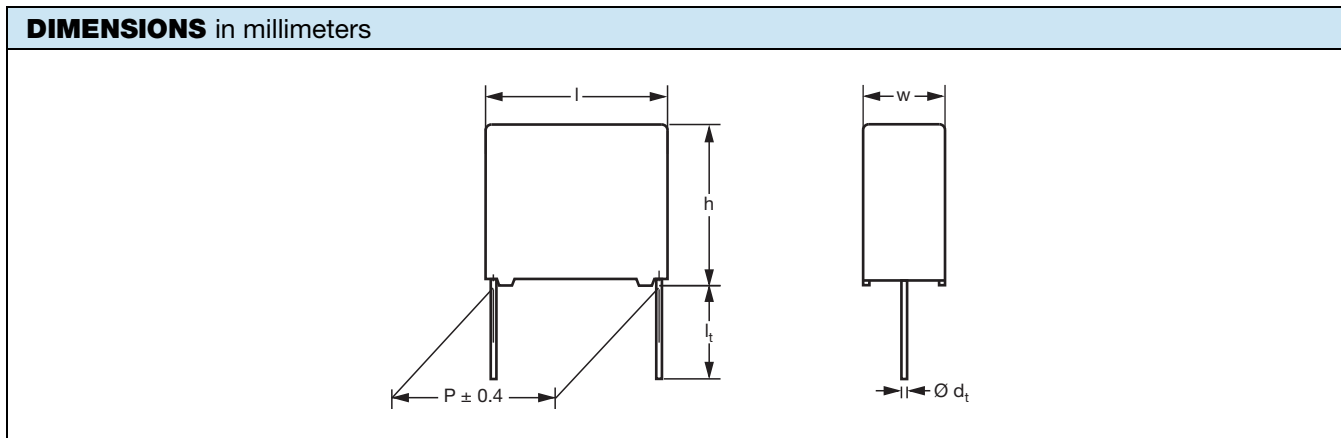

COMPOSITION OF CATALOG NUMBER

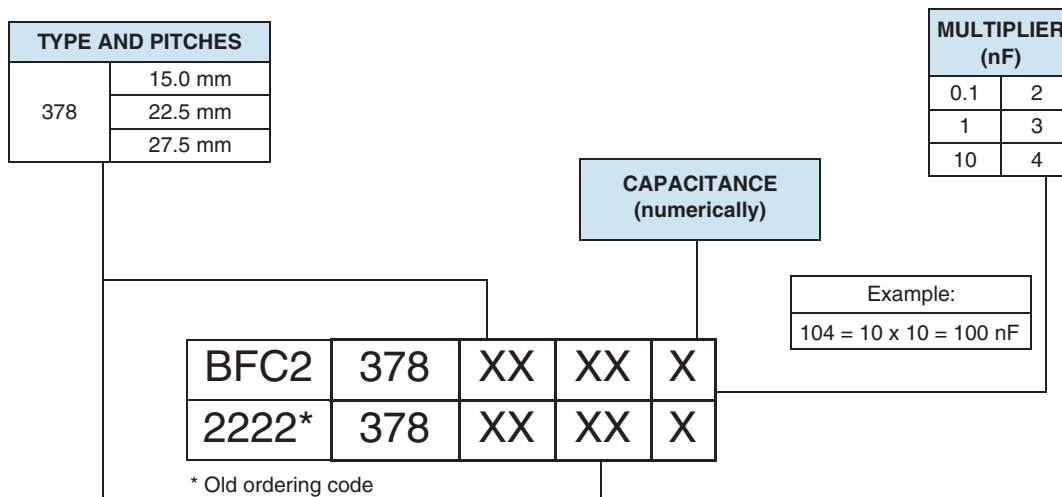

TYPE	PACKAGING	LEAD CONFIGURATION	PREFERRED TYPES				
			C-TOL.	630 V	1000 V	1600 V	2000 V
380	Loose in box	Lead length 3.5 mm ± 0.3 mm	± 5 %	64	74	84	94
TYPE	PACKAGING	LEAD CONFIGURATION	ON REQUEST				
378	Loose in box	Lead length 5.0 mm ± 1.0 mm	± 5 %	62	72	82	92
	Taped on reel	H = 18.5 mm; P ₀ = 12.7 mm		65	75	85	95



SPECIFIC REFERENCE DATA - 630 V _{DC}		
DESCRIPTION	VALUE	
Tangent of loss angle: C ≤ 0.18 μF 0.2 μF ≤ C ≤ 0.3 μF 0.33 μF ≤ C ≤ 0.39 μF 0.43 μF ≤ C ≤ 0.51 μF C > 0.51 μF	at 10 kHz	at 100 kHz
	≤ 10 x 10 ⁻⁴	≤ 35 x 10 ⁻⁴
	≤ 10 x 10 ⁻⁴	≤ 45 x 10 ⁻⁴
	≤ 10 x 10 ⁻⁴	≤ 55 x 10 ⁻⁴
	≤ 10 x 10 ⁻⁴	≤ 65 x 10 ⁻⁴
Rated voltage pulse slope (dU/dt) _R : P = 15 mm P = 22.5 mm P = 27.5 mm P = 27.5 mm	500 V/μs 370 V/μs 230 V/μs (b < 15 mm) 120 V/μs (b ≥ 15 mm)	
	R between leads, for C ≤ 1 μF; 500 V; 1 min	
	> 100 000 MΩ	
	R between leads and case; 500 V; 1 min	
> 100 000 MΩ		
Ionization (AC) voltage (typical value) at 50 pC peak discharge		> 400 V
Withstanding (DC) voltage (cut off current 10 mA) ⁽¹⁾ ; rise time ≤ 1000 V/s		1008 V; 1 min
Withstanding (DC) voltage between leads and case		2840 V; 1 min

Note

⁽¹⁾ See "Voltage Proof Test for Metalized Film Capacitors" www.vishay.com/doc?28169

ELECTRICAL DATA AND ORDERING CODE						
U _{RDC} (V)	CAP. (μF)	DIMENSIONS w x h x l (mm)	MASS ⁽²⁾ (g)	CATALOG NUMBER BFC2 378 AND PACKAGING		
				LOOSE IN BOX		REEL ⁽¹⁾
				l _t = 3.5 mm ± 0.3 mm	ALL LEADS	H = 18.5 mm; P ₀ = 12.7 mm
				C-TOL. = ± 5 %		
LAST 5 DIGITS OF CATALOG NUMBER		SPQ	SPQ			
630	PITCH = 15.0 mm ± 0.4 mm; d _t = 0.60 ± 0.06 mm; U _{RAC} = 300 V; U _{p-p} = 850 V					
	0.015	5.0 x 11.0 x 17.5	1.0	64153	1000	1100
	0.016			64163		
	0.018			64183		
	0.020			64203		
	0.022			64223		
	0.024	5.0 x 11.0 x 17.5	1.4	64243	1000	900
	0.027			64273		
	0.030			64303		
	0.033			64333		
	0.036			6.0 x 12.0 x 17.5		
	0.039	64393				
	0.043	64433				
	0.047	7.0 x 13.0 x 17.5	2.4	64473	1000	650
	0.051			64513		
	PITCH = 22.5 mm ± 0.4 mm; d _t = 0.80 ± 0.08 mm; U _{RAC} = 300 V; U _{p-p} = 850 V					
	0.056	6.0 x 15.5 x 26.0	2.4	64563	300	600
	0.062			64623		
0.068	64683					
0.075	64753					
0.082	64823					
0.091	6.0 x 15.5 x 26.0	2.9	64913	200	550	
0.10			64104			
0.11			64114			
0.12	7.0 x 16.5 x 26.0	3.8	64124	200	450	
0.13			64134			
0.15			64154			
0.16	8.5 x 18.0 x 26.0	6.8	64164	200	350	
0.18			64184			



ELECTRICAL DATA AND ORDERING CODE						
U_{RDC} (V)	CAP. (μF)	DIMENSIONS w x h x l (mm)	MASS ⁽²⁾ (g)	CATALOG NUMBER BFC2 378 AND PACKAGING		
				LOOSE IN BOX		REEL ⁽¹⁾
				l_t = 3.5 mm ± 0.3 mm	ALL LEADS	H = 18.5 mm; P₀ = 12.7 mm
				C-TOL. = ± 5 %		
LAST 5 DIGITS OF CATALOG NUMBER	SPQ	SPQ				
PITCH = 27.5 mm ± 0.4 mm; d_t = 0.80 ± 0.08 mm; U_{RAC} = 300 V; U_{p-p} = 850 V						
630	0.20	9.0 x 19.0 x 31.5	7.4	64204	100	
	0.22			64224		
	0.24			64244		
	0.27			64274		
	0.30	11.0 x 21.0 x 31.0	9.2	64304	100	
	0.33			64334		
	0.36			64364		
	0.39			64394		
	0.43	13.0 x 23.0 x 31.0	12.3	64434	100	
	0.47			64474		
	0.51			64514		
	0.56	15.0 x 25.0 x 31.5	16.1	64564	100	
	0.62			64624		
	0.68			64684		

Notes

- (1) H = in-tape height; P₀ = sprocket hole distance; for detailed specifications refer to packaging information
- (2) Weight for short lead product only
- SPQ = Standard Packing Quantity

SPECIFIC REFERENCE DATA - 1000 V_{DC}		
DESCRIPTION	VALUE	
Tangent of loss angle:	at 10 kHz	at 100 kHz
C ≤ 0.051 μF	≤ 10 x 10 ⁻⁴	≤ 20 x 10 ⁻⁴
0.056 μF ≤ C ≤ 0.22 μF	≤ 10 x 10 ⁻⁴	≤ 25 x 10 ⁻⁴
Rated voltage pulse slope (dU/dt) _R :		
P = 15 mm	1300 V/μs	
P = 22.5 mm	1200 V/μs	
P = 27.5 mm	600 V/μs (b < 15 mm)	
P = 27.5 mm	300 V/μs (b ≥ 15 mm)	
R between leads, for C ≤ 1 μF; 500 V; 1 min	> 100 000 MΩ	
R between leads and case; 500 V; 1 min	> 100 000 MΩ	
Ionization (AC) voltage (typical value) at 50 pC peak discharge	> 500 V	
Withstanding (DC) voltage (cut off current 10 mA) ⁽¹⁾ ; rise time ≤ 1000 V/s	1600 V; 1 min	
Withstanding (DC) voltage between leads and case	2840 V; 1 min	

Note

- (1) See "Voltage Proof Test for Metalized Film Capacitors" www.vishay.com/doc?28169



ELECTRICAL DATA AND ORDERING CODE						
U _{RDC} (V)	CAP. (μF)	DIMENSIONS w x h x l (mm)	MASS ⁽²⁾ (g)	CATALOG NUMBER BFC2 378 AND PACKAGING		
				LOOSE IN BOX		REEL ⁽¹⁾
				l _t = 3.5 mm ± 0.3 mm	ALL LEADS	H = 18.5 mm; P ₀ = 12.7 mm
				C-TOL. = ± 5 %		
LAST 5 DIGITS OF CATALOG NUMBER	SPQ	SPQ				
1000	PITCH = 15.0 mm ± 0.4 mm; d _t = 0.60 ± 0.06 mm; U _{RAC} = 300 V; U _{p-p} = 1130 V					
	0.0030	5.0 x 11.0 x 17.5	1.0	74302	1000	1100
	0.0033			74332		
	0.0036			74362		
	0.0039			74392		
	0.0043			74432		
	0.0047			74472		
	0.0051			74512		
	0.0056			74562		
	0.0062			74622		
	0.0068			74682		
	0.0075			74752		
	0.0082	6.0 x 12.0 x 17.5	1.4	74822	1000	900
	0.0091			74912		
	0.010			74103		
	0.011	74113				
	PITCH = 22.5 mm ± 0.4 mm; d _t = 0.80 ± 0.08 mm; U _{RAC} = 300 V; U _{p-p} = 1130 V					
	0.012	6.0 x 15.5 x 26.0	2.4	74123	300	600
	0.013			74133		
	0.015			74153		
	0.016		74163			
	0.018		74183			
	0.020		74203			
	0.022	7.0 x 16.5 x 26.0	2.9	74223	200	550
	0.024			74243		
	0.027		3.8	74273	200	450
	0.030			74303		
	0.033	7.0 x 16.5 x 26.0	6.8	74333	200	350
	0.036			74363		
	0.039			74393		
	0.043	8.5 x 18.0 x 26.0	6.8	74433	200	350
	0.047			74473		
0.051	74513					
PITCH = 27.5 mm ± 0.4 mm; d _t = 0.80 ± 0.08 mm; U _{RAC} = 300 V; U _{p-p} = 1130 V						
0.056	9.0 x 19.0 x 31.5	7.4	74563	100		
0.062			74623			
0.068			74683			
0.075			74753			
0.082	11.0 x 21.0 x 31.5	9.2	74823	100		
0.091			74913			
0.10			74104			
0.11			74114			
0.12	13.0 x 23.0 x 31.0	12.3	74124	100		
0.13			74134			
0.15			74154			
0.16			74164			
0.18	15.0 x 25.0 x 31.5	16.1	74184	100		
0.20			74204			
0.22			74224			
0.22			74224			

Notes

- (1) H = in-tape height; P₀ = sprocket hole distance; for detailed specifications refer to packaging information
- (2) Weight for short lead product only
- SPQ = Standard Packing Quantity



SPECIFIC REFERENCE DATA - 1600 V _{DC}		
DESCRIPTION	VALUE	
Tangent of loss angle: C ≤ 0.022 μF 0.024 μF ≤ C ≤ 0.1 μF	at 10 kHz	at 100 kHz
	≤ 10 x 10 ⁻⁴	≤ 15 x 10 ⁻⁴
	≤ 10 x 10 ⁻⁴	≤ 20 x 10 ⁻⁴
Rated voltage pulse slope (dU/dt) _R : P = 22.5 mm P = 27.5 mm P = 27.5 mm	1600 V/μs 900 V/μs (b < 15 mm) 450 V/μs (b ≥ 15 mm)	
R between leads, for C ≤ 1 μF; 500 V; 1 min	> 100 000 MΩ	
R between leads and case; 500 V; 1 min	> 100 000 MΩ	
Ionization (AC) voltage (typical value) at 20 pC peak discharge	> 600 V	
Withstanding (DC) voltage (cut off current 10 mA) ⁽¹⁾ ; rise time ≤ 1000 V/s	2560 V; 1 min	
Withstanding (DC) voltage between leads and case	2840 V; 1 min	

Note

⁽¹⁾ See "Voltage Proof Test for Metalized Film Capacitors" www.vishay.com/doc?28169

ELECTRICAL DATA AND ORDERING CODE							
U _{RDC} (V)	CAP. (μF)	DIMENSIONS w x h x l (mm)	MASS ⁽²⁾ (g)	CATALOG NUMBER BFC2 378 AND PACKAGING			
				LOOSE IN BOX		REEL ⁽¹⁾	
				l _t = 3.5 mm ± 0.3 mm	ALL LEADS	H = 18.5 mm; P ₀ = 12.7 mm	
				C-TOL. = ± 5 %			
LAST 5 DIGITS OF CATALOG NUMBER		SPQ	SPQ				
1600	PITCH = 22.5 mm ± 0.4 mm; d_t = 0.80 ± 0.08 mm; U_{RAC} = 500 V; U_{p-p} = 1400 V						
	0.0056 0.0062 0.0068	6.0 x 15.5 x 26.0	2.4	84562	300	600	
	0.0075 0.0082 0.0091 0.010			2.9			84622
	0.011 0.012 0.013 0.015 0.016						3.8
	0.018 0.020 0.022		6.8		84752		
				84822			
				84912			
				84103			
				84113			
				84123			
				84133	200	450	
				84153			
				84163			
				84183			
				84203	200	350	
				84223			
		PITCH = 27.5 mm ± 0.4 mm; d_t = 0.80 ± 0.08 mm; U_{RAC} = 500 V; U_{p-p} = 1400 V					
	0.024 0.027 0.030 0.033 0.036	9.0 x 19.0 x 31.5	7.4	84243	100		
	0.039 0.043			9.2			84273
	0.047 0.051						84303
0.056 0.062 0.068	11.0 x 21.0 x 31.0	12.3	84333				
0.075			84363				
0.082 0.091			84393				
0.10	13.0 x 23.0 x 31.0	16.1	84433	100			
			84473				
			84513				
	15.0 x 25.0 x 31.5		84563	100			
			84623				
			84683				
			84753				
			84823				
			84913	100			
			84104				

Notes

- ⁽¹⁾ H = in-tape height; P₀ = sprocket hole distance; for detailed specifications refer to packaging information
- ⁽²⁾ Weight for short lead product only
- SPQ = Standard Packing Quantity



SPECIFIC REFERENCE DATA - 2000 V _{DC}		
DESCRIPTION	VALUE	
Tangent of loss angle: C ≤ 0.051 μF	at 10 kHz ≤ 10 x 10 ⁻⁴	at 100 kHz ≤ 15 x 10 ⁻⁴
Rated voltage pulse slope (dU/dt) _R : P = 22.5 mm P = 27.5 mm P = 27.5 mm	2000 V/μs 1200 V/μs (b < 15 mm) 600 V/μs (b ≥ 15 mm)	
R between leads, for C ≤ 1 μF; 500 V; 1 min	> 100 000 MΩ	
R between leads and case; 500 V; 1 min	> 100 000 MΩ	
Ionization (AC) voltage (typical value) at 20 pC peak discharge	> 600 V	
Withstanding (DC) voltage (cut off current 10 mA) ⁽¹⁾ ; rise time ≤ 1000 V/s	3200 V; 1 min	
Withstanding (DC) voltage between leads and case	2840 V; 1 min	

Note

(1) See "Voltage Proof Test for Metalized Film Capacitors" www.vishay.com/doc?28169

ELECTRICAL DATA AND ORDERING CODE										
U _{RDC} (V)	CAP. (μF)	DIMENSIONS w x h x l (mm)	MASS ⁽²⁾ (g)	CATALOG NUMBER BFC2 378 AND PACKAGING						
				LOOSE IN BOX		REEL ⁽¹⁾				
				I _t = 3.5 mm ± 0.3 mm	ALL LEADS	H = 18.5 mm; P ₀ = 12.7 mm				
				C-TOL. = ± 5 %						
LAST 5 DIGITS OF CATALOG NUMBER	SPQ	SPQ								
2000	PITCH = 22.5 mm ± 0.4 mm; d _t = 0.80 ± 0.08 mm; U _{RAC} = 600 V; U _{p-p} = 1700 V									
	0.0033 0.0036	6.0 x 12.0 x 26.0	2.4	94332 94362	300	600				
	0.0039 0.0043 0.0047 0.0051		2.9	94392 94432 94472 94512	200	550				
	0.0056						94562			
	0.0062 0.0068 0.0075						3.8	94622 94682 94752	200	450
	0.0082									
	0.0091 0.010 0.011	6.8	94912 94103 94113	200	350					
	0.012					94123				
	PITCH = 27.5 mm ± 0.4 mm; d _t = 0.80 ± 0.08 mm; U _{RAC} = 600 V; U _{p-p} = 1700 V									
	0.013 0.015 0.016	9.0 x 19.0 x 31.5	7.4	94133 94153 94163	100					
	0.018 0.020						11.0 x 21.0 x 31.0	94183 94203		
	0.022 0.024								9.2	94223 94243
	0.027	94273								
	0.030 0.033 0.036	13.0 x 23.0 x 31.0	12.3	94303 94333 94363	100					
	0.039 0.043 0.047						15.0 x 25.0 x 31.5	16.1	94393 94433 94473	100
	0.051									

Notes

- (1) H = in-tape height; P₀ = sprocket hole distance; for detailed specifications refer to packaging information
- (2) Weight for short lead product only
- SPQ = Standard Packing Quantity



MAXIMUM RMS VOLTAGE (SINEWAVE) AS A FUNCTION OF FREQUENCY

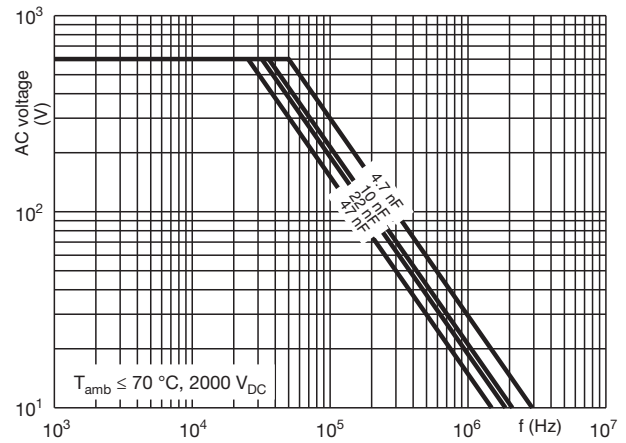
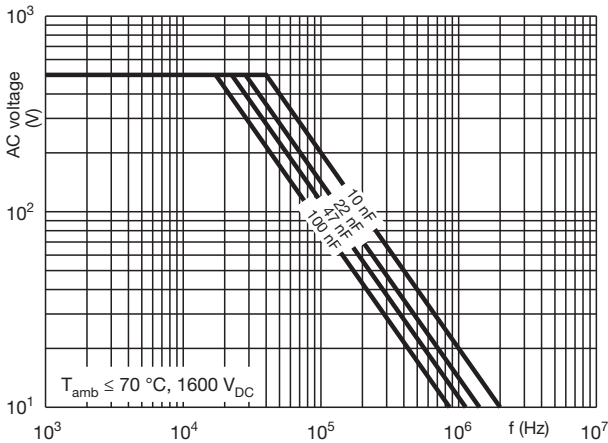
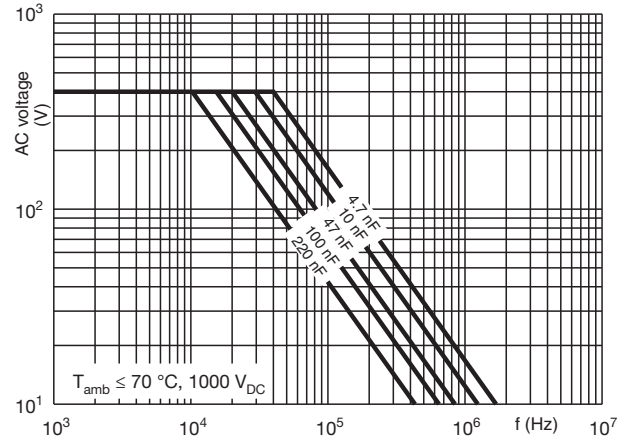
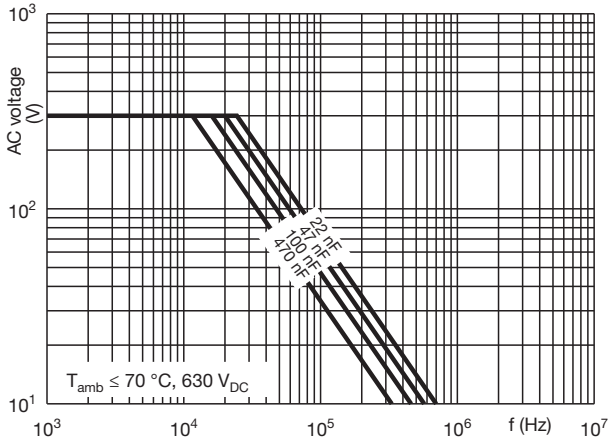

CAPACITANCE

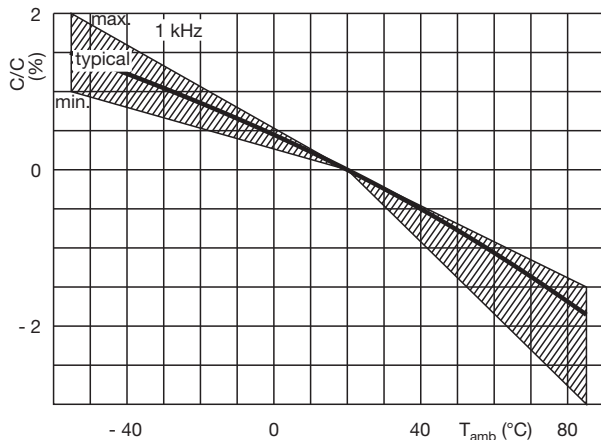

IMPEDANCE

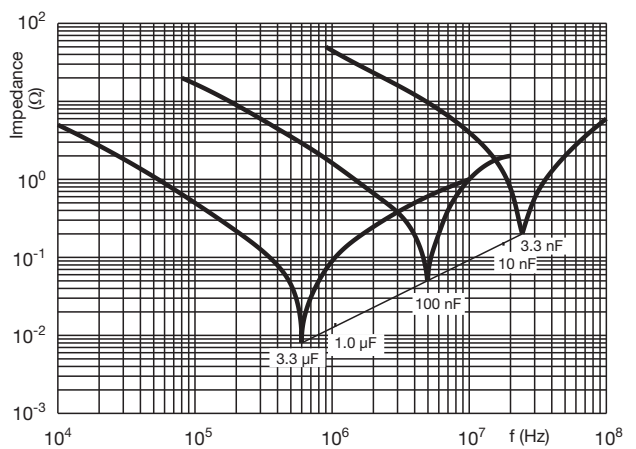



Disclaimer

ALL PRODUCT, PRODUCT SPECIFICATIONS AND DATA ARE SUBJECT TO CHANGE WITHOUT NOTICE TO IMPROVE RELIABILITY, FUNCTION OR DESIGN OR OTHERWISE.

Vishay Intertechnology, Inc., its affiliates, agents, and employees, and all persons acting on its or their behalf (collectively, "Vishay"), disclaim any and all liability for any errors, inaccuracies or incompleteness contained in any datasheet or in any other disclosure relating to any product.

Vishay makes no warranty, representation or guarantee regarding the suitability of the products for any particular purpose or the continuing production of any product. To the maximum extent permitted by applicable law, Vishay disclaims (i) any and all liability arising out of the application or use of any product, (ii) any and all liability, including without limitation special, consequential or incidental damages, and (iii) any and all implied warranties, including warranties of fitness for particular purpose, non-infringement and merchantability.

Statements regarding the suitability of products for certain types of applications are based on Vishay's knowledge of typical requirements that are often placed on Vishay products in generic applications. Such statements are not binding statements about the suitability of products for a particular application. It is the customer's responsibility to validate that a particular product with the properties described in the product specification is suitable for use in a particular application. Parameters provided in datasheets and / or specifications may vary in different applications and performance may vary over time. All operating parameters, including typical parameters, must be validated for each customer application by the customer's technical experts. Product specifications do not expand or otherwise modify Vishay's terms and conditions of purchase, including but not limited to the warranty expressed therein.

Hyperlinks included in this datasheet may direct users to third-party websites. These links are provided as a convenience and for informational purposes only. Inclusion of these hyperlinks does not constitute an endorsement or an approval by Vishay of any of the products, services or opinions of the corporation, organization or individual associated with the third-party website. Vishay disclaims any and all liability and bears no responsibility for the accuracy, legality or content of the third-party website or for that of subsequent links.

Vishay products are not designed for use in life-saving or life-sustaining applications or any application in which the failure of the Vishay product could result in personal injury or death unless specifically qualified in writing by Vishay. Customers using or selling Vishay products not expressly indicated for use in such applications do so at their own risk. Please contact authorized Vishay personnel to obtain written terms and conditions regarding products designed for such applications.

No license, express or implied, by estoppel or otherwise, to any intellectual property rights is granted by this document or by any conduct of Vishay. Product names and markings noted herein may be trademarks of their respective owners.