

## Interference Suppression Film Capacitor - Class X2 Radial MKP 310 V<sub>AC</sub> - Standard Across the Line

**FEATURES**

- 7.5 mm to 52.5 mm lead pitch
- Capacitance range up to 40  $\mu\text{F}$
- Very small dimensions
- Material categorization: for definitions of compliance please see [www.vishay.com/doc?99912](http://www.vishay.com/doc?99912)

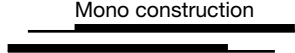

**RoHS  
COMPLIANT**
**APPLICATIONS**

For standard across the line X2 applications.  
See also application note: [www.vishay.com/doc?28153](http://www.vishay.com/doc?28153)

QUICK REFERENCE DATA		
Capacitance range (E12 series)	0.001 $\mu\text{F}$ to 40 $\mu\text{F}$ (preferred values according to E6)	
Capacitance tolerance	$\pm 20\%$ , $\pm 10\%$ , $\pm 5\%$	
Rated AC voltage	310 V <sub>AC</sub> , 50 Hz to 60 Hz	
Permissible DC voltage	For C $\leq 10\ \mu\text{F}$	For C > 10 $\mu\text{F}$
	800 V <sub>DC</sub> at 85 °C 630 V <sub>DC</sub> at 110 °C	575 V <sub>DC</sub> at 85 °C 450 V <sub>DC</sub> at 110 °C
Climatic testing class according to IEC 60068-1	55/110/56/B	
Maximum application temperature	110 °C	
Leads	Tinned wire	
Reference standards	IEC 60384-14 ed-4 (2013) and EN 60384-14 IEC 60065 requires pass. flamm. class B CSA-E384-14, UL 60384-14 CQC	
Dielectric	Polypropylene film	
Electrodes	Metallized	
Construction	Mono construction 	
Encapsulation	Plastic case, epoxy resin sealed, flame retardant UL-class 94 V-0	
Marking	C-value, tolerance, rated voltage, sub-class, manufacturer's type, code for dielectric material, manufacturer location, year and week; manufacturer's logo or name; safety approvals	

**Note**

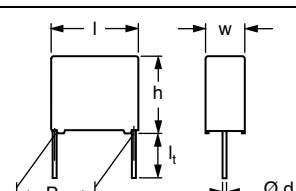
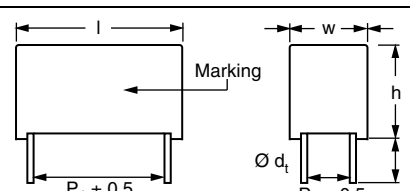
- For more detailed data and test requirements, contact [rfi@vishay.com](mailto:rfi@vishay.com)

DIMENSIONS in millimeters	
2 PINS	4 PINS
	

**Note**

- $\varnothing dt \pm 10\%$  of standard diameter specified



**COMPOSITION OF CATALOG NUMBER**



**Notes**

- For detailed tape specifications refer to Packaging Information: [www.vishay.com/doc?28139](http://www.vishay.com/doc?28139)
- Terminal codes see detail tables for 37.5 mm and 52.5 mm pitch
- <sup>(1)</sup> Packaging will be bulk for all capacitors with pitch ≤ 15 mm and such long leads (> 5 mm)  
Capacitors with short leads up to 5 mm and pitch > 15 mm will be in tray and asking code will be "T"



SPECIFIC REFERENCE DATA		
DESCRIPTION	VALUE	
Rated AC voltage ( $U_{RAC}$ )	310 V	
Permissible DC voltage ( $U_{RDC}$ )	630 V	
Tangent of loss angle:	at 1 kHz	at 10 kHz
$C < 470$ nF	$\leq 10 \times 10^{-4}$	$\leq 20 \times 10^{-4}$
$470$ nF $\leq C \leq 1$ $\mu$ F	$\leq 20 \times 10^{-4}$	$\leq 70 \times 10^{-4}$
$1$ $\mu$ F $\leq C \leq 20$ $\mu$ F	$\leq 30 \times 10^{-4}$	-
$C > 20$ $\mu$ F	$\leq 40 \times 10^{-4}$	-
Rated voltage pulse slope ( $dU/dt$ ) <sub>R</sub> at 435 V <sub>DC</sub>		
Pitch = 7.5 mm	600 V/ $\mu$ s	
Pitch = 10 mm	600 V/ $\mu$ s	
Pitch = 15 mm	400 V/ $\mu$ s	
Pitch = 22.5 mm	150 V/ $\mu$ s	
Pitch $\geq 27.5$ mm	100 V/ $\mu$ s	
R between leads, for $C \leq 0.33$ $\mu$ F at 100 V; 1 min	$> 15\,000$ M $\Omega$	
RC between leads, for $C > 0.33$ $\mu$ F at 100 V; 1 min	$> 5000$ s	
R between leads and case; 100 V; 1 min	$> 30\,000$ M $\Omega$	
Withstanding (DC) voltage (cut off current 10 mA) <sup>(1)</sup> ; rise time $\leq 1000$ V/s:		
$C \leq 1$ $\mu$ F	2200 V; 1 min	
$1$ $\mu$ F $< C \leq 10$ $\mu$ F	1800 V; 1 min	
$C > 10$ $\mu$ F	1500 V; 1 min	
Withstanding (AC) voltage between leads and case	2120 V; 1 min	
Maximum application temperature	110 °C	

Note

<sup>(1)</sup> See "Voltage Proof Test for Metallized Film Capacitors": [www.vishay.com/doc?28169](http://www.vishay.com/doc?28169)

ELECTRICAL DATA AND ORDERING CODE - PITCH 7.5 mm										
$U_{RAC}$ (V)	CAP. ( $\mu$ F)	DIMENSIONS w x h x l (mm)	MASS (g) <sup>(2)</sup>	CATALOG NUMBER F339MX2 ..... AND PACKAGING						
				LOOSE IN BOX					AMMOPACK <sup>(1)</sup>	
				SHORT LEADS			LONG LEADS		H = 18.5 mm P <sub>0</sub> = 12.7 mm	SPQ
				$l_t =$ 3.5 mm + 1 mm / - 0.5 mm	$l_t =$ 5.0 mm $\pm 1.0$ mm	SPQ	$l_t =$ 25.0 mm $\pm 2.0$ mm	SPQ		
PITCH = 7.5 mm $\pm 0.4$ mm; $d_t = 0.50$ mm $\pm 0.05$ mm; C-TOL. = $\pm 20$ %										
310	0.0010	4.0 x 9.0 x 10.0	0.4	21031MCA2B0	21031MCM2B0	1500	21031MCI2B0	1000	21031MC02G0	1250
	0.0015			21531MCA2B0	21531MCM2B0		21531MCI2B0		21531MC02G0	
	0.0022			22231MCA2B0	22231MCM2B0		22231MCI2B0		22231MC02G0	
	0.0033			23331MCA2B0	23331MCM2B0		23331MCI2B0		23331MC02G0	
	0.0047			24731MCA2B0	24731MCM2B0		24731MCI2B0		24731MC02G0	
	0.0068			26831MCA2B0	26831MCM2B0		26831MCI2B0		26831MC02G0	
	0.010			31031MCA2B0	31031MCM2B0		31031MCI2B0		31031MC02G0	
	0.015			31531MCA2B0	31531MCM2B0		31531MCI2B0		31531MC02G0	
	0.022			32231MCA2B0	32231MCM2B0		32231MCI2B0		32231MC02G0	
	0.033			33331MCA2B0	33331MCM2B0		33331MCI2B0		33331MC02G0	
	0.047			5.0 x 10.5 x 10.0	0.4		34731MCA2B0		34731MCM2B0	
0.068	6.0 x 11.5 x 10.0	0.8	36831MCA2B0	36831MCM2B0	750	36831MCI2B0	1000	36831MC02G0	750	



ELECTRICAL DATA AND ORDERING CODE - PITCH 7.5 mm										
U <sub>RAC</sub> (V)	CAP. (µF)	DIMENSIONS w x h x l (mm)	MASS (g) <sup>(2)</sup>	CATALOG NUMBER F339MX2 ..... AND PACKAGING						
				LOOSE IN BOX					AMMOPACK <sup>(1)</sup>	
				SHORT LEADS			LONG LEADS			
				$l_t =$ 3.5 mm + 1 mm / - 0.5 mm	$l_t =$ 5.0 mm ± 1.0 mm	SPQ	$l_t =$ 25.0 mm ± 2.0 mm	SPQ	H = 18.5 mm P <sub>0</sub> = 12.7 mm	SPQ
<b>PITCH = 7.5 mm ± 0.4 mm; d<sub>t</sub> = 0.50 mm ± 0.05 mm; C-TOL. = ± 10 %</b>										
310	0.0010	4.0 x 9.0 x 10.0	0.45	21031KCA2B0	21031KCM2B0	1500	21031KCI2B0	1000	21031KC02G0	1250
	0.0012			21231KCA2B0	21231KCM2B0		21231KCI2B0		21231KC02G0	
	0.0015			21531KCA2B0	21531KCM2B0		21531KCI2B0		21531KC02G0	
	0.0018			21831KCA2B0	21831KCM2B0		21831KCI2B0		21831KC02G0	
	0.0022			22231KCA2B0	22231KCM2B0		22231KCI2B0		22231KC02G0	
	0.0027			22731KCA2B0	22731KCM2B0		22731KCI2B0		22731KC02G0	
	0.0033			23331KCA2B0	23331KCM2B0		23331KCI2B0		23331KC02G0	
	0.0039			23931KCA2B0	23931KCM2B0		23931KCI2B0		23931KC02G0	
	0.0047			24731KCA2B0	24731KCM2B0		24731KCI2B0		24731KC02G0	
	0.0056			25631KCA2B0	25631KCM2B0		25631KCI2B0		25631KC02G0	
	0.0068			26831KCA2B0	26831KCM2B0		26831KCI2B0		26831KC02G0	
	0.0082			28231KCA2B0	28231KCM2B0		28231KCI2B0		28231KC02G0	
	0.010			31031KCA2B0	31031KCM2B0		31031KCI2B0		31031KC02G0	
	0.012			31231KCA2B0	31231KCM2B0		31231KCI2B0		31231KC02G0	
	0.015			31531KCA2B0	31531KCM2B0		31531KCI2B0		31531KC02G0	
	0.018			31831KCA2B0	31831KCM2B0		31831KCI2B0		31831KC02G0	
	0.022			32231KCA2B0	32231KCM2B0		32231KCI2B0		32231KC02G0	
	0.027			32731KCA2B0	32731KCM2B0		32731KCI2B0		32731KC02G0	
	0.033	5.0 x 10.5 x 10.0	0.6	33331KCA2B0	33331KCM2B0	1000	33331KCI2B0	1250	33331KC02G0	1000
	0.039			33931KCA2B0	33931KCM2B0		33931KCI2B0		33931KC02G0	
	0.047	6.0 x 11.5 x 10.0	0.8	34731KCA2B0	34731KCM2B0	750	34731KCI2B0	1000	34731KC02G0	750
	0.056			35631KCA2B0	35631KCM2B0		35631KCI2B0		35631KC02G0	
	<b>PITCH = 7.5 mm ± 0.4 mm; d<sub>t</sub> = 0.50 mm ± 0.05 mm; C-TOL. = ± 5 %</b>									
	310	0.0010	4.0 x 9.0 x 10.0	0.45	21031JCA2B0	21031JCM2B0	1500	21031JCI2B0	1000	21031JC02G0
0.0012		21231JCA2B0			21231JCM2B0	21231JCI2B0		21231JC02G0		
0.0015		21531JCA2B0			21531JCM2B0	21531JCI2B0		21531JC02G0		
0.0018		21831JCA2B0			21831JCM2B0	21831JCI2B0		21831JC02G0		
0.0022		22231JCA2B0			22231JCM2B0	22231JCI2B0		22231JC02G0		
0.0027		22731JCA2B0			22731JCM2B0	22731JCI2B0		22731JC02G0		
0.0033		23331JCA2B0			23331JCM2B0	23331JCI2B0		23331JC02G0		
0.0039		23931JCA2B0			23931JCM2B0	23931JCI2B0		23931JC02G0		
0.0047		24731JCA2B0			24731JCM2B0	24731JCI2B0		24731JC02G0		
0.0056		25631JCA2B0			25631JCM2B0	25631JCI2B0		25631JC02G0		
0.0068		26831JCA2B0			26831JCM2B0	26831JCI2B0		26831JC02G0		
0.0082		28231JCA2B0			28231JCM2B0	28231JCI2B0		28231JC02G0		
0.010		31031JCA2B0			31031JCM2B0	31031JCI2B0		31031JC02G0		
0.012		31231JCA2B0			31231JCM2B0	31231JCI2B0		31231JC02G0		
0.015		31531JCA2B0			31531JCM2B0	31531JCI2B0		31531JC02G0		
0.018		31831JCA2B0			31831JCM2B0	31831JCI2B0		31831JC02G0		
0.022		32231JCA2B0			32231JCM2B0	32231JCI2B0		32231JC02G0		
0.027		32731JCA2B0			32731JCM2B0	32731JCI2B0		32731JC02G0		
0.033		5.0 x 10.5 x 10.0	0.6	33331JCA2B0	33331JCM2B0	1000	33331JCI2B0	1250	33331JC02G0	1000
0.039				33931JCA2B0	33931JCM2B0		33931JCI2B0		33931JC02G0	
0.047		6.0 x 11.5 x 10.0	0.8	34731JCA2B0	34731JCM2B0	750	34731JCI2B0	1000	34731JC02G0	750
0.056				35631JCA2B0	35631JCM2B0		35631JCI2B0		35631JC02G0	

**Notes**

- SPQ = Standard Packing Quantity

(1) H = in-tape height; P<sub>0</sub> = sprocket hole distance; for detailed specifications refer to "Packaging Information" [www.vishay.com/doc?28139](http://www.vishay.com/doc?28139)

(2) Weight for short lead product only



ELECTRICAL DATA AND ORDERING CODE - PITCH 10 mm												
U <sub>RAC</sub> (V)	CAP. (μF)	DIMENSIONS w x h x l (mm)	MASS (g) <sup>(3)</sup>	CATALOG NUMBER F339MX2 ..... AND PACKAGING								
				LOOSE IN BOX					AMMOPACK <sup>(1)</sup>		REEL <sup>(1)(2)</sup>	
				SHORT LEADS			LONG LEADS					
				I <sub>t</sub> = 3.5 mm + 1 mm / - 0.5 mm	I <sub>t</sub> = 5.0 mm ± 1.0 mm	SPQ	I <sub>t</sub> = 25.0 mm ± 2.0 mm	SPQ	H = 18.5 mm P <sub>0</sub> = 12.7 mm	SPQ	Ø = 500 mm H = 18.5 mm P <sub>0</sub> = 15.0 mm	SPQ
<b>PITCH = 10.0 mm ± 0.4 mm; d<sub>t</sub> = 0.60 mm ± 0.06 mm; C-TOL. = ± 20 %</b>												
		4.0 x 10.0 x 12.5	0.6	21031MDA2B0	21031MDM2B0	1000	21031MDI2B0	1250	21031MD02G0	950		
0.0010				21531MDA2B0	21531MDM2B0		21531MDI2B0		21531MD02G0			
0.0015				22231MDA2B0	22231MDM2B0		22231MDI2B0		22231MD02G0			
0.0022				23331MDA2B0	23331MDM2B0		23331MDI2B0		23331MD02G0			
0.0033				24731MDA2B0	24731MDM2B0		24731MDI2B0		24731MD02G0			
0.0047				26831MDA2B0	26831MDM2B0		26831MDI2B0		26831MD02G0			
0.0068				31031MDA2B0	31031MDM2B0		31031MDI2B0		31031MD02G0			
0.010				31531MDA2B0	31531MDM2B0		31531MDI2B0		31531MD02G0			
0.015				32231MDA2B0	32231MDM2B0		32231MDI2B0		32231MD02G0			
0.022				33331MDA2B0	33331MDM2B0		33331MDI2B0		33331MD02G0			
0.033				34731MDA2B0	34731MDM2B0		34731MDI2B0		34731MD02G0			
0.047				36831MDA2B0	36831MDM2B0		36831MDI2B0		36831MD02G0			
0.068												
0.10	5.0 x 11.0 x 12.5			0.82	41031MDA2B0		41031MDM2B0		1000			41031MDI2B0
0.15	6.0 x 12.0 x 12.5	1.1	41531MDA2B0	41531MDM2B0	750	41531MDI2B0	750	41531MD02G0	600	41531MD02W0	1500	
<b>PITCH = 10.0 mm ± 0.4 mm; d<sub>t</sub> = 0.60 mm ± 0.06 mm; C-TOL. = ± 10 %</b>												
		4.0 x 10.0 x 12.5	0.6	21031KDA2B0	21031KDM2B0	1000	21031KDI2B0	1250	21031KD02G0	950		
0.0010				21231KDA2B0	21231KDM2B0		21231KDI2B0		21231KD02G0			
0.0012				21531KDA2B0	21531KDM2B0		21531KDI2B0		21531KD02G0			
0.0015				21831KDA2B0	21831KDM2B0		21831KDI2B0		21831KD02G0			
0.0018				22231KDA2B0	22231KDM2B0		22231KDI2B0		22231KD02G0			
0.0022				22731KDA2B0	22731KDM2B0		22731KDI2B0		22731KD02G0			
0.0027				23331KDA2B0	23331KDM2B0		23331KDI2B0		23331KD02G0			
0.0033				23931KDA2B0	23931KDM2B0		23931KDI2B0		23931KD02G0			
0.0039				24731KDA2B0	24731KDM2B0		24731KDI2B0		24731KD02G0			
0.0047				25631KDA2B0	25631KDM2B0		25631KDI2B0		25631KD02G0			
0.0056				26831KDA2B0	26831KDM2B0		26831KDI2B0		26831KD02G0			
0.0068				28231KDA2B0	28231KDM2B0		28231KDI2B0		28231KD02G0			
0.0082												
0.010				31031KDA2B0	31031KDM2B0		31031KDI2B0		31031KD02G0			
0.012		31231KDA2B0	31231KDM2B0	31231KDI2B0	31231KD02G0							
0.015		31531KDA2B0	31531KDM2B0	31531KDI2B0	31531KD02G0							
0.018		31831KDA2B0	31831KDM2B0	31831KDI2B0	31831KD02G0							
0.022		32231KDA2B0	32231KDM2B0	32231KDI2B0	32231KD02G0							
0.027		32731KDA2B0	32731KDM2B0	32731KDI2B0	32731KD02G0							
0.033		33331KDA2B0	33331KDM2B0	33331KDI2B0	33331KD02G0							
0.039		33931KDA2B0	33931KDM2B0	33931KDI2B0	33931KD02G0							
0.047		34731KDA2B0	34731KDM2B0	34731KDI2B0	34731KD02G0							
0.056	5.0 x 11.0 x 12.5	0.82	35631KDA2B0	35631KDM2B0	1100	35631KDI2B0	1000	35631KD02G0	750			
0.068			36831KDA2B0	36831KDM2B0		36831KDI2B0		36831KD02G0		36831KD02W0	1900	
0.082	6.0 x 12.0 x 12.5	1.1	38231KDA2B0	38231KDM2B0	750	38231KDI2B0	750	38231KD02G0	600	38231KD02W0	1500	
0.10			41031KDA2B0	41031KDM2B0		41031KDI2B0		41031KD02G0		41031KD02W0		



ELECTRICAL DATA AND ORDERING CODE - PITCH 10 mm																			
U <sub>RAC</sub> (V)	CAP. (μF)	DIMENSIONS w x h x l (mm)	MASS (g) <sup>(3)</sup>	CATALOG NUMBER F339MX2 ..... AND PACKAGING															
				LOOSE IN BOX				AMMOPACK <sup>(1)</sup>		REEL <sup>(1)(2)</sup>									
				SHORT LEADS		LONG LEADS													
				$l_t =$ 3.5 mm + 1 mm / - 0.5 mm	$l_t =$ 5.0 mm ± 1.0 mm	SPQ	$l_t =$ 25.0 mm ± 2.0 mm	SPQ	H = 18.5 mm P <sub>0</sub> = 12.7 mm	SPQ	Ø = 500 mm H = 18.5 mm P <sub>0</sub> = 15.0 mm	SPQ							
<b>PITCH = 10.0 mm ± 0.4 mm; d<sub>t</sub> = 0.60 mm ± 0.06 mm; C-TOL. = ± 5 %</b>																			
310	0.0010	4.0 x 10.0 x 12.5	0.6	21031JDA2B0	21031JDM2B0	1000	21031JDI2B0	21031JD02G0	1250	950	-	-							
	0.0012			21231JDA2B0	21231JDM2B0		21231JDI2B0	21231JD02G0											
	0.0015			21531JDA2B0	21531JDM2B0		21531JDI2B0	21531JD02G0											
	0.0018			21831JDA2B0	21831JDM2B0		21831JDI2B0	21831JD02G0											
	0.0022			22231JDA2B0	22231JDM2B0		22231JDI2B0	22231JD02G0											
	0.0027			22731JDA2B0	22731JDM2B0		22731JDI2B0	22731JD02G0											
	0.0033			23331JDA2B0	23331JDM2B0		23331JDI2B0	23331JD02G0											
	0.0039			23931JDA2B0	23931JDM2B0		23931JDI2B0	23931JD02G0											
	0.0047			24731JDA2B0	24731JDM2B0		24731JDI2B0	24731JD02G0											
	0.0056			25631JDA2B0	25631JDM2B0		25631JDI2B0	25631JD02G0											
	0.0068			26831JDA2B0	26831JDM2B0		26831JDI2B0	26831JD02G0											
	0.0082			28231JDA2B0	28231JDM2B0		28231JDI2B0	28231JD02G0											
	0.010			4.0 x 10.0 x 12.5	0.6		31031JDA2B0	31031JDM2B0					1000	31031JDI2B0	31031JD02G0	1250	950	-	-
	0.012						31231JDA2B0	31231JDM2B0						31231JDI2B0	31231JD02G0				
	0.015	31531JDA2B0	31531JDM2B0			31531JDI2B0	31531JD02G0												
	0.018	31831JDA2B0	31831JDM2B0			31831JDI2B0	31831JD02G0												
	0.022	32231JDA2B0	32231JDM2B0			32231JDI2B0	32231JD02G0												
	0.027	32731JDA2B0	32731JDM2B0			32731JDI2B0	32731JD02G0												
	0.033	33331JDA2B0	33331JDM2B0			33331JDI2B0	33331JD02G0												
	0.039	33931JDA2B0	33931JDM2B0			33931JDI2B0	33931JD02G0												
0.047	34731JDA2B0	34731JDM2B0	34731JDI2B0			34731JD02G0													
0.056	5.0 x 11.0 x 12.5	0.82	35631JDA2B0			35631JDM2B0	1000	35631JDI2B0	35631JD02G0	1000	750	-		-					
0.068			36831JDA2B0	36831JDM2B0	36831JDI2B0	36831JD02G0													
0.082	6.0 x 12.0 x 12.5	1.1	38231JDA2B0	38231JDM2B0	750	38231JDI2B0	38231JD02G0	750	600	38231JD02W0	1500								
0.10			41031JDA2B0	41031JDM2B0		41031JDI2B0	41031JD02G0					41031JD02W0							

**Notes**

- SPQ = Standard Packing Quantity
- (1) Reel diameter = 356 mm is available on request
- (2) H = in tape height; P<sub>0</sub> = sprocket hole distance; for detailed specifications refer to "Packaging Information" [www.vishay.com/doc?28139](http://www.vishay.com/doc?28139)
- (3) Weight for short lead product only



ELECTRICAL DATA AND ORDERING CODE - PITCH 15 mm										
U <sub>RAC</sub> (V)	CAP. (µF)	DIMENSIONS w x h x l (mm)	MASS (g) <sup>(3)</sup>	CATALOG NUMBER F339MX2 ..... AND PACKAGING						
				LOOSE IN BOX				REEL <sup>(1)(2)</sup>		
				SHORT LEADS		LONG LEADS				
				l <sub>t</sub> = 3.5 mm ± 0.3 mm	l <sub>t</sub> = 5.0 mm ± 1.0 mm	SPQ	l <sub>t</sub> = 25.0 mm ± 2.0 mm	SPQ	Ø = 500 mm H = 18.5 mm P <sub>0</sub> = 12.7 mm	SPQ
<b>PITCH = 15 mm ± 0.4 mm; d<sub>t</sub> = 0.60 mm ± 0.06 mm; C-TOL. = ± 20 %</b>										
310	0.010	5.0 x 11.0 x 17.5	1.0	31031MFP2B0	31031MFM2B0	1250	31031MFI2B0	1000	31031MF02W0	1100
	0.015			31531MFP2B0	31531MFM2B0		31531MFI2B0		31531MF02W0	
	0.022			32231MFP2B0	32231MFM2B0		32231MFI2B0		32231MF02W0	
	0.033			33331MFP2B0	33331MFM2B0		33331MFI2B0		33331MF02W0	
	0.047			34731MFP2B0	34731MFM2B0		34731MFI2B0		34731MF02W0	
	0.068			36831MFP2B0	36831MFM2B0		36831MFI2B0		36831MF02W0	
	0.10			41031MFP2B0	41031MFM2B0		41031MFI2B0		41031MF02W0	
	0.15			41531MFP2B0	41531MFM2B0		41531MFI2B0		41531MF02W0	
0.22	6.0 x 12.0 x 17.5	1.4	42231MFP2B0	42231MFM2B0	1000	42231MFI2B0	1000	42231MF02W0	900	
<b>PITCH = 15 mm ± 0.4 mm; d<sub>t</sub> = 0.80 mm ± 0.08 mm; C-TOL. = ± 20 %</b>										
	0.33	8.5 x 15.0 x 17.5	2.4	43331MFP2B0	43331MFM2B0	750	43331MFI2B0	500	43331MF02W0	650
	0.47	10.0 x 16.5 x 17.5	3.0	44731MFP2B0	44731MFM2B0	500	44731MFI2B0	450	44731MF02W0	600
	0.68	11.0 x 18.5 x 18.0	5.5	46831MFP2B0	46831MFM2B0	225	46831MFI2B0	350	46831MF02W0	-
<b>PITCH = 15 mm ± 0.4 mm; d<sub>t</sub> = 0.60 mm ± 0.06 mm; C-TOL. = ± 10 %</b>										
310	0.010	5.0 x 11.0 x 17.5	1.0	31031KFP2B0	31031KFM2B0	1250	31031KFI2B0	1000	31031KF02W0	1100
	0.012			31231KFP2B0	31231KFM2B0		31231KFI2B0		31231KF02W0	
	0.015			31531KFP2B0	31531KFM2B0		31531KFI2B0		31531KF02W0	
	0.018			31831KFP2B0	31831KFM2B0		31831KFI2B0		31831KF02W0	
	0.022			32231KFP2B0	32231KFM2B0		32231KFI2B0		32231KF02W0	
	0.027			32731KFP2B0	32731KFM2B0		32731KFI2B0		32731KF02W0	
	0.033			33331KFP2B0	33331KFM2B0		33331KFI2B0		33331KF02W0	
	0.039			33931KFP2B0	33931KFM2B0		33931KFI2B0		33931KF02W0	
	0.047			34731KFP2B0	34731KFM2B0		34731KFI2B0		34731KF02W0	
	0.056			35631KFP2B0	35631KFM2B0		35631KFI2B0		35631KF02W0	
	0.068			36831KFP2B0	36831KFM2B0		36831KFI2B0		36831KF02W0	
	0.082			38231KFP2B0	38231KFM2B0		38231KFI2B0		38231KF02W0	
	0.10			41031KFP2B0	41031KFM2B0		41031KFI2B0		41031KF02W0	
	0.12			41231KFP2B0	41231KFM2B0		41231KFI2B0		41231KF02W0	
	0.15	6.0 x 12.0 x 17.5	1.4	41531KFP2B0	41531KFM2B0	1000	41531KFI2B0	1000	41531KF02W0	900
	0.18			41831KFP2B0	41831KFM2B0		41831KFI2B0		41831KF02W0	
	<b>PITCH = 15 mm ± 0.4 mm; d<sub>t</sub> = 0.80 mm ± 0.08 mm; C-TOL. = ± 10 %</b>									
	0.22	7.0 x 13.5 x 17.5	1.8	42231KFP2B0	42231KFM2B0	750	42231KFI2B0	500	42231KF02W0	800
	0.27	8.5 x 15.0 x 17.5	2.4	42731KFP2B0	42731KFM2B0	750	42731KFI2B0	500	42731KF02W0	650
	0.33			43331KFP2B0	43331KFM2B0		43331KFI2B0		43331KF02W0	
	0.39	10.0 x 16.5 x 17.5	3.0	43931KFP2B0	43931KFM2B0	500	43931KFI2B0	450	43931KF02W0	600
	0.47			44731KFP2B0	44731KFM2B0		44731KFI2B0		44731KF02W0	
	0.56	11.0 x 18.5 x 18.0	5.5	45631KFP2B0	45631KFM2B0	225	45631KFI2B0	350	-	-



ELECTRICAL DATA AND ORDERING CODE - PITCH 15 mm										
U <sub>RAC</sub> (V)	CAP. (µF)	DIMENSIONS w x h x l (mm)	MASS (g) <sup>(3)</sup>	CATALOG NUMBER F339MX2 ..... AND PACKAGING						
				LOOSE IN BOX					REEL <sup>(1)(2)</sup>	
				SHORT LEADS			LONG LEADS			
				l <sub>t</sub> = 3.5 mm ± 0.3 mm	l <sub>t</sub> = 5.0 mm ± 1.0 mm	SPQ	l <sub>t</sub> = 25.0 mm ± 2.0 mm	SPQ	Ø = 500 mm H = 18.5 mm P <sub>0</sub> = 12.7 mm	SPQ
<b>PITCH = 15 mm ± 0.4 mm; d<sub>t</sub> = 0.60 mm ± 0.06 mm; C-TOL. = ± 5 %</b>										
310	0.010	5.0 x 11.0 x 17.5	1.0	31031JFP2B0	31031JFM2B0	1250	31031JFI2B0	1000	31031JF02W0	1100
	0.012			31231JFP2B0	31231JFM2B0		31231JFI2B0		31231JF02W0	
	0.015			31531JFP2B0	31531JFM2B0		31531JFI2B0		31531JF02W0	
	0.018			31831JFP2B0	31831JFM2B0		31831JFI2B0		31831JF02W0	
	0.022			32231JFP2B0	32231JFM2B0		32231JFI2B0		32231JF02W0	
	0.027			32731JFP2B0	32731JFM2B0		32731JFI2B0		32731JF02W0	
	0.033	5.0 x 11.0 x 17.5	1.0	33331JFP2B0	33331JFM2B0	1250	33331JFI2B0	1000	33331JF02W0	1100
	0.039			33931JFP2B0	33931JFM2B0		33931JFI2B0		33931JF02W0	
	0.047			34731JFP2B0	34731JFM2B0		34731JFI2B0		34731JF02W0	
	0.056			35631JFP2B0	35631JFM2B0		35631JFI2B0		35631JF02W0	
	0.068			36831JFP2B0	36831JFM2B0		36831JFI2B0		36831JF02W0	
	0.082			38231JFP2B0	38231JFM2B0		38231JFI2B0		38231JF02W0	
	0.10			41031JFP2B0	41031JFM2B0		41031JFI2B0		41031JF02W0	
	0.12			41231JFP2B0	41231JFM2B0		41231JFI2B0		41231JF02W0	
0.15	6.0 x 12.0 x 17.5	1.4	41531JFP2B0	41531JFM2B0	1000	41531JFI2B0	1000	41531JF02W0	900	
0.18			41831JFP2B0	41831JFM2B0		41831JFI2B0		41831JF02W0		
<b>PITCH = 15 mm ± 0.4 mm; d<sub>t</sub> = 0.80 mm ± 0.08 mm; C-TOL. = ± 5 %</b>										
	0.22	7.0 x 13.5 x 17.5	1.8	42231JFP2B0	42231JFM2B0	750	42231JFI2B0	500	42231JF02W0	800
	0.27	8.5 x 15.0 x 17.5	2.4	42731JFP2B0	42731JFM2B0	750	42731JFI2B0	500	42731JF02W0	650
	0.33			43331JFP2B0	43331JFM2B0		43331JFI2B0		43331JF02W0	
	0.39	10.0 x 16.5 x 17.5	3.0	43931JFP2B0	43931JFM2B0	500	43931JFI2B0	450	43931JF02W0	600
	0.47			44731JFP2B0	44731JFM2B0		44731JFI2B0		44731JF02W0	
	0.56	11.0 x 18.5 x 18.0	5.5	45631JFP2B0	45631JFM2B0	225	45631JFI2B0	350	-	-

**Notes**

- SPQ = Standard Packing Quantity
- (1) Reel diameter = 356 mm is available on request
- (2) H = in tape height; P<sub>0</sub> = sprocket hole distance; for detailed specifications refer to "Packaging Information" [www.vishay.com/doc?28139](http://www.vishay.com/doc?28139)
- (3) Weight for short lead product only





ELECTRICAL DATA AND ORDERING CODE - PITCH 22.5 mm										
U <sub>RAC</sub> (V)	CAP. (μF)	DIMENSIONS w x h x l (mm)	MASS (g) <sup>(2)</sup>	CATALOG NUMBER F339MX2 ..... AND PACKAGING						
				LOOSE IN BOX					REEL <sup>(1)(2)</sup>	
				SHORT LEADS			LONG LEADS			
				l <sub>t</sub> = 3.5 mm ± 0.3 mm	l <sub>t</sub> = 5.0 mm ± 1.0 mm	SPQ	l <sub>t</sub> = 25.0 mm ± 2.0 mm	SPQ	Ø = 500 mm H = 18.5 mm P <sub>0</sub> = 12.7 mm	SPQ
PITCH = 22.5 mm ± 0.4 mm; d <sub>t</sub> = 0.80 mm ± 0.08 mm; C-TOL. = ± 20 %										
0.15	6.0 x 15.5 x 26.0	2.4	41531MIP2T0	41531MIM2T0	300	41531MII2B0	250	41531MIO2W0	600	
0.22			42231MIP2T0	42231MIM2T0		42231MII2B0		42231MIO2W0		
0.33			43331MIP2T0	43331MIM2T0		43331MII2B0		43331MIO2W0		
0.47	7.0 x 16.5 x 26.0	2.9	44731MIP2T0	44731MIM2T0	200	44731MII2B0	250	44731MIO2W0	500	
0.68	8.5 x 18.0 x 26.0	3.8	46831MIP2T0	46831MIM2T0	200	46831MII2B0	250	46831MIO2W0	450	
1.0	10.0 x 19.5 x 26.0	6.8	51031MIP2T0	51031MIM2T0	200	51031MII2B0	200	51031MIO2W0	350	
1.5	12.0 x 22.0 x 26.0	10	51531MIP2T0	51531MIM2T0	150	51531MII2B0	200	51531MIO2W0	300	
2.2	12.5 x 22.5 x 26.5	11	52231MIP2T0	52231MIM2T0	110	52231MII2B0	275	52231MIO2W0	250	
PITCH = 22.5 mm ± 0.4 mm; d <sub>t</sub> = 0.80 mm ± 0.08 mm; C-TOL. = ± 10 %										
0.12	6.0 x 15.5 x 26.0	2.4	41231KIP2T0	41231KIM2T0	300	41231KII2B0	250	41231KIO2W0	600	
0.15			41531KIP2T0	41531KIM2T0		41531KII2B0		41531KIO2W0		
0.18			41831KIP2T0	41831KIM2T0		41831KII2B0		41831KIO2W0		
0.22			42231KIP2T0	42231KIM2T0		42231KII2B0		42231KIO2W0		
0.27			42731KIP2T0	42731KIM2T0		42731KII2B0		42731KIO2W0		
0.33			43331KIP2T0	43331KIM2T0		43331KII2B0		43331KIO2W0		
0.39	7.0 x 16.5 x 26.0	2.9	43931KIP2T0	43931KIM2T0	200	43931KII2B0	250	43931KIO2W0	500	
0.47			44731KIP2T0	44731KIM2T0		44731KII2B0		44731KIO2W0		
0.56	8.5 x 18.0 x 26.0	3.8	45631KIP2T0	45631KIM2T0	200	45631KII2B0	250	45631KIO2W0	450	
0.68			46831KIP2T0	46831KIM2T0		46831KII2B0		46831KIO2W0		
0.82	10.0 x 19.5 x 26.0	6.8	48231KIP2T0	48231KIM2T0	200	48231KII2B0	200	48231KIO2W0	350	
1.0	12.0 x 22.0 x 26.0	7.8	51031KIP2T0	51031KIM2T0	150	51031KII2B0	200	51031KIO2W0	300	
1.2			51231KIP2T0	51231KIM2T0		51231KII2B0		51231KIO2W0		
1.5			51531KIP2T0	51531KIM2T0		51531KII2B0		51531KIO2W0		
1.8			51831KIP2T0	51831KIM2T0		51831KII2B0		51831KIO2W0		
2.2	15.5 x 26.5 x 26.5	14	52231KIP2T0	52231KIM2T0	110	52231KII2B0	275	52231KIO2W0	250	
PITCH = 22.5 mm ± 0.4 mm; d <sub>t</sub> = 0.80 mm ± 0.08 mm; C-TOL. = ± 5 %										
0.12	6.0 x 15.5 x 26.0	2.4	41231JIP2T0	41231JIM2T0	300	41231JII2B0	250	41231JIO2W0	600	
0.15			41531JIP2T0	41531JIM2T0		41531JII2B0		41531JIO2W0		
0.18			41831JIP2T0	41831JIM2T0		41831JII2B0		41831JIO2W0		
0.22			42231JIP2T0	42231JIM2T0		42231JII2B0		42231JIO2W0		
0.27			42731JIP2T0	42731JIM2T0		42731JII2B0		42731JIO2W0		
0.33			43331JIP2T0	43331JIM2T0		43331JII2B0		43331JIO2W0		
0.39	7.0 x 16.5 x 26.0	2.9	43931JIP2T0	43931JIM2T0	200	43931JII2B0	250	43931JIO2W0	500	
0.47			44731JIP2T0	44731JIM2T0		44731JII2B0		44731JIO2W0		
0.56	8.5 x 18.0 x 26.0	3.8	45631JIP2T0	45631JIM2T0	200	45631JII2B0	250	45631JIO2W0	450	
0.68			46831JIP2T0	46831JIM2T0		46831JII2B0		46831JIO2W0		
0.82	10.0 x 19.5 x 26.0	6.8	48231JIP2T0	48231JIM2T0	200	48231JII2B0	200	48231JIO2W0	350	
1.0	12.0 x 22.0 x 26.0	7.8	51031JIP2T0	51031JIM2T0	150	51031JII2B0	200	51031JIO2W0	300	
1.2			51231JIP2T0	51231JIM2T0		51231JII2B0		51231JIO2W0		
1.5			51531JIP2T0	51531JIM2T0		51531JII2B0		51531JIO2W0		
1.8			51831JIP2T0	51831JIM2T0		51831JII2B0		51831JIO2W0		
2.2	15.5 x 26.5 x 26.5	14	52231JIP2T0	52231JIM2T0	110	52231JII2B0	275	52231JIO2W0	250	

Notes

• SPQ = Standard Packing Quantity

(1) Reel diameter = 356 mm is available on request

(2) H = in tape height; P<sub>0</sub> = sprocket hole distance; for detailed specifications refer to "Packaging Information" [www.vishay.com/doc?28139](http://www.vishay.com/doc?28139)

(3) Weight for short lead product only



ELECTRICAL DATA AND ORDERING CODE - PITCH 27.5 mm								
U <sub>RAC</sub> (V)	CAP. (μF)	DIMENSIONS w x h x l (mm)	MASS (g) <sup>(1)</sup>	CATALOG NUMBER F339MX2 ..... AND PACKAGING				
				LOOSE IN BOX				
				SHORT LEADS			LONG LEADS	
				l <sub>t</sub> = 3.5 mm ± 0.3 mm	l <sub>t</sub> = 5.0 mm ± 1.0 mm	SPQ	l <sub>t</sub> = 25.0 mm ± 2.0 mm	SPQ
<b>PITCH = 27.5 mm ± 0.4 mm; d<sub>t</sub> = 0.80 mm ± 0.08 mm; C-TOL. = ± 20 %</b>								
0.47	9.0 x 19.0 x 31.5	5.5	44731MKP2T0	44731MKM2T0	100	44731MKI2B0	150	
0.68			46831MKP2T0	46831MKM2T0		46831MKI2B0		
1.0			51031MKP2T0	51031MKM2T0		51031MKI2B0		
1.5	11.0 x 21.0 x 31.0	7.4	51531MKP2T0	51531MKM2T0	100	51531MKI2B0	125	
2.2	13.0 x 23.0 x 31.0	9.2	52231MKP2T0	52231MKM2T0	100	52231MKI2B0	125	
3.3	18.0 x 28.0 x 31.5	12.3	53331MKP2T0	53331MKM2T0	100	53331MKI2B0	100	
4.7	21.0 x 31.0 x 31.0	16.1	54731MKP2T0	54731MKM2T0	50	54731MKI2B0	75	
6.8	20.0 x 35.0 x 31.5	17.5	56831MKP2T0	56831MKM2T0	70	56831MKI2B0	150	
<b>PITCH = 27.5 mm ± 0.4 mm; d<sub>t</sub> = 0.80 mm ± 0.08 mm; C-TOL. = ± 10 %</b>								
0.39	9.0 x 19.0 x 31.5	5.5	43931KKP2T0	43931KKM2T0	100	43931KKI2B0	150	
0.47			44731KKP2T0	44731KKM2T0		44731KKI2B0		
0.56			45631KKP2T0	45631KKM2T0		45631KKI2B0		
0.68			46831KKP2T0	46831KKM2T0		46831KKI2B0		
0.82			48231KKP2T0	48231KKM2T0		48231KKI2B0		
1.0	11.0 x 21.0 x 31.0	7.4	51031KKP2T0	51031KKM2T0	100	51031KKI2B0	125	
1.2			51231KKP2T0	51231KKM2T0		51231KKI2B0		
1.5			51531KKP2T0	51531KKM2T0		51531KKI2B0		
1.8	13.0 x 23.0 x 31.0	9.2	51831KKP2T0	51831KKM2T0	100	51831KKI2B0	125	
2.2			52231KKP2T0	52231KKM2T0		52231KKI2B0		
2.7	15.0 x 25.0 x 31.5	12.3	52731KKP2T0	52731KKM2T0	100	52731KKI2B0	125	
3.3	18.0 x 28.0 x 31.5	16.1	53331KKP2T0	53331KKM2T0	100	53331KKI2B0	100	
3.9	21.0 x 31.0 x 31.0	20.3	53931KKP2T0	53931KKM2T0	50	53931KKI2B0	75	
4.7			54731KKP2T0	54731KKM2T0		54731KKI2B0		
5.6			55631KKP2T0	55631KKM2T0		55631KKI2B0		
<b>PITCH = 27.5 mm ± 0.4 mm; d<sub>t</sub> = 0.80 mm ± 0.08 mm; C-TOL. = ± 5 %</b>								
0.39	9.0 x 19.0 x 31.5	5.5	43931JKP2T0	43931JKM2T0	100	43931JKI2B0	150	
0.47			44731JKP2T0	44731JKM2T0		44731JKI2B0		
0.56			45631JKP2T0	45631JKM2T0		45631JKI2B0		
0.68			46831JKP2T0	46831JKM2T0		46831JKI2B0		
0.82			48231JKP2T0	48231JKM2T0		48231JKI2B0		
1.0	11.0 x 21.0 x 31.0	7.4	51031JKP2T0	51031JKM2T0	100	51031JKI2B0	125	
1.2			51231JKP2T0	51231JKM2T0		51231JKI2B0		
1.5			51531JKP2T0	51531JKM2T0		51531JKI2B0		
1.8	13.0 x 23.0 x 31.0	9.2	51831JKP2T0	51831JKM2T0	100	51831JKI2B0	125	
2.2			52231JKP2T0	52231JKM2T0		52231JKI2B0		
2.7	15.0 x 25.0 x 31.5	12.3	52731JKP2T0	52731JKM2T0	100	52731JKI2B0	125	
3.3	18.0 x 28.0 x 31.5	16.1	53331JKP2T0	53331JKM2T0	100	53331JKI2B0	100	
3.9	21.0 x 31.0 x 31.0	18.3	53931JKP2T0	53931JKM2T0	50	53931JKI2B0	75	
4.7			54731JKP2T0	54731JKM2T0		54731JKI2B0		
5.6			55631JKP2T0	55631JKM2T0		55631JKI2B0		

Notes

- SPQ = Standard Packing Quantity
- (1) Weight for short lead product only



<b>ELECTRICAL DATA AND ORDERING CODE - PITCH 37.5 mm / PITCH 52.5 mm (two pin version)</b>							
U <sub>RAC</sub> (V)	CAP. (μF)	DIMENSIONS w x h x l (mm)	MASS (g) <sup>(1)</sup>	CATALOG NUMBER F339MX2 ..... AND PACKAGING			
				LOOSE IN BOX			
				SHORT LEADS		LONG LEADS	
				l <sub>t</sub> = 5.0 mm ± 1.0 mm	SPQ	l <sub>t</sub> = 25.0 mm ± 2.0 mm	SPQ
<b>PITCH = 37.5 mm ± 0.5 mm; d<sub>t</sub> = 1.0 mm ± 0.1 mm; C-TOL. = ± 20 %</b>							
3.3	12.5 x 22.5 x 41.5	11.5	53331MPM2T0	90	53331MPI2T0	200	
4.7	14.5 x 24.5 x 41.5	14.5	54731MPM2T0	80	54731MPI2T0	175	
6.8	18.0 x 32.5 x 41.5	19.5	56831MPM2T0	60	56831MPI2T0	125	
10	18.5 x 35.5 x 43.0	30.0	61031MPM2T0	105	61031MPI2T0	105	
15	24.0 x 44.0 x 42.0	48.0	61531MPM2T0	77	61531MPI2T0	77	
20	30.0 x 45.0 x 42.0	64.0	62031MPM2T0	63	62031MPI2T0	63	
<b>PITCH = 37.5 mm ± 0.5 mm; d<sub>t</sub> = 1.0 mm ± 0.1 mm; C-TOL. = ± 10 %</b>							
3.3	14.5 x 24.5 x 41.5	15.5	53331KPM2T0	80	53331KPI2T0	175	
3.9	16.0 x 28.5 x 41.5	19.0	53931KPM2T0	70	53931KPI2T0	150	
4.7			54731KPM2T0		54731KPI2T0		
5.6	18.0 x 32.5 x 41.5	25.5	55631KPM2T0	60	55631KPI2T0	125	
6.8			56831KPM2T0		56831KPI2T0		
8.2	18.5 x 35.5 x 43.0	30.0	58231KPM2T0	105	58231KPI2T0	105	
10	21.5 x 38.5 x 42.0	37.5	61031KPM2T0	91	61031KPI2T0	91	
15	30.0 x 45.0 x 42.0	67.0	61531KPM2T0	63	61531KPI2T0	63	
<b>PITCH = 37.5 mm ± 0.5 mm; d<sub>t</sub> = 1.0 mm ± 0.1 mm; C-TOL. = ± 5 %</b>							
3.3	14.5 x 24.5 x 41.5	15.5	53331JPM2T0	80	53331JPI2T0	175	
3.9	16.0 x 28.5 x 41.5	19.0	53931JPM2T0	70	53931JPI2T0	150	
4.7			54731JPM2T0		54731JPI2T0		
5.6	18.0 x 32.5 x 41.5	25.5	55631JPM2T0	60	55631JPI2T0	125	
6.8			56831JPM2T0		56831JPI2T0		
8.2	18.5 x 35.5 x 43.0	30.0	58231JPM2T0	105	58231JPI2T0	105	
10	21.5 x 38.5 x 42.0	37.5	61031JPM2T0	91	61031JPI2T0	91	
15	30.0 x 45.0 x 42.0	67.0	61531JPM2T0	63	61531JPI2T0	63	
<b>PITCH = 52.5 mm ± 0.5 mm; d<sub>t</sub> = 1.2 mm ± 0.12 mm; C-TOL. = ± 20 %</b>							
20	25.0 x 45.0 x 57.5	69.0	62031MYM2T0	55	62031MYI2T0	55	
25		63.5	62531MYM2T0		62531MYI2T0		
30	30.0 x 45.0 x 57.5	85.0	63031MYM2T0	45	63031MYI2T0	45	
35	35.0 x 50.0 x 57.5	105.0	63531MYM2T0	40	63531MYI2T0	40	
40			64031MYM2T0		64031MYI2T0		
<b>PITCH = 52.5 mm ± 0.5 mm; d<sub>t</sub> = 1.2 mm ± 0.12 mm; C-TOL. = ± 10 %</b>							
20	25.0 x 45.0 x 57.5	65.5	62031KYM2T0	55	62031KYI2T0	55	
25	30.0 x 45.0 x 57.5	86.5	62531KYM2T0	45	62531KYI2T0	45	
30	35.0 x 50.0 x 57.5	105.0	63031KYM2T0	40	63031KYI2T0	40	
35			63531KYM2T0		63531KYI2T0		
<b>PITCH = 52.5 mm ± 0.5 mm; d<sub>t</sub> = 1.2 mm ± 0.12 mm; C-TOL. = ± 5 %</b>							
20	25.0 x 45.0 x 57.5	65.5	62031JYM2T0	55	62031JYI2T0	55	
25	30.0 x 45.0 x 57.5	86.5	62531JYM2T0	45	62531JYI2T0	45	
30	30.0 x 50.0 x 57.5	105.0	63031JYM2T0	40	63031JYI2T0	40	

310

**Notes**

- SPQ = Standard Packing Quantity
- <sup>(1)</sup> Weight for short lead product only



<b>ELECTRICAL DATA AND ORDERING CODE - PITCH 37.5 mm / PITCH 52.5 mm (four pin version)</b>							
U <sub>RAC</sub> (V)	CAP. (μF)	DIMENSIONS w x h x l (mm)	MASS (g) <sup>(1)</sup>	CATALOG NUMBER F339MX2 ..... AND PACKAGING			
				LOOSE IN BOX			
				SHORT LEADS		LONG LEADS	
				l <sub>t</sub> = 5.0 mm ± 1.0 mm	SPQ	l <sub>t</sub> = 25.0 mm ± 2.0 mm	SPQ
<b>PITCH P<sub>1</sub> = 37.5 mm ± 0.5 mm; P<sub>2</sub> = 10.2 mm ± 0.5 mm; d<sub>t</sub> = 1.0 mm ± 0.1 mm; C-TOL. = ± 20 %</b>							
10	18.5 x 35.5 x 43.0	30.0	61031MPM4T0	105	-	-	-
15	24.0 x 44.0 x 42.0	48.0	61531MPM4T0	77	-	-	-
20	30.0 x 45.0 x 42.0	64.0	62031MPM4T0	63	-	-	-
<b>PITCH P<sub>1</sub> = 37.5 mm ± 0.5 mm; P<sub>2</sub> = 20.3 mm ± 0.5 mm; d<sub>t</sub> = 1.0 mm ± 0.1 mm; C-TOL. = ± 20 %</b>							
20	30.0 x 45.0 x 42.0	64.0	62031MPM5T0	63	-	-	-
<b>PITCH P<sub>1</sub> = 37.5 mm ± 0.5 mm; P<sub>2</sub> = 10.2 mm ± 0.5 mm; d<sub>t</sub> = 1.0 mm ± 0.1 mm; C-TOL. = ± 10 %</b>							
10	21.5 x 38.5 x 42.0	37.5	61031KPM4T0	91	-	-	-
15	30.0 x 45.0 x 42.0	67.0	61531KPM4T0	63	-	-	-
<b>PITCH P<sub>1</sub> = 37.5 mm ± 0.5 mm; P<sub>2</sub> = 20.3 mm ± 0.5 mm; d<sub>t</sub> = 1.0 mm ± 0.1 mm; C-TOL. = ± 10 %</b>							
15	30.0 x 45.0 x 42.0	67.0	61531KPM5T0	63	-	-	-
<b>PITCH P<sub>1</sub> = 37.5 mm ± 0.5 mm; P<sub>2</sub> = 10.2 mm ± 0.5 mm; d<sub>t</sub> = 1.0 mm ± 0.1 mm; C-TOL. = ± 5 %</b>							
10	21.5 x 38.5 x 42.0	37.5	61031JPM4T0	91	-	-	-
15	30.0 x 45.0 x 42.0	67.0	61531JPM4T0	63	-	-	-
<b>PITCH P<sub>1</sub> = 37.5 mm ± 0.5 mm; P<sub>2</sub> = 20.3 mm ± 0.5 mm; d<sub>t</sub> = 1.0 mm ± 0.1 mm; C-TOL. = ± 5 %</b>							
15	30.0 x 45.0 x 42.0	67.0	61531JPM5T0	63	-	-	-
<b>PITCH P<sub>1</sub> = 52.5 mm ± 0.5 mm; P<sub>2</sub> = 10.2 mm ± 0.5 mm; d<sub>t</sub> = 1.2 mm ± 0.12 mm; C-TOL. = ± 20 %</b>							
310	25	25.0 x 45.0 x 57.5	69.0	62031MYM4T0	55	62031MYI4T0	55
			63.5	62531MYM4T0		62531MYI4T0	
	30	30.0 x 45.0 x 57.5	85.0	63031MYM4T0	45	63031MYI4T0	45
<b>PITCH P<sub>1</sub> = 52.5 mm ± 0.5 mm; P<sub>2</sub> = 20.3 mm ± 0.5 mm; d<sub>t</sub> = 1.2 mm ± 0.12 mm; C-TOL. = ± 20 %</b>							
30	30.0 x 45.0 x 57.5	85.0	63031MYM5T0	45	63031MYI5T0	45	
35	35.0 x 50.0 x 57.5	105.0	63531MYM5T0	40	63531MYI5T0	40	
40	35.0 x 50.0 x 57.5	105.0	64031MYM5T0	40	64031MYI5T0	40	
<b>PITCH P<sub>1</sub> = 52.5 mm ± 0.5 mm; P<sub>2</sub> = 10.2 mm ± 0.5 mm; d<sub>t</sub> = 1.2 mm ± 0.12 mm; C-TOL. = ± 10 %</b>							
20	25.0 x 45.0 x 57.5	65.5	62031KYM4T0	55	62031KYI4T0	55	
25	30.0 x 45.0 x 57.5	86.5	62531KYM4T0	45	62531KYI4T0	45	
<b>PITCH P<sub>1</sub> = 52.5 mm ± 0.5 mm; P<sub>2</sub> = 20.3 mm ± 0.5 mm; d<sub>t</sub> = 1.2 mm ± 0.12 mm; C-TOL. = ± 10 %</b>							
25	30.0 x 45.0 x 57.5	86.5	62531KYM5T0	45	62531KYI5T0	45	
30	35.0 x 50.0 x 57.5	105.0	63031KYM5T0	40	63031KYI5T0	40	
			63531KYM5T0		63531KYI5T0		
<b>PITCH P<sub>1</sub> = 52.5 mm ± 0.5 mm; P<sub>2</sub> = 10.2 mm ± 0.5 mm; d<sub>t</sub> = 1.2 mm ± 0.12 mm; C-TOL. = ± 5 %</b>							
20	25.0 x 45.0 x 57.5	65.5	62031JYM4T0	55	62031JYI4T0	55	
25	30.0 x 45.0 x 57.5	86.5	62531JYM4T0	45	62531JYI4T0	45	
<b>PITCH P<sub>1</sub> = 52.5 mm ± 0.5 mm; P<sub>2</sub> = 20.3 mm ± 0.5 mm; d<sub>t</sub> = 1.2 mm ± 0.12 mm; C-TOL. = ± 5 %</b>							
25	30.0 x 45.0 x 57.5	86.5	62531JYM5T0	45	62531JYI5T0	45	
30	35.0 x 50.0 x 57.5	105.0	63031JYM5T0	40	63031JYI5T0	40	

**Notes**

- SPQ = Standard Packing Quantity
- <sup>(1)</sup> Weight for short lead product only

<b>APPROVALS</b>				
<b>SAFETY APPROVALS X2</b>	<b>VOLTAGE</b>	<b>VALUE</b>	<b>FILE NUMBERS</b>	<b>LINK</b>
EN 60384-14 (ENEC) (= IEC 60384-14 ed-4 (2013))	310 V <sub>AC</sub>	1 nF to 40 μF	40028493	<a href="http://www.vishay.com/doc?28215">www.vishay.com/doc?28215</a>
UL 60384-14	310 V <sub>AC</sub>	1 nF to 40 μF	E354331	<a href="http://www.vishay.com/doc?28216">www.vishay.com/doc?28216</a>
CSA-E384-14	310 V <sub>AC</sub>	1 nF to 40 μF	E354331	
CQC	310 V <sub>AC</sub>	1 nF to 40 μF	10001041904 (L)	<a href="http://www.vishay.com/doc?28217">www.vishay.com/doc?28217</a>
			10001041903 (F)	<a href="http://www.vishay.com/doc?28237">www.vishay.com/doc?28237</a>
CB - Test certificate	310 V <sub>AC</sub>	1 nF to 40 μF	DE-41725	<a href="http://www.vishay.com/doc?28214">www.vishay.com/doc?28214</a>
The ENEC-approval together with the CB-Certificate replace all national marks of the following countries (they have already signed the ENEC-Agreement): Austria; Belgium; Czech.Republic; Denmark; Finland; France; Germany; Greece; Hungary; Ireland; Italy; Luxembourg; Netherlands; Norway; Portugal; Slovenian; Spain; Sweden; Switzerland and United Kingdom.				

## MOUNTING

### Normal Use

The capacitors are designed for mounting on printed-circuit boards. The capacitors packed in bandoliers are designed for mounting in printed circuit boards by means of automatic insertion machines.

For detailed tape specifications refer to Packaging Information: [www.vishay.com/doc?28139](http://www.vishay.com/doc?28139)

### Specific Method of Mounting to Withstand Vibration and Shock

In order to withstand vibration and shock tests, it must be ensured that the stand-off pips are in good contact with the printed-circuit board:

- For pitches  $\leq 15$  mm capacitors shall be mechanically fixed by the leads
- For larger pitches the capacitors shall be mounted in the same way and the body clamped in addition

### Space Requirements on Printed Circuit-Board

The maximum space for length ( $l_{max.}$ ), width ( $W_{max.}$ ), and height ( $h_{max.}$ ) of film capacitors to take in account on the printed circuit board is shown in the drawings:

- For products with pitch  $\leq 15$  mm,  $\Delta w = \Delta l = 0.3$  mm and  $\Delta h = 0.1$  mm
- For products with  $15$  mm  $<$  pitch  $\leq 27.5$  mm,  $\Delta w = \Delta l = 0.5$  mm and  $\Delta h = 0.1$  mm
- For products with pitch = 37.5 mm,  $\Delta w = \Delta l = 0.7$  mm;  $\Delta h = 0.5$  mm
- For products with pitch = 52.5 mm,  $\Delta w = \Delta l = 1.0$  mm and  $\Delta h = 0.5$  mm

Eccentricity defined as in drawing. The maximum eccentricity is smaller than or equal to the lead diameter of the product concerned.

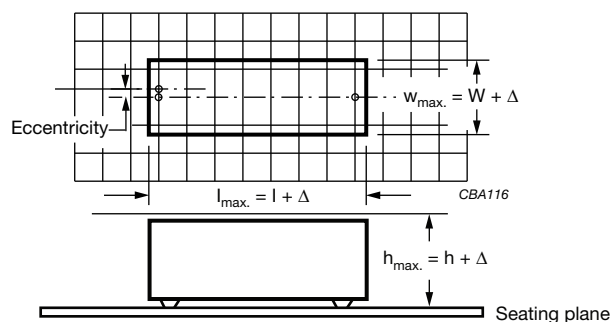

## SOLDERING CONDITIONS

For general soldering conditions and wave soldering profile, we refer to the application note: "Soldering Guidelines for Film Capacitors": [www.vishay.com/doc?28171](http://www.vishay.com/doc?28171)

### Storage Temperature

- $T_{stg} = -25$  °C to  $+35$  °C with RH maximum 75 % without condensation

### Ratings and Characteristics Reference Conditions

Unless otherwise specified, all electrical values apply to an ambient free air temperature of  $23$  °C  $\pm 1$  °C, an atmospheric pressure of 86 kPa to 106 kPa and a relative humidity of  $50$  %  $\pm 2$  %.

For reference testing, a conditioning period shall be applied over  $96$  h  $\pm 4$  h by heating the products in a circulating air oven at the rated temperature and a relative humidity not exceeding 20 %.



CHARACTERISTICS

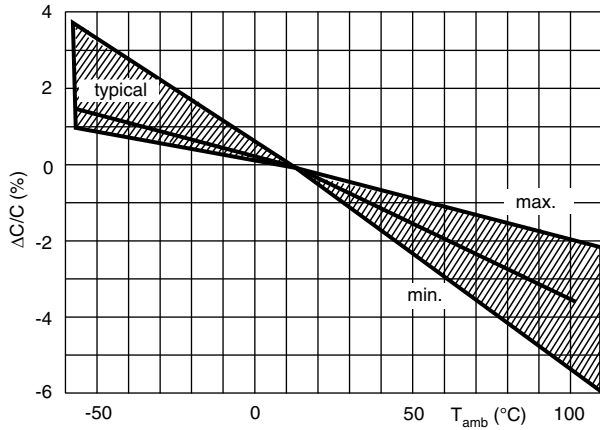

Capacitance as a function of ambient temperature (typical curve)

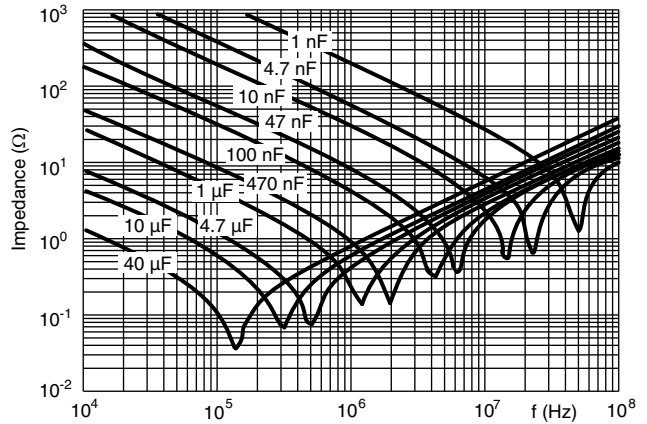

Impedance as a function of frequency (typical curve)

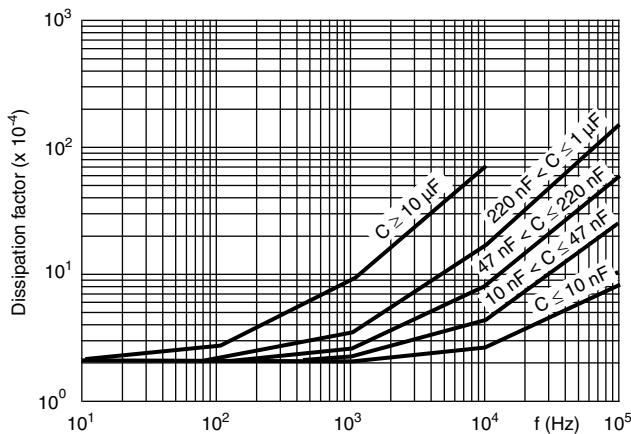

Tangent of loss angle as a function of frequency (typical curve)

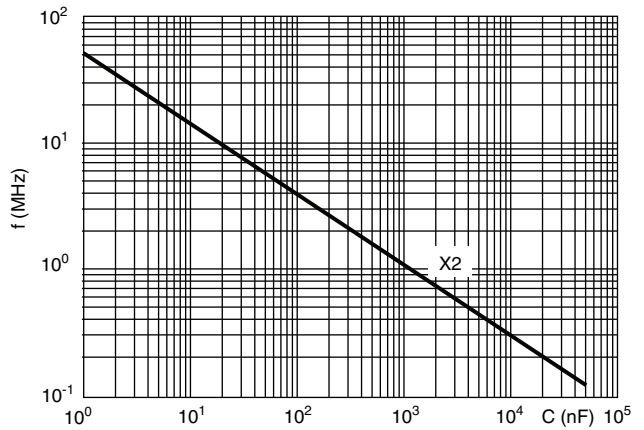

Resonant frequency as a function of capacitance (typical curve)

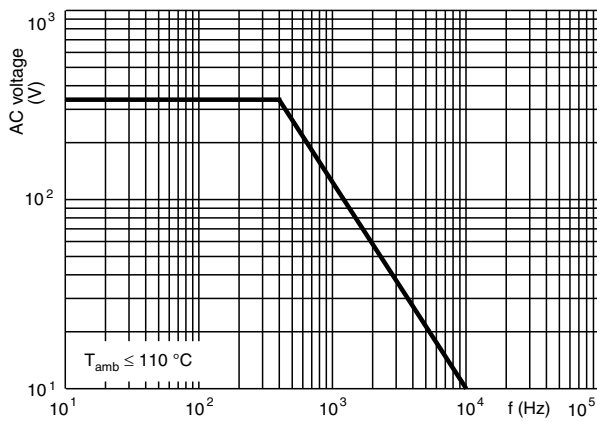

Max. RMS voltage as a function of frequency

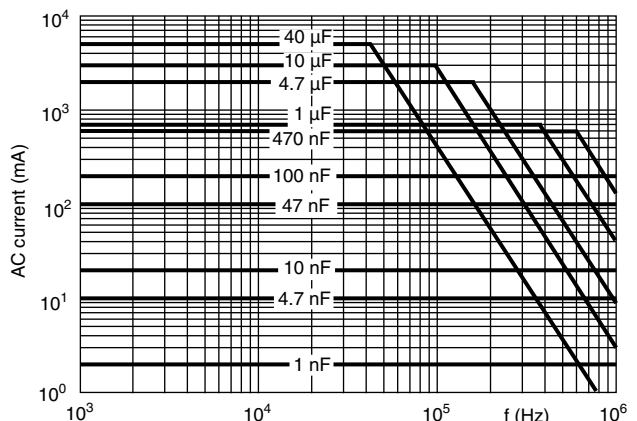

Max. RMS current as a function of frequency

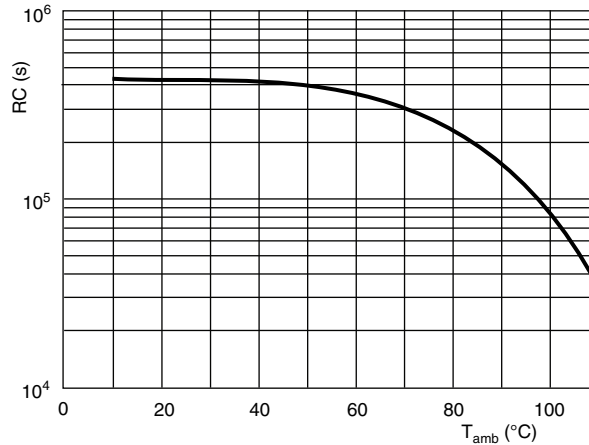
**CHARACTERISTICS**

 Insulation resistance as a function of ambient temperature  
(typical curve)

**APPLICATION NOTES**

- For X2 electromagnetic interference suppression in **standard across the line applications** (50 Hz / 60 Hz) with a maximum mains voltage of 310 V<sub>AC</sub>.
- For series impedance applications we refer to application note [www.vishay.com/doc?28153](http://www.vishay.com/doc?28153)
- For capacitors connected in parallel, normally the proof voltage and possibly the rated voltage must be reduced. For information depending of the capacitance value and the number of parallel connections contact: [rfi@vishay.com](mailto:rfi@vishay.com)
- These capacitors are not intended for continuous pulse application. For these situations capacitors of the AC and pulse programs must be used.
- The maximum ambient temperature must not exceed 110 °C.
- Rated voltage pulse slope:  
if the pulse voltage is lower than the rated voltage, the values of the specific reference data can be multiplied by 435 V<sub>DC</sub> and divided by the applied voltage

**INSPECTION REQUIREMENTS**
**General Notes**

Sub-clause numbers of tests and performance requirements refer to the “Sectional Specification, IEC 60384-14 ed-4 (2013) and Specific Reference Data.

<b>GROUP C INSPECTION REQUIREMENTS</b>		
<b>SUB-CLAUSE NUMBER AND TEST</b>	<b>CONDITIONS</b>	<b>PERFORMANCE REQUIREMENTS</b>
<b>SUB-GROUP C1A PART OF SAMPLE OF SUB-GROUP C1</b>		
4.1 Dimensions (detail)  Initial measurements	Capacitance Tangent of loss angle: for C ≤ 1 μF at 10 kHz or for C > 1 μF at 1 kHz	As specified in chapters “General data” of this specification
4.3 Robustness of terminations	Tensile: load 10 N; 10 s Bending: load 5 N; 4 x 90°	No visible damage
4.4 Resistance to soldering heat	No pre-drying Method: 1A Solder bath: 280 °C ± 5 °C Duration: 10 s	
4.19 Component solvent resistance	Isopropylalcohol at room temperature Method: 2 Immersion time: 5 min ± 0.5 min Recovery time: Min. 1 h, max. 2 h	





GROUP C INSPECTION REQUIREMENTS		
SUB-CLAUSE NUMBER AND TEST	CONDITIONS	PERFORMANCE REQUIREMENTS
<b>SUB-GROUP C1A PART OF SAMPLE OF SUB-GROUP C1</b>		
4.4.2 Final measurements	<p>Visual examination</p> <p>Capacitance</p> <p>Tangent of loss angle</p> <p>Insulation resistance</p>	<p>No visible damage Legible marking</p> <p><math> \Delta C/C  \leq 5\%</math> of the value measured initially</p> <p>Increase of <math>\tan \delta</math>:  <math>\leq 0.008</math> for: <math>C \leq 1 \mu\text{F}</math> or  <math>\leq 0.005</math> for: <math>C &gt; 1 \mu\text{F}</math>                      Compared to values measured initially</p> <p>As specified in section "Insulation Resistance" of this specification</p>
<b>SUB-GROUP C1B PART OF SAMPLE OF SUB-GROUP C1</b>		
Initial measurements	<p>Capacitance</p> <p>Tangent of loss angle:                      for <math>C \leq 1 \mu\text{F}</math> at 10 kHz or                      for <math>C &gt; 1 \mu\text{F}</math> at 1 kHz</p>	
4.20 Solvent resistance of the marking	<p>Isopropylalcohol at room temperature                      Method: 1                      Rubbing material: cotton wool                      Immersion time: 5 min <math>\pm</math> 0.5 min</p>	<p>No visible damage                      Legible marking</p>
4.6 Rapid change of temperature	<p><math>\theta A = -55\text{ }^\circ\text{C}</math>  <math>\theta B = +125\text{ }^\circ\text{C}</math></p>	
4.6.1 Inspection	<p>5 cycles                      Duration <math>t = 30</math> min</p>	<p>No visible damage</p>
4.7 Vibration	<p>Visual examination                      Mounting: see section "Mounting" of this specification                      Procedure B4                      Frequency range: 10 Hz to 55 Hz                      Amplitude: 0.75 mm or                      Acceleration 98 m/s<sup>2</sup>                      (whichever is less severe)                      Total duration 6 h</p>	
4.7.2 Final inspection	<p>Visual examination</p>	<p>No visible damage</p>
4.9 Shock	<p>Mounting: see section "Mounting" for more information                      Pulse shape: half sine                      Acceleration: 490 m/s<sup>2</sup>                      Duration of pulse: 11 ms</p>	
4.9.2 Final measurements	<p>Visual examination</p> <p>Capacitance</p> <p>Tangent of loss angle</p> <p>Insulation resistance</p>	<p>No visible damage</p> <p><math> \Delta C/C  \leq 5\%</math> of the value measured initially.</p> <p>Increase of <math>\tan \delta</math>:  <math>\leq 0.008</math> for: <math>C \leq 1 \mu\text{F}</math> or  <math>\leq 0.005</math> for: <math>C &gt; 1 \mu\text{F}</math>                      Compared to values measured initially</p> <p>As specified in section "Insulation Resistance" of this specification</p>





GROUP C INSPECTION REQUIREMENTS		
SUB-CLAUSE NUMBER AND TEST	CONDITIONS	PERFORMANCE REQUIREMENTS
<b>SUB-GROUP C1 COMBINED SAMPLE OF SPECIMENS OF SUB-GROUPS C1A AND C1B</b>		
4.11 Climatic sequence		
4.11.1 Initial measurements	Capacitance Measured in 4.4.2 and 4.9.2 Tangent of loss angle: measured initially in C1A and C1B	
4.11.2 Dry heat	Temperature: 110 °C Duration: 16 h	
4.11.3 Damp heat cyclic Test Db First cycle		
4.11.4 Cold	Temperature: -55 °C Duration: 2 h	
4.11.5 Damp heat cyclic Test Db Remaining cycles		
4.11.6 Final measurements	Visual examination  Capacitance  Tangent of loss angle  Voltage proof 1350 V <sub>DC</sub> ; 1 min between terminations  Insulation resistance	No visible damage  Legible marking  ΔC/C  ≤ 5 % of the value measured in 4.11.1.  Increase of tan δ: ≤ 0.008 for: C ≤ 1 μF or ≤ 0.005 for: C > 1 μF Compared to values measured in 4.11.1.  No permanent breakdown or flash-over  ≥ 50 % of values specified in section “Insulation Resistance” of this specification
<b>SUB-GROUP C2</b>		
4.12 Damp heat steady state	56 days; 40 °C; 90 % to 95 % RH no load	
4.12.1 Initial measurements	Capacitance Tangent of loss angle: at 1 kHz	
4.12.3 Final measurements	Visual examination  Capacitance  Tangent of loss angle  Voltage proof 1350 V <sub>DC</sub> ; 1 min between terminations  Insulation resistance	No visible damage Legible marking   ΔC/C  ≤ 5 % of the value measured in 4.12.1.  Increase of tan δ: ≤ 0.008 for: C ≤ 1 μF or ≤ 0.005 for: C > 1 μF Compared to values measured in 4.12.1.  No permanent breakdown or flash-over  ≥ 50 % of values specified in section “Insulation Resistance” of this specification

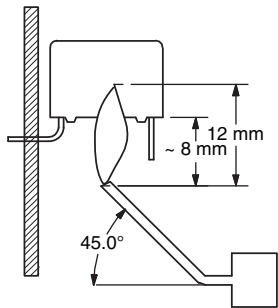

GROUP C INSPECTION REQUIREMENTS		
SUB-CLAUSE NUMBER AND TEST	CONDITIONS	PERFORMANCE REQUIREMENTS
<b>SUB-GROUP C3</b>		
4.13.1 Initial measurements	Capacitance Tangent of loss angle: for C ≤ 1 μF at 10 kHz or for C > 1 μF at 1 kHz	
4.13 Impulse voltage	3 successive impulses, full wave, peak voltage: X2: 2.5 kV for C ≤ 1 μF X2: 2.5 kV/√C for C > 1 μF Max. 24 pulses	No self healing breakdowns or flash-over
4.14 Endurance	Duration: 1000 h 1.25 x U <sub>RAC</sub> at 110 °C Once in every hour the voltage is increased to 1000 V <sub>RMS</sub> for 0.1 s via resistor of 47 Ω ± 5 %	
4.14.7 Final measurements	Visual examination  Capacitance  Tangent of loss angle  Voltage proof 1350 V <sub>DC</sub> ; 1 min between terminations 2120 V <sub>AC</sub> ; 1 min between terminations and case  Insulation resistance	No visible damage Legible marking   ΔC/C  ≤ 10 % compared to values measured in 4.13.1.  Increase of tan δ: ≤ 0.008 for: C ≤ 1 μF or ≤ 0.005 for: C > 1 μF Compared to values measured in 4.13.1.  No permanent breakdown or flash-over  ≥ 50 % of values specified in section "Insulation Resistance" of this specification
<b>SUB-GROUP C4</b>		
4.15 Charge and discharge	10 000 cycles Charged to 435 V <sub>DC</sub> Discharge resistance: $R = \frac{435 V_{DC}}{1.25 \times C (dU/dt)}$ R = 2.2 Ω for pitch 37.5 mm and 52.5 mm	
4.15.1 Initial measurements	Capacitance Tangent of loss angle: for C ≤ 1 μF at 10 kHz or for C > 1 μF at 1 kHz	
4.15.3 Final measurements	Capacitance  Tangent of loss angle  Insulation resistance	ΔC/C  ≤ 10 % compared to values measured in 4.15.1.  Increase of tan δ: ≤ 0.008 for: C ≤ 1 μF or ≤ 0.005 for: C > 1 μF Compared to values measured in 4.15.1.  ≥ 50 % of values specified in section "Insulation Resistance" of this specification

<b>GROUP C INSPECTION REQUIREMENTS</b>		
<b>SUB-CLAUSE NUMBER AND TEST</b>	<b>CONDITIONS</b>	<b>PERFORMANCE REQUIREMENTS</b>
<b>SUB-GROUP C5</b>		
4.16 Radio frequency characteristic	Resonance frequency	$\geq 0.9$ times the value as specified in section "Resonant Frequency" of this specification
<b>SUB-GROUP C6</b>		
4.17 Passive flammability Class B	Bore of gas jet: $\varnothing 0.5$ mm Fuel: butane Test duration for actual volume $V$ in $\text{mm}^3$ : $V \leq 250$ : 10 s $250 < V \leq 500$ : 20 s $500 < V \leq 1750$ : 30 s $V > 1750$ : 60 s One flame application 	After removing test flame from capacitor, the capacitor must not continue to burn for more than 10 s. No burning particle must drop from the sample.
<b>SUB-GROUP C7</b>		
4.18 Active flammability	20 cycles of 2.5 kV discharges on the test capacitor connected to $U_{RAC}$	The cheese cloth around the capacitors shall not burn with a flame. No electrical measurements are required.



## Disclaimer

ALL PRODUCT, PRODUCT SPECIFICATIONS AND DATA ARE SUBJECT TO CHANGE WITHOUT NOTICE TO IMPROVE RELIABILITY, FUNCTION OR DESIGN OR OTHERWISE.

Vishay Intertechnology, Inc., its affiliates, agents, and employees, and all persons acting on its or their behalf (collectively, "Vishay"), disclaim any and all liability for any errors, inaccuracies or incompleteness contained in any datasheet or in any other disclosure relating to any product.

Vishay makes no warranty, representation or guarantee regarding the suitability of the products for any particular purpose or the continuing production of any product. To the maximum extent permitted by applicable law, Vishay disclaims (i) any and all liability arising out of the application or use of any product, (ii) any and all liability, including without limitation special, consequential or incidental damages, and (iii) any and all implied warranties, including warranties of fitness for particular purpose, non-infringement and merchantability.

Statements regarding the suitability of products for certain types of applications are based on Vishay's knowledge of typical requirements that are often placed on Vishay products in generic applications. Such statements are not binding statements about the suitability of products for a particular application. It is the customer's responsibility to validate that a particular product with the properties described in the product specification is suitable for use in a particular application. Parameters provided in datasheets and / or specifications may vary in different applications and performance may vary over time. All operating parameters, including typical parameters, must be validated for each customer application by the customer's technical experts. Product specifications do not expand or otherwise modify Vishay's terms and conditions of purchase, including but not limited to the warranty expressed therein.

Hyperlinks included in this datasheet may direct users to third-party websites. These links are provided as a convenience and for informational purposes only. Inclusion of these hyperlinks does not constitute an endorsement or an approval by Vishay of any of the products, services or opinions of the corporation, organization or individual associated with the third-party website. Vishay disclaims any and all liability and bears no responsibility for the accuracy, legality or content of the third-party website or for that of subsequent links.

Vishay products are not designed for use in life-saving or life-sustaining applications or any application in which the failure of the Vishay product could result in personal injury or death unless specifically qualified in writing by Vishay. Customers using or selling Vishay products not expressly indicated for use in such applications do so at their own risk. Please contact authorized Vishay personnel to obtain written terms and conditions regarding products designed for such applications.

No license, express or implied, by estoppel or otherwise, to any intellectual property rights is granted by this document or by any conduct of Vishay. Product names and markings noted herein may be trademarks of their respective owners.