

AC and Pulse Metallized Polypropylene Film Capacitors MKP Axial Type

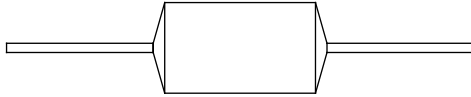

FEATURES

- Precision capacitor, tolerance 1 % and 2 %. Intermediate values are available of the E96 series
- Material categorization:
For definitions of compliance please see www.vishay.com/doc?99912



RoHS
COMPLIANT
HALOGEN
FREE
GREEN
(5-2008)

APPLICATIONS

- Pulse operations
- SMPS and thyristor circuits
- Storage, filter, timing and sample and hold circuits

QUICK REFERENCE DATA	
Capacitance range (E12 series)	47 pF to 22 μF
Capacitance tolerance	± 10 %, ± 5 %, ± 2.5 %, ± 2 %, ± 1 %
Climatic testing class according to IEC 60068-1	55/100/56
Maximum application temperature	100 °C
Reference standards	IEC 60384-16
Dielectric	Polypropylene film
Electrodes	Metallized
Construction	Mono construction
Encapsulation	Plastic-wrapped, epoxy resin sealed. Flame retardant
Leads	Tinned wire
Marking	C-value; tolerance; rated voltage; manufacturer's type; code for dielectric material; manufacturer location, year and week; manufacturer's logo or name
Rated DC voltage	160 V _{DC} , 250 V _{DC} , 400 V _{DC} , 630 V _{DC}
Rated AC voltage	100 V _{AC} , 160 V _{AC} , 220 V _{AC} , 250 V _{AC}
Pull test on leads	≥ 20 N in direction of leads according to IEC 60068-2-21
Bent test on leads	2 bends through 90° with half of the force used in pull test

Note

- For more detailed data and test requirements, contact dc-film@vishay.com

DIMENSIONS in millimeters		
LEAD DIAMETER d_t	D	L
0.6 ± 0.06	≤ 9.0	≤ 19.0
0.8 ± 0.08	< 16.5	> 26.5
1.0 ± 0.1	> 16.5	> 26.5

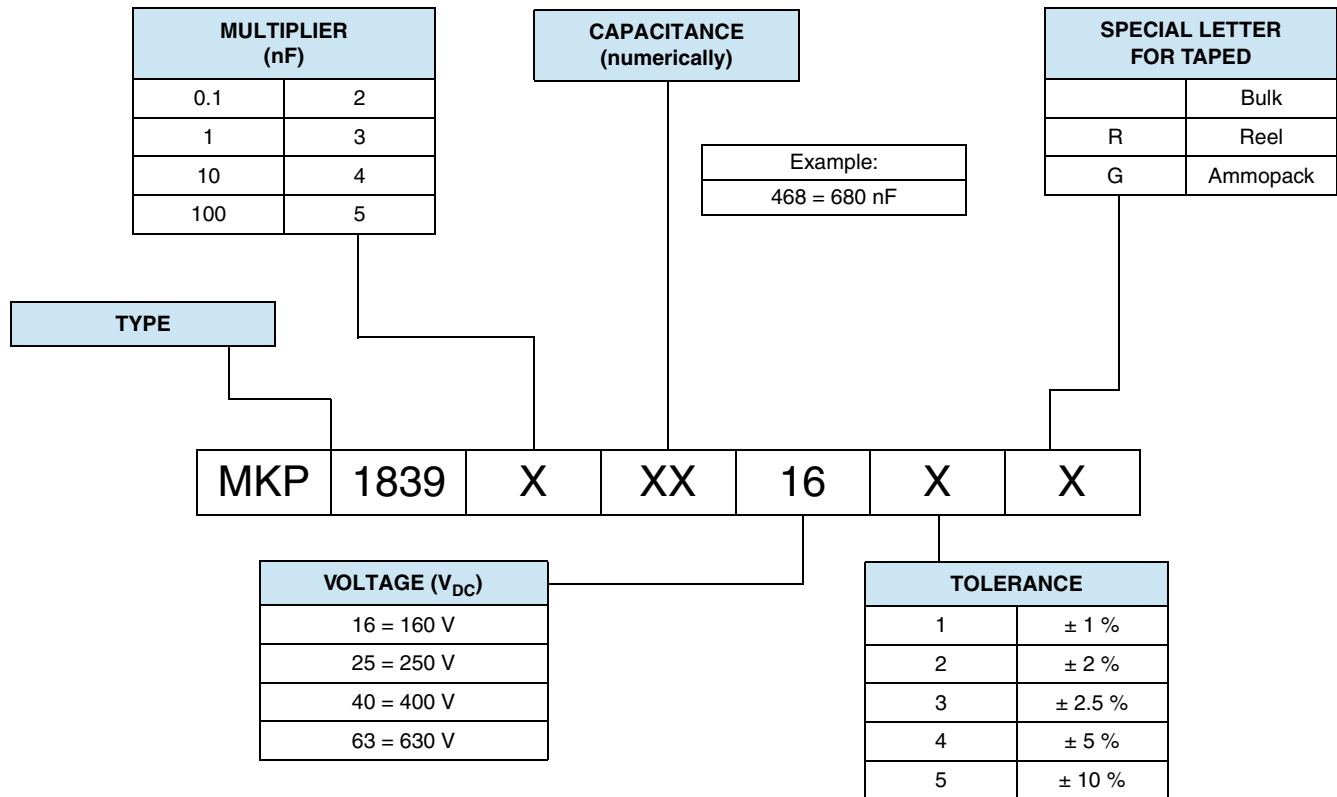
COMPOSITION OF CATALOG NUMBER

Note

 (1) For detailed tape specifications refer to packaging information: www.vishay.com/doc?28139 or end of catalog

SPECIFIC REFERENCE DATA				
DESCRIPTION	VALUE			
Tangent of loss angle: C ≤ 0.1 μF 0.1 μF < C ≤ 1.0 μF C > 1.0 μF	at 1 kHz	at 10 kHz	at 100 kHz	
	4 × 10 ⁻⁴	6 × 10 ⁻⁴	40 × 10 ⁻⁴	
	4 × 10 ⁻⁴	6 × 10 ⁻⁴	-	
	10 × 10 ⁻⁴	-	-	
CAPACITOR LENGTH (mm)	MAXIMUM PULSE RISE TIME (dU/dt) _R [V/μs]			
	160 V _{DC}	250 V _{DC}	400 V _{DC}	630 V _{DC}
11	240	300	515	700
14	175	220	380	510
19	100	125	200	280
26.5	60	75	120	160
31.5	45	60	95	120
41.5	30	40	65	85
If the maximum pulse voltage is less than the rated voltage higher dU/dt values can be permitted.				
R between leads, for C ≤ 0.33 μF at 100 V, 1 min			> 100 000 MΩ	
RC between leads, for C > 0.33 μF at 100 V, 1 min			> 30 000 s	
R between leads and case, 100 V, 1 min			> 30 000 mΩ	
Withstanding (DC) voltage between leads and wrapped film (1.4 × U _{RAC} + 2000)			2840 V, 1 min	
Withstanding (DC) voltage (cut off current 10 mA), rise time 100 V/s			1.6 × U _{RDC} , 1 min	
Maximum application temperature			100 °C	



ELECTRICAL DATA						
U _{RDC} (V)	CAP. (µF)	CAPACITANCE CODE	VOLTAGE CODE	V _{AC}	DIMENSIONS	
					D	L
160	0.033	333	16	100	5.0	11.0
	0.047	347			5.5	11.0
	0.068	368			6.0	11.0
	0.10	410			6.5	14.0
	0.15	415			7.5	14.0
	0.22	422			7.0	19.0
	0.33	433			8.0	19.0
	0.47	447			9.0	19.0
	0.68	468			8.5	26.5
	1.0	510			10.5	26.5
	1.5	515			12.0	26.5
	2.2	522			13.0	31.5
	3.3	533			15.5	31.5
	4.7	547			15.5	41.5
	6.8	568			18.5	41.5
	10	610			22.0	41.5
15	615	24.5	41.5			
22	622	28.5	41.5			
250	0.010	310	25	160	5.0	11.0
	0.015	315			5.0	11.0
	0.022	322			5.0	11.0
	0.033	333			5.5	11.0
	0.047	347			6.0	14.0
	0.068	368			6.5	14.0
	0.10	410			7.5	14.0
	0.15	415			7.0	19.0
	0.22	422			8.5	19.0
	0.33	433			8.0	26.5
	0.47	447			9.0	26.5
	0.68	468			11.0	26.5
	1.0	510			12.5	26.5
	1.5	515			13.0	31.5
	2.2	522			16.0	31.5
	3.3	533			19.0	31.5
4.7	547	19.5	41.5			
6.8	568	23.0	41.5			
10	610	22.0	41.5			
15	615	24.5	41.5			
22	622	28.5	41.5			
400	0.0068	268	40	220 ⁽¹⁾	5.0	11.0
	0.0082	282			5.0	11.0
	0.010	310			5.5	11.0
	0.015	315			6.0	11.0
	0.022	322			6.5	14.0
	0.033	333			7.0	14.0
	0.047	347			8.0	14.0
	0.068	368			8.5	19.0
	0.10	410			9.0	19.0
	0.15	415			8.0	26.5
	0.22	422			9.5	26.5
	0.33	433			11.5	26.5
	0.47	447			13.5	26.5
	0.68	468			14.0	31.5
	1.0	510			17.0	31.5
	1.5	515			20.5	31.5
2.2	522	21.0	41.5			



ELECTRICAL DATA						
U _{RDC} (V)	CAP. (μF)	CAPACITANCE CODE	VOLTAGE CODE	V _{AC}	DIMENSIONS	
					D	L
630	0.000047	047	63	250 ⁽¹⁾	5.0	11.0
	0.000051	051			5.0	11.0
	0.000056	056			5.0	11.0
	0.000062	056			5.0	11.0
	0.000068	068			5.5	11.0
	0.000075	075			5.5	11.0
	0.000082	082			5.5	11.0
	0.000091	091			6.0	11.0
	0.00010	110			6.0	11.0
	0.00011	111			6.0	11.0
	0.00012	112			6.0	11.0
	0.00013	113			6.0	11.0
	0.00015	115			6.0	11.0
	0.00016	116			6.0	11.0
	0.00018	118			6.0	11.0
	0.00020	120			6.0	11.0
	0.00022	122			5.0	11.0
	0.00024	124			5.0	11.0
	0.00027	127			5.0	11.0
	0.00030	130			5.0	11.0
	0.00033	133			5.0	11.0
	0.00036	136			5.0	11.0
	0.00039	139			5.0	11.0
	0.00043	143			5.0	11.0
	0.00047	147			5.0	11.0
	0.00051	151			5.0	11.0
	0.00056	156			5.5	11.0
	0.00062	162			5.5	11.0
	0.00068	168			5.5	11.0
	0.00075	175			5.5	11.0
	0.00082	182			5.0	11.0
	0.00091	191			5.0	11.0
	0.0010	210			5.0	11.0
	0.0011	211			5.0	11.0
	0.0012	212			5.0	11.0
	0.0013	213			5.0	11.0
	0.0015	215			5.0	11.0
	0.0016	216			5.0	11.0
	0.0018	218			5.0	11.0
	0.0020	220			5.0	11.0
	0.0022	222			5.0	11.0
	0.0024	224			5.0	11.0
	0.0027	227			5.0	11.0
	0.0030	230			5.0	11.0
	0.0033	233			5.0	11.0
	0.0036	236			5.0	11.0
	0.0039	239			5.0	11.0
0.0043	243	5.0	11.0			
0.0047	247	5.0	11.0			
0.0062	262	5.5	11.0			
0.0068	268	5.5	11.0			
0.0082	282	6.0	11.0			
0.010	310	5.5	14.0			
0.015	315	6.5	14.0			
0.022	322	7.5	14.0			
0.033	333	7.0	19.0			
0.047	347	8.0	19.0			

ELECTRICAL DATA						
U _{RDC} (V)	CAP. (μF)	CAPACITANCE CODE	VOLTAGE CODE	V _{AC}	DIMENSIONS	
					D	L
630	0.068	368	63	250 ⁽¹⁾	9.0	19.0
	0.10	410			8.5	26.5
	0.15	415			10.5	26.5
	0.22	422			12.0	26.5
	0.33	433			14.5	26.5
	0.47	447			15.0	31.5
	0.68	468			18.0	31.5
	1.0	510			18.0	41.5
	1.5	515			22.0	41.5

Notes

- Pitch = L + 3.5 mm
- ⁽¹⁾ Not suitable for mains applications

RECOMMENDED PACKAGING				
PACKAGING CODE	TYPE OF PACKAGING	REEL DIAMETER (mm)	ORDERING CODE EXAMPLES	
G	Ammo	-	MKP1839422403G	x
R	Reel	350	MKP1839422403R	x
-	Bulk for L > 31.5 mm	-	MKP1839522403	x

Note

- For detailed tape specifications refer to packaging information: www.vishay.com/doc?28139

MOUNTING
Normal Use

The capacitors are designed for mounting on printed-circuit boards. The capacitors packed in bandoliers are designed for mounting in printed-circuit boards by means of automatic insertion machines.

For detailed tape specifications refer to packaging information: www.vishay.com/doc?28139

Specific Method of Mounting to Withstand Vibration and Shock

In order to withstand vibration and shock tests, it must be ensured that the capacitors body is in good contact with the printed-circuit board.

- For L < 19 mm capacitors shall be mechanically fixed by the leads
- For larger pitches the capacitors shall be mounted in the same way and the body clamped
- The maximum diameter and length of the capacitors are specified in the dimensions table
- Eccentricity as shown in the drawing below

Space Requirements on Printed-Circuit Board

The maximum length and width of film capacitors is shown in drawing:

- Eccentricity as in drawing. The maximum eccentricity is smaller than or equal to the lead diameter of the product concerned.
- Product height with seating plane as given by IEC 60717 as reference: $h_{max.} \leq h + 0.4$ mm or $h_{max.} \leq h' + 0.4$ mm

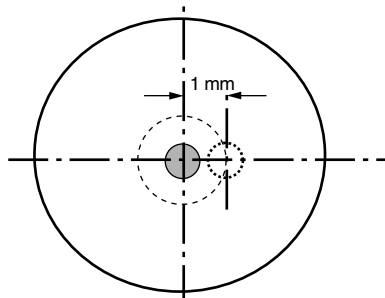



SOLDERING CONDITIONS

For general soldering conditions and wave soldering profile, we refer to application note: "Soldering Guidelines for Film Capacitors": www.vishay.com/doc?28171

Storage Temperature

Tstg = - 25 °C to + 35 °C with RH maximum 75 % without condensation

Ratings and Characteristics Reference Conditions

Unless otherwise specified, all electrical values apply to an ambient temperature of 23 °C ± 1 °C, an atmospheric pressure of 86 kPa to 106 kPa and a relative humidity of 50 % ± 2 %.

For reference testing, a conditioning period shall be applied over 96 h ± 4 h by heating the products in a circulating air oven at the rated temperature and a relative humidity not exceeding 20 %.

CHARACTERISTICS

MAX. RMS VOLTAGE AS A FUNCTION OF FREQUENCY

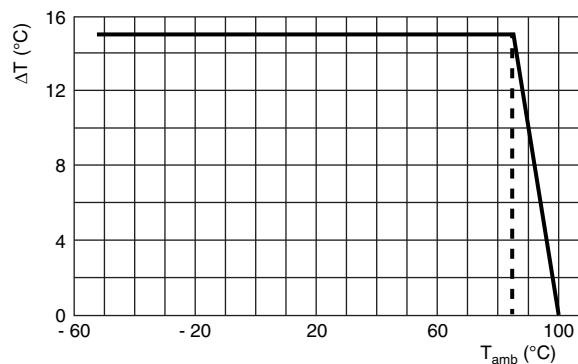
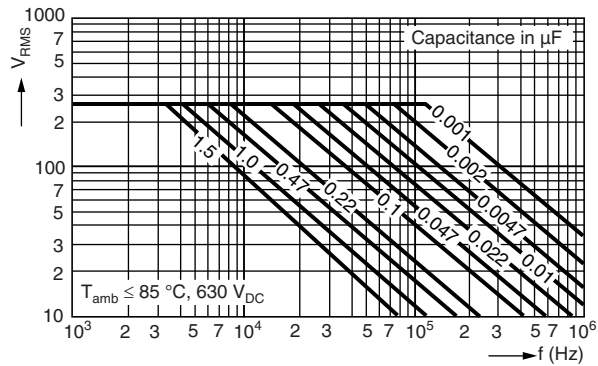
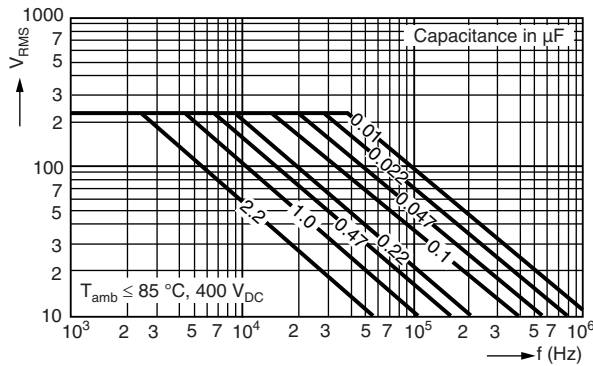
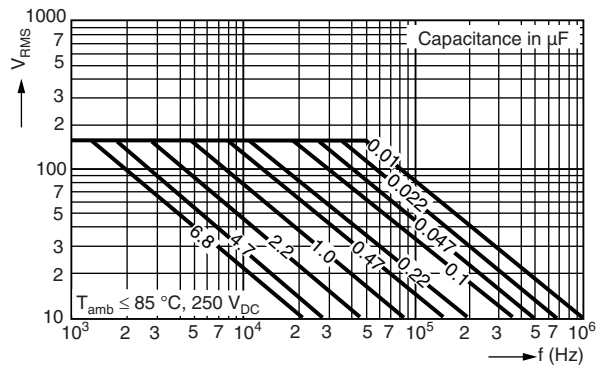
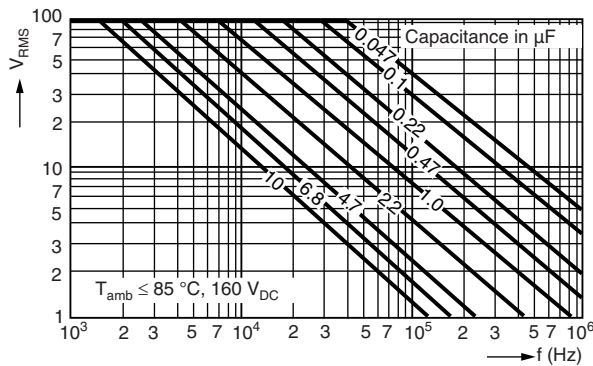

Maximum allowed component temperature rise (ΔT) as a function of the ambient temperature (T_{amb})



HEAT CONDUCTIVITY (G) AS A FUNCTION OF ORIGINAL PITCH AND CAPACITOR BODY THICKNESS IN mW/°C						
DIAMETER (mm)	HEAT CONDUCTIVITY (mW/°C)					
	L = 11 mm	L = 14 mm	L = 19 mm	L = 26.5 mm	L = 31.5 mm	L = 41.5 mm
5.0	2	3	4	5	6	8
5.5	3	3	4	6	7	9
6.0	3	4	5	7	8	10
6.5	3	4	5	7	9	11
7.0	4	5	6	8	9	12
7.5	4	5	7	9	10	13
8.0	4	5	7	10	11	15
8.5	5	6	8	10	12	16
9.0	5	6	8	11	13	17
9.5	6	7	9	12	14	18
10.0	6	7	10	13	15	19
10.5	7	8	10	14	16	20
11.0	7	8	11	14	17	21
11.5	8	9	12	15	18	23
12.0	8	10	12	16	19	24
12.5	9	10	13	17	20	25
13.0	9	11	14	18	21	26
13.5	10	11	14	19	22	28
14.0	10	12	15	20	23	29
14.5	11	13	16	21	24	30
15.0	11	13	16	21	25	31
15.5	12	14	17	22	26	33
16.0	12	14	18	23	27	34
16.5	13	15	19	24	28	35
17.0	14	16	20	25	29	37
17.5	14	17	20	26	30	38
18.0	15	17	21	27	31	39
18.5	15	18	22	28	32	41
19.0	16	19	23	29	34	42
19.5	17	19	24	30	35	43
20.0	17	20	25	31	36	45
20.5	18	21	25	32	37	46
21.0	19	22	26	33	38	48
21.5	20	22	27	35	39	49
22.0	20	23	28	36	41	50
22.5	21	24	29	37	42	52
23.0	22	25	30	38	43	53
23.5	23	26	31	39	44	55
24.0	23	27	32	40	46	56
24.5	24	27	33	41	47	58
25.0	25	28	34	42	48	59
25.5	26	29	35	44	49	61
26.0	27	30	36	45	51	62
26.5	27	31	37	46	52	64
27.0	28	32	38	47	53	66
27.5	29	33	39	48	55	67
28.0	30	34	40	50	56	69
28.5	31	35	41	51	57	70

POWER DISSIPATION AND MAXIMUM COMPONENT TEMPERATURE RISE

The power dissipation must be limited in order not to exceed the maximum allowed component temperature rise as a function of the free air ambient temperature.

The power dissipation can be calculated according type detail specification “HQN-384-01/101: Technical Information Film Capacitors with the typical tgδ of the curves”.

The component temperature rise (ΔT) can be measured (see section “Measuring the component temperature” for more details) or calculated by ΔT = P/G:

- ΔT = Component temperature rise (°C)
- P = Power dissipation of the component (mW)
- G = Heat conductivity of the component (mW/°C)

MEASURING THE COMPONENT TEMPERATURE

A thermocouple must be attached to the capacitor body as in:

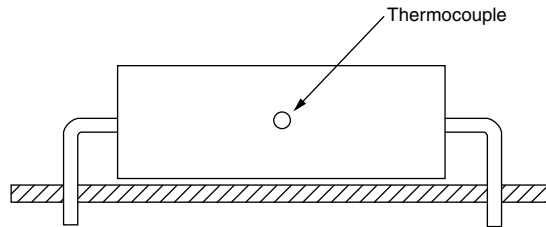

The temperature is measured in unloaded (T_{amb}) and maximum loaded condition (T_C).

The temperature rise is given by ΔT = T_C - T_{amb}.

To avoid radiation or convection, the capacitor should be tested in a wind-free box.

APPLICATION NOTE AND LIMITING CONDITIONS

These capacitors are not suitable for mains applications as across-the-line capacitors without additional protection, as described hereunder. These mains applications are strictly regulated in safety standards and therefore electromagnetic interference suppression capacitors conforming the standards must be used.

To select the capacitor for a certain application, the following conditions must be checked:

1. The peak voltage (U_P) shall not be greater than the rated DC voltage (U_{RDC})
2. The peak-to-peak voltage (U_{P-P}) shall not be greater than the maximum (U_{P-P}) to avoid the ionization inception level
3. The voltage peak slope (dU/dt) shall not exceed the rated voltage pulse slope in an RC-circuit at rated voltage and without ringing. If the pulse voltage is lower than the rated DC voltage, the rated voltage pulse slope may be multiplied by U_{RDC} and divided by the applied voltage.

For all other pulses following equation must be fulfilled:

$$2 \times \int_0^T \left(\frac{dU}{dt}\right)^2 \times dt < U_{RDC} \times \left(\frac{dU}{dt}\right)_{rated}$$

T is the pulse duration.

4. The maximum component surface temperature rise must be lower than the limits (see graph “Max. allowed component temperature rise”).
5. Since in circuits used at voltages over 280 V peak-to-peak the risk for an intrinsically active flammability after a capacitor breakdown (short circuit) increases, it is recommended that the power to the component is limited to 100 times the values mentioned in the table: “Heat conductivity”
6. When using these capacitors as across-the-line capacitor in the input filter for mains applications or as series connected with an impedance to the mains the applicant must guarantee that the following conditions are fulfilled in any case (spikes and surge voltages from the mains included).

VOLTAGE CONDITIONS FOR 6 ABOVE		
ALLOWED VOLTAGES	T_{amb} ≤ 85 °C	85 °C < T_{amb} ≤ 100 °C
Maximum continuous RMS voltage	U _{RAC}	U _{RAC}
Maximum temperature RMS-overvoltage (< 24 h)	1.25 x U _{RAC}	1.25 x U _{RAC}
Maximum peak voltage (V _{O-P}) (< 2 s)	1.6 x U _{RDC}	1.1 x U _{RDC}



INSPECTION REQUIREMENTS

General Notes

Sub-clause numbers of tests and performance requirements refer to the “Sectional Specification, Publication IEC 60384-16 and Specific Reference Data”.

GROUP C INSPECTION REQUIREMENTS		
SUB-CLAUSE NUMBER AND TEST	CONDITIONS	PERFORMANCE REQUIREMENTS
SUB-GROUP C1A PART OF SAMPLE OF SUB-GROUP C1		
4.1 Dimensions (detail)		As specified in chapter “General Data” of this specification
4.3.1 Initial measurements	Capacitance Tangent of loss angle at 100 kHz	
4.3 Robustness of terminations	Tensile and bending	No visible damage
4.4 Resistance to soldering heat	Method: 1A Solder bath: 280 °C ± 5 °C Duration: 5 s	
4.14 Component solvent resistance	Isopropylalcohol at room temperature Method: 2 Immersion time: 5 min ± 0.5 min Recovery time: Min. 1 h, max. 2 h	
4.4.2 Final measurements	Visual examination	No visible damage Legible marking
	Capacitance	$ \Delta C/C \leq 2\%$ of the value measured initially
	Tangent of loss angle	Increase of $\tan \delta \leq 0.002$ Compared to values measured in 4.3.1
SUB-GROUP C1B OTHER PART OF SAMPLE OF SUB-GROUP C1		
4.6.1 Initial measurements	Capacitance Tangent of loss angle: For $C \leq 1 \mu\text{F}$ at 10 kHz For $C > 1 \mu\text{F}$ at 1 kHz	
4.15 Solvent resistance of the marking	Isopropylalcohol at room temperature Method: 1 Rubbing material: Cotton wool Immersion time: 5 min ± 0.5 min	No visible damage Legible marking
4.6 Rapid change of temperature	θA = Lower category temperature θB = Upper category temperature 5 cycles Duration $t = 30$ min	
4.7 Vibration	Visual examination Mounting: See section “Mounting” for more information Procedure B4 Frequency range: 10 Hz to 55 Hz Amplitude: 0.75 mm or Acceleration 98 m/s ² (whichever is less severe) Total duration 6 h	No visible damage
4.7.2 Final inspection	Visual examination	No visible damage



GROUP C INSPECTION REQUIREMENTS		
SUB-CLAUSE NUMBER AND TEST	CONDITIONS	PERFORMANCE REQUIREMENTS
SUB-GROUP C1B OTHER PART OF SAMPLE OF SUB-GROUP C1		
4.9 Shock	Mounting: See section "Mounting" for more information Pulse shape: Half sine Acceleration: 490 m/s ² Duration of pulse: 11 ms	
4.9.3 Final measurements	Visual examination Capacitance Tangent of loss angle Insulation resistance	No visible damage $ \Delta C/C \leq 2\%$ of the value measured in 4.6.1 Increase of $\tan \delta \leq 0.002$ Compared to values measured in 4.6.1 As specified in section "Insulation Resistance" of this specification
SUB-GROUP C1 COMBINED SAMPLE OF SPECIMENS OF SUB-GROUPS C1A AND C1B		
4.10 Climatic sequence		
4.10.2 Dry heat	Temperature: Upper category temperature Duration: 16 h	
4.10.3 Damp heat cyclic Test Db, first cycle		
4.10.4 Cold	Temperature: Lower category temperature Duration: 2 h	
4.10.6 Damp heat cyclic Test Db, remaining cycles	Visual examination	No visible damage Legible marking
4.10.6.2 Final measurements	Capacitance Tangent of loss angle Insulation resistance	$ \Delta C/C \leq 3\%$ of the value measured in 4.4.2 or 4.9.3 Increase of $\tan \delta \leq 0.003$ Compared to values measured in 4.3.1 or 4.6.1 $\geq 50\%$ of values specified in section "Insulation Resistance" of this specification
SUB-GROUP C2		
4.11 Damp heat steady state	Capacitance	
4.11.1 Initial measurements	Tangent of loss angle at 1 kHz	
4.11.3 Final measurements	Visual examination Capacitance Tangent of loss angle Insulation resistance	No visible damage Legible marking $ \Delta C/C \leq 3\%$ of the value measured in 4.11.1. Increase of $\tan \delta \leq 0.001$ Compared to values measured in 4.11.1 $\geq 50\%$ of values specified in section "Insulation Resistance" of this specification



GROUP C INSPECTION REQUIREMENTS		
SUB-CLAUSE NUMBER AND TEST	CONDITIONS	PERFORMANCE REQUIREMENTS
SUB-GROUP C3		
4.12 Endurance DC	Duration: 2000 h 1.25 x U _{RDC} at 85 °C 0.875 x U _{RDC} at 100 °C	
4.12.1 Initial measurements	Capacitance Tangent of loss angle: For C ≤ 1 µF at 10 kHz For C > 1 µF at 1 kHz	
4.12.5 Final measurements	Visual examination	No visible damage Legible marking
	Capacitance	ΔC/C ≤ 3 % compared to values measured in 4.12.1
	Tangent of loss angle	Increase of tan δ ≤ 0.002 Compared to values measured in 4.12.1
	Insulation resistance	≥ 50 % of values specified in section "Insulation Resistance" of this specification
SUB-GROUP C4		
4.2.6 Temperature characteristics Initial measurement Intermediate Intermediate measurements	Capacitance Capacitance at lower category temperature Capacitance at 20 °C Capacitance at upper category temperature	For - 55 °C to + 20 °C: 0 % ≤ ΔC/C ≤ 2 % or for 20 °C to 85 °C: - 3 % ≤ ΔC/C ≤ 0 %
Final measurements	Capacitance Tangent of loss angle: For C ≤ 1 µF at 10 kHz For C > 1 µF at 1 kHz	As specified in section "Capacitance" of this specification
	Insulation resistance	As specified in section "Insulation Resistance" of this specification
4.13 Charge and discharge	10 000 cycles Charged to U _{RDC} Discharge resistance: $R = \frac{U_{RDC}}{2.5 \times C(dU/dt)}$	
4.13.1 Initial measurements	Capacitance Tangent of loss angle at 100 kHz	
4.13.3 Final measurements	Capacitance	ΔC/C ≤ 3 % of the value measured in 4.13.1
	Tangent of loss angle	Increase of tan δ ≤ 0.003 Compared to values measured in 4.13.1
	Insulation resistance	≥ 50 % of values specified in section "Insulation Resistance" of this specification



Disclaimer

ALL PRODUCT, PRODUCT SPECIFICATIONS AND DATA ARE SUBJECT TO CHANGE WITHOUT NOTICE TO IMPROVE RELIABILITY, FUNCTION OR DESIGN OR OTHERWISE.

Vishay Intertechnology, Inc., its affiliates, agents, and employees, and all persons acting on its or their behalf (collectively, "Vishay"), disclaim any and all liability for any errors, inaccuracies or incompleteness contained in any datasheet or in any other disclosure relating to any product.

Vishay makes no warranty, representation or guarantee regarding the suitability of the products for any particular purpose or the continuing production of any product. To the maximum extent permitted by applicable law, Vishay disclaims (i) any and all liability arising out of the application or use of any product, (ii) any and all liability, including without limitation special, consequential or incidental damages, and (iii) any and all implied warranties, including warranties of fitness for particular purpose, non-infringement and merchantability.

Statements regarding the suitability of products for certain types of applications are based on Vishay's knowledge of typical requirements that are often placed on Vishay products in generic applications. Such statements are not binding statements about the suitability of products for a particular application. It is the customer's responsibility to validate that a particular product with the properties described in the product specification is suitable for use in a particular application. Parameters provided in datasheets and / or specifications may vary in different applications and performance may vary over time. All operating parameters, including typical parameters, must be validated for each customer application by the customer's technical experts. Product specifications do not expand or otherwise modify Vishay's terms and conditions of purchase, including but not limited to the warranty expressed therein.

Hyperlinks included in this datasheet may direct users to third-party websites. These links are provided as a convenience and for informational purposes only. Inclusion of these hyperlinks does not constitute an endorsement or an approval by Vishay of any of the products, services or opinions of the corporation, organization or individual associated with the third-party website. Vishay disclaims any and all liability and bears no responsibility for the accuracy, legality or content of the third-party website or for that of subsequent links.

Vishay products are not designed for use in life-saving or life-sustaining applications or any application in which the failure of the Vishay product could result in personal injury or death unless specifically qualified in writing by Vishay. Customers using or selling Vishay products not expressly indicated for use in such applications do so at their own risk. Please contact authorized Vishay personnel to obtain written terms and conditions regarding products designed for such applications.

No license, express or implied, by estoppel or otherwise, to any intellectual property rights is granted by this document or by any conduct of Vishay. Product names and markings noted herein may be trademarks of their respective owners.