

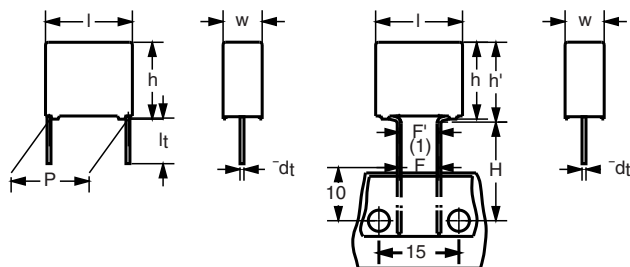

# AC and Pulse Double Metallized Polypropylene Film Capacitors MMKP Radial Potted Type



Dimensions in mm  
(1)  $|F - F'| < 0.3 \text{ mm}$   
 $F = 7.5 + 0.6/-0.1 \text{ mm}$

## FEATURES

7.5 mm bent back pitch. 15 mm to 27.5 mm lead pitch. Low contact resistance. Low loss dielectric. Small dimensions for high density packaging. Supplied loose in box and taped on reel

Material categorization: For definitions of compliance please see [www.vishay.com/doc?99912](http://www.vishay.com/doc?99912)



**RoHS**  
COMPLIANT

## ENCAPSULATION

Plastic case, epoxy resin sealed, flame retardant UL-class 94 V-0

## CLIMATIC CATEGORY

55/105/56

## CAPACITANCE RANGE (E24 SERIES)

0.001  $\mu\text{F}$  to 2.7  $\mu\text{F}$

## CAPACITANCE TOLERANCE

$\pm 5 \%$

## LEADS

Tinned wire

## RATED (DC) TEMPERATURE

85 °C

## RATED (AC) TEMPERATURE

105 °C

## MAXIMUM APPLICATION TEMPERATURE

105 °C

## DETAIL SPECIFICATION

For more detailed data and test requirements contact: [dc-film@vishay.com](mailto:dc-film@vishay.com)

## APPLICATIONS

Where steep pulses occur e.g. SMPS (switch mode power supplies). Electronic lighting e.g. Ballast. Motor control circuits. S-correction. For flyback applications please use 1400 V series.

## REFERENCE SPECIFICATIONS

IEC 60384-17

## MARKING

C-value; tolerance; rated voltage; sub-class; manufacturer's type; code for dielectric material; code for factory of origin; manufacturer; year and week of manufacture

## DIELECTRIC

Polypropylene film

## ELECTRODES

Metallized

## ENCAPSULATION

Flame retardant plastic case and epoxy resin

## CONSTRUCTION

Internal serial construction

## RATED (DC) VOLTAGE

250 V, 400 V, 630 V, 1000 V, 1400 V, 1600 V, 2000 V, 2500 V

## RATED (AC) VOLTAGE

125 V, 200 V, 220 V, 350 V, 500 V, 550 V, 700 V, 900 V

## RATED PEAK-TO-PEAK VOLTAGE

350 V, 560 V, 630 V, 1000 V, 1400 V, 1600 V, 2000 V, 2500 V



AC and Pulse Double Metallized Polypropylene Film Capacitors MMKP Radial Potted Type

Vishay BCcomponents

**COMPOSITION OF CATALOG NUMBER**

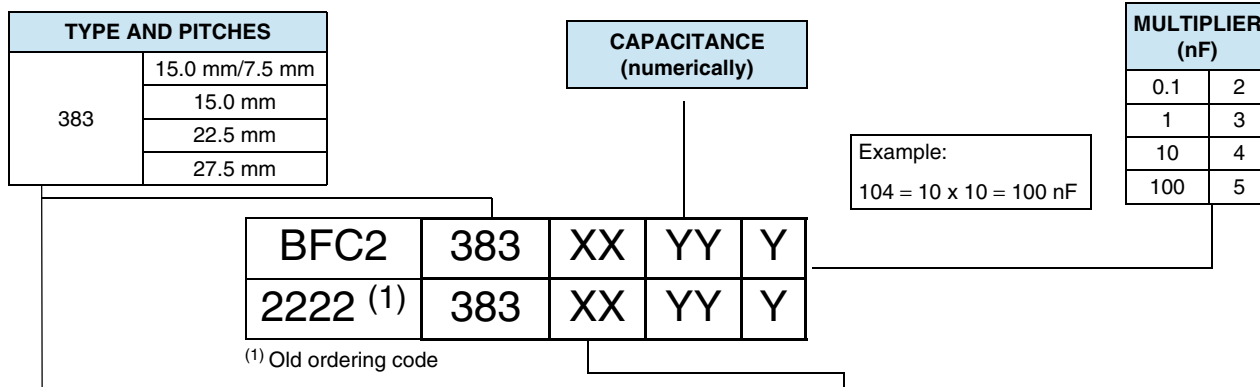

TYPE	PACKAGING	LEAD CONFIGURATION	PREFERRED TYPES								
			C-TOL.	250 V	400 V	630 V	1000 V	1400 V	1600 V	2000 V	2500 V
383	Loose in box	Lead length 3.5 mm ± 0.3 mm	± 5 %	00	10	20	30	40	50	60	70
	Taped on reel (bent back to 7.5 mm) <sup>(1)</sup>	H = 16.0 mm; P <sub>0</sub> = 15.0 mm reel diameter = 500 mm	± 5 %	03	13	23	33	43	53	63	-
			Dimensions of this code numbers stay between brackets								
			ON REQUEST								
383	Loose in box	Lead length 5.0 mm ± 1.0 mm	± 5 %	01	11	21	31	41	51	61	71
		Lead length 25.0 mm ± 2.0 mm	± 5 %	04	14	24	34	44	54	64	74
	Taped on reel <sup>(1)</sup>	H = 18.5 mm; P <sub>0</sub> = 12.7 mm	± 5 %	02	12	22	32	42	52	62	72
	Taped on reel (bent back to 7.5 mm) <sup>(1)</sup>	H = 16.0 mm; P <sub>0</sub> = 15.0 mm reel diameter = 356 mm	± 5 %	05	15	25	35	45	55	65	-
			Dimensions of this code numbers stay between brackets								
Taped on reel (bent back to 10.0 mm) <sup>(1)</sup>	H = 16.0 mm; P <sub>0</sub> = 15.0 mm reel diameter = 500 mm	± 5 %	08	18	28	38	48	58	68	-	

**Note**

<sup>(1)</sup> For detailed tape specifications refer to "Packaging Information" [www.vishay.com/doc?28139](http://www.vishay.com/doc?28139) or end of catalog

**SPECIFIC REFERENCE DATA (250 Vdc)**

DESCRIPTION	VALUE	
	at 10 kHz	at 100 kHz
Tangent of loss angle: C ≤ 0.15 μF	≤ 5 x 10 <sup>-4</sup>	≤ 20 x 10 <sup>-4</sup>
0.15 μF < C ≤ 0.39 μF	≤ 5 x 10 <sup>-4</sup>	≤ 25 x 10 <sup>-4</sup>
0.39 μF < C ≤ 0.56 μF	≤ 10 x 10 <sup>-4</sup>	≤ 25 x 10 <sup>-4</sup>
0.56 μF < C ≤ 0.82 μF	≤ 10 x 10 <sup>-4</sup>	≤ 40 x 10 <sup>-4</sup>
0.82 μF < C ≤ 1.2 μF	≤ 10 x 10 <sup>-4</sup>	≤ 50 x 10 <sup>-4</sup>
1.2 μF < C ≤ 1.8 μF	≤ 10 x 10 <sup>-4</sup>	≤ 65 x 10 <sup>-4</sup>
1.8 μF < C ≤ 2.2 μF	≤ 15 x 10 <sup>-4</sup>	≤ 75 x 10 <sup>-4</sup>
2.2 μF < C ≤ 2.7 μF	≤ 15 x 10 <sup>-4</sup>	≤ 85 x 10 <sup>-4</sup>
Rated voltage pulse slope (dU/d <sub>i</sub> )R: C ≤ 0.15 μF	450 V/μs	
0.15 μF < C ≤ 0.39 μF	900 V/μs	
0.39 μF < C ≤ 0.82 μF	290 V/μs	
0.82 μF < C ≤ 2 μF	190 V/μs	
2 μF < C ≤ 2.7 μF	130 V/μs	
R between leads, for C ≤ 1 μF at 100 V, 1 min	> 100 000 MΩ	
RC between leads, for C > 1 μF at 100 V, 1 min	> 100 000 s	
R between leads and case, 100 V, 1 min	> 30 000 MΩ	
Ionization (AC) voltage (typical value) at 50 pC peak discharge	> 220 V	
Withstanding (DC) voltage (cut off current 10 mA), rise time 100 V/s	400 V, 1 min	
Withstanding (DC) voltage between leads and case	2840 V, 1 min	
Maximum application temperature	105 °C	



AC and Pulse Double Metallized Polypropylene  
Film Capacitors MMKP Radial Potted Type

Vishay BCcomponents

$U_{Rdc} = 250\text{ V}$ ;  $U_{Rac} = 125\text{ V}$ ;  $U_{pp} = 350\text{ V}$ ;  $C\text{-tol.} = \pm 5\%$

C ( $\mu\text{F}$ )	DIMENSIONS w x h (h') x l (mm)	MASS (g) <sup>(1)</sup>	CATALOG NUMBER BFC2 383 XXYYY AND PACKAGING					C-VALUE  ..YYY
			LOOSE IN BOX		Original pitch	REEL		
			Leads 3.5 $\pm$ 0.3 mm	Leads 25.0 $\pm$ 2.0 mm		Pitch = 7.5 mm (bent back)		
			XX (SPQ)	XX (SPQ)	XX (SPQ)	XX (SPQ)	XX (SPQ)	
Pitch = 15 mm $\pm$ 0.4 mm; $d_t = 0.80\text{ mm} \pm 0.08\text{ mm}$					Pitch = 15 mm	Pitch = 7.5 mm (bent back)		
0.082 0.091 0.1	5.0 x 11.0 (13.0) x 17.5	1.1	00... (1250)	04... (1000)	02... (1100)	03... (950)	05... (550)	823 913 104
0.11 0.12 0.13 0.15	6.0 x 12.0 (14.0) x 17.5	1.4	00... (1000)	04... (1000)	02... (900)	03... (800)	05... (450)	114 124 134 154
0.16 0.18 0.2	7.0 x 13.5 (15.5) x 17.5	1.8	00... (750)	04... (500)	02... (800)	03... (700)	05... (400)	164 184 204
0.22 0.24 0.27 0.3	8.5 x 15.0 (17.0) x 17.5	2.6	00... (750)	04... (500)	02... (650)	03... (550)	05... (300)	224 244 274 304
0.33 0.36 0.39	10.0 x 16.5 (18.5) x 17.5	3.3	00... (500)	04... (450)	02... (600)	03... (500)	05... (250)	334 364 394

**Notes**

- <sup>(1)</sup> Net weight for short lead products only
- SPQ = Standard Packaging Quantity

$U_{Rdc} = 250\text{ V}$ ;  $U_{Rac} = 125\text{ V}$ ;  $U_{pp} = 350\text{ V}$ ;  $C\text{-tol.} = \pm 5\%$

C ( $\mu\text{F}$ )	DIMENSIONS w x h x l (mm)	MASS (g) <sup>(1)</sup>	CATALOG NUMBER BFC2 383 XXYYY AND PACKAGING				C-VALUE  ..YYY
			LOOSE IN BOX		Original pitch	REEL	
			Leads 3.5 $\pm$ 0.3 mm	Leads 25.0 $\pm$ 2.0 mm			
			XX (SPQ)	XX (SPQ)	XX (SPQ)		
Pitch = 22.5 mm $\pm$ 0.4 mm; $d_t = 0.80\text{ mm} \pm 0.08\text{ mm}$					Pitch = 22.5 mm		
0.43	7.0 x 116.5 x 26.0	3.0	00... (200)	04... (250)	02... (550)	434	
0.47 0.51 0.56 0.62	8.5 x 18.0 x 26.0	4.2	00... (200)	04... (250)	02... (450)	474 514 564 624	
0.68 0.75 0.82	10.0 x 19.5 x 26.0	5.3	00... (200)	04... (200)	02... (350)	684 754 824	
Pitch = 27.5 mm $\pm$ 0.4 mm; $d_t = 0.80\text{ mm} \pm 0.08\text{ mm}$					Pitch = 27.5 mm		
0.91 1.0 1.1 1.2	11.0 x 21.0 x 31.0	8.0	00... (750)	04... (125)	-	914 105 115 125	
1.3 1.5 1.6	13.0 x 23.0 x 31.0	9.7	00... (500)	04... (125)		135 155 165	
1.8 2.0	15.0 x 25.0 x 31.0	12.6	00... (100)	04... (125)		185 205	
2.2 2.4 2.7	18.0 x 28.0 x 31.0	16.3	00... (100)	04... (100)		225 245 275	

**Notes**

- <sup>(1)</sup> Net weight for short lead products only
- SPQ = Standard Packaging Quantity



AC and Pulse Double Metallized Polypropylene  
Film Capacitors MMKP Radial Potted Type

Vishay BCcomponents

**SPECIFIC REFERENCE DATA (400 Vdc)**

DESCRIPTION	VALUE	
	at 10 kHz	at 100 kHz
Tangent of loss angle:		
$C \leq 0.22 \mu\text{F}$	$\leq 5 \times 10^{-4}$	$\leq 20 \times 10^{-4}$
$0.22 \mu\text{F} < C \leq 0.33 \mu\text{F}$	$\leq 10 \times 10^{-4}$	$\leq 35 \times 10^{-4}$
$0.33 \mu\text{F} < C \leq 0.43 \mu\text{F}$	$\leq 10 \times 10^{-4}$	$\leq 40 \times 10^{-4}$
$0.43 \mu\text{F} < C \leq 0.68 \mu\text{F}$	$\leq 10 \times 10^{-4}$	$\leq 50 \times 10^{-4}$
$0.68 \mu\text{F} < C \leq 0.82 \mu\text{F}$	$\leq 10 \times 10^{-4}$	$\leq 55 \times 10^{-4}$
$0.82 \mu\text{F} < C \leq 1.2 \mu\text{F}$	$\leq 10 \times 10^{-4}$	$\leq 60 \times 10^{-4}$
$1.2 \mu\text{F} < C \leq 1.5 \mu\text{F}$	$\leq 10 \times 10^{-4}$	$\leq 65 \times 10^{-4}$
Rated voltage pulse slope (dU/dt) <sub>R</sub> :		
$C \leq 0.082 \mu\text{F}$	600 V/μs	
$0.082 \mu\text{F} < C \leq 0.22 \mu\text{F}$	1200 V/μs	
$0.22 \mu\text{F} < C \leq 0.43 \mu\text{F}$	410 V/μs	
$0.42 \mu\text{F} < C \leq 1.1 \mu\text{F}$	260 V/μs	
$1.1 \mu\text{F} < C \leq 1.5 \mu\text{F}$	180 V/μs	
R between leads, for $C \leq 1 \mu\text{F}$ at 100 V, 1 min	> 100 000 MΩ	
RC between leads, for $C > 1 \mu\text{F}$ at 100 V, 1 min	> 100 000 s	
R between leads and case, 100 V, 1 min	> 30 000 MΩ	
Ionization (AC) voltage (typical value) at 50 pC peak discharge	> 220 V	
Withstanding (DC) voltage (cut off current 10 mA), rise time 100 V/s	560 V, 1 min	
Withstanding (DC) voltage between leads and case	2840 V, 1 min	
Maximum application temperature	105 °C	

$U_{Rdc} = 400 \text{ V}$ ;  $U_{Rac} = 200 \text{ V}$ ;  $U_{pp} = 560 \text{ V}$ ; C-tol. =  $\pm 5 \%$

C (μF)	DIMENSIONS w x h (h') x l (mm)	MASS (g) <sup>(1)</sup>	CATALOG NUMBER BFC2 383 XXYYY AND PACKAGING					C-VALUE  ..YYY
			LOOSE IN BOX		Original pitch	REEL		
			Leads 3.5 ± 0.3 mm	Leads 25.0 ± 2.0 mm		Pitch = 7.5 mm (bent back)		
			XX (SPQ)	XX (SPQ)	XX (SPQ)	XX (SPQ)	XX (SPQ)	
<b>Pitch = 15 mm ± 0.4 mm; d<sub>t</sub> = 0.80 mm ± 0.08 mm</b>					<b>Pitch = 15 mm</b>	<b>Pitch = 7.5 mm (bent back)</b>		
0.047	5.0 x 11.0 (13.0) x 17.5	1.1	<b>10...</b>	<b>14...</b>	<b>12...</b>	<b>13...</b>	<b>15...</b>	<b>473</b>
0.051			(1250)	(1000)	(1100)	(950)	(550)	<b>513</b>
0.056								<b>563</b>
0.062	6.0 x 12.0 (14.0) x 17.5	1.4	<b>10...</b>	<b>14...</b>	<b>12...</b>	<b>13...</b>	<b>15...</b>	<b>623</b>
0.068			(1000)	(1000)	(900)	(800)	(450)	<b>683</b>
0.075								<b>753</b>
0.082								<b>823</b>
0.091	7.0 x 13.5 (15.5) x 17.5	1.8	<b>10...</b>	<b>14...</b>	<b>12...</b>	<b>13...</b>	<b>15...</b>	<b>913</b>
0.1			(750)	(500)	(800)	(700)	(400)	<b>104</b>
0.11								<b>114</b>
0.12	8.5 x 15.0 (17.0) x 17.5	2.5	<b>10...</b>	<b>14...</b>	<b>12...</b>	<b>13...</b>	<b>15...</b>	<b>124</b>
0.13			(750)	(500)	(650)	(550)	(300)	<b>134</b>
0.15								<b>154</b>
0.16								<b>164</b>
0.18	10.0 x 16.5 (18.5) x 17.5	3.3	<b>10...</b>	<b>14...</b>	<b>12...</b>	<b>13...</b>	<b>15...</b>	<b>184</b>
0.2			(500)	(450)	(600)	(500)	(250)	<b>204</b>
0.22								<b>224</b>

**Notes**

- <sup>(1)</sup> Net weight for short lead products only
- SPQ = Standard Packaging Quantity



AC and Pulse Double Metallized Polypropylene  
Film Capacitors MMKP Radial Potted Type

Vishay BCcomponents

$U_{Rdc} = 400\text{ V}$ ;  $U_{Rac} = 200$ ;  $U_{p-p} = 560\text{ V}$ ; C-tol. =  $\pm 5\%$

C ( $\mu\text{F}$ )	DIMENSIONS w x h x l (mm)	MASS (g) <sup>(1)</sup>	CATALOG NUMBER BFC2 383 XXYYY AND PACKAGING			
			LOOSE IN BOX		REEL	C-VALUE
			Leads 3.5 $\pm$ 0.3 mm	Leads 25.0 $\pm$ 2.0 mm	Original pitch	..YYY
			XX (SPQ)	XX (SPQ)	XX (SPQ)	
<b>Pitch = 22.5 mm <math>\pm</math> 0.4 mm; <math>d_t = 0.80\text{ mm} \pm 0.08\text{ mm}</math></b>			<b>Pitch = 22.5 mm</b>			
0.24	7.0 x 116.5 x 26.0	3.0	10... (200)	14... (250)	12... (550)	244
0.27	8.5 x 18.0 x 26.0	4.2	10... (200)	14... (250)	12... (450)	274
0.30						304
0.33						334
0.36	10.0 x 19.5 x 26.0	5.3	10... (200)	14... (200)	12... (350)	364
0.39						394
0.43						434
<b>Pitch = 27.5 mm <math>\pm</math> 0.4 mm; <math>d_t = 0.80\text{ mm} \pm 0.08\text{ mm}</math></b>			<b>Pitch = 27.5 mm</b>			
0.47	11.0 x 21.0 x 31.0	8.0	10... (100)	14... (125)	-	474
0.51						514
0.56						564
0.62						624
0.68	13.0 x 23.0 x 31.0	9.7	10... (100)	14... (125)	-	684
0.75						754
0.82						824
0.91	15.0 x 25.0 x 31.0	12.6	10... (100)	14... (125)	-	914
1.						105
1.1						115
1.2	18.0 x 28.0 x 31.0	16.3	10... (100)	14... (100)	-	125
1.3						135
1.5						155

**Notes**

- (1) Net weight for short lead products only
- SPQ = Standard Packaging Quantity

**SPECIFIC REFERENCE DATA (630 Vdc)**

DESCRIPTION	VALUE	
Tangent of loss angle: C $\leq$ 0.15 $\mu\text{F}$ 0.15 $\mu\text{F}$ < C $\leq$ 0.22 $\mu\text{F}$ 0.22 $\mu\text{F}$ < C $\leq$ 0.3 $\mu\text{F}$ 0.3 $\mu\text{F}$ < C $\leq$ 0.47 $\mu\text{F}$ 0.47 $\mu\text{F}$ < C $\leq$ 0.68 $\mu\text{F}$ 0.68 $\mu\text{F}$ < C $\leq$ 1.0 $\mu\text{F}$	at 10 kHz	at 100 kHz
	$\leq 5 \times 10^{-4}$	$\leq 15 \times 10^{-4}$
	$\leq 8 \times 10^{-4}$	$\leq 25 \times 10^{-4}$
	$\leq 8 \times 10^{-4}$	$\leq 30 \times 10^{-4}$
	$\leq 10 \times 10^{-4}$	$\leq 40 \times 10^{-4}$
	$\leq 10 \times 10^{-4}$	$\leq 45 \times 10^{-4}$
	$\leq 10 \times 10^{-4}$	$\leq 50 \times 10^{-4}$
Rated voltage pulse slope (dU/dt) <sub>R</sub> : C $\leq$ 0.056 $\mu\text{F}$ 0.056 $\mu\text{F}$ < C $\leq$ 0.15 $\mu\text{F}$ 0.15 $\mu\text{F}$ < C $\leq$ 0.3 $\mu\text{F}$ 0.3 $\mu\text{F}$ < C $\leq$ 0.75 $\mu\text{F}$ 0.75 $\mu\text{F}$ < C $\leq$ 1.0 $\mu\text{F}$	700 V/ $\mu\text{s}$	
	1400 V/ $\mu\text{s}$	
	470 V/ $\mu\text{s}$	
	300 V/ $\mu\text{s}$	
	210 V/ $\mu\text{s}$	
R between leads, for C $\leq$ 1 $\mu\text{F}$ at 100 V, 1 min	> 100 000 M $\Omega$	
R between leads and case, 100 V, 1 min	> 30 000 M $\Omega$	
Ionization (AC) voltage (typical value) at 50 pC peak discharge	> 250 V	
Withstanding (DC) voltage (cut off current 10 mA), rise time 100 V/s	1000 V, 1 min	
Withstanding (DC) voltage between leads and case	2840 V, 1 min	
Maximum application temperature	105 °C	



AC and Pulse Double Metallized Polypropylene  
Film Capacitors MMKP Radial Potted Type

Vishay BCcomponents

$U_{Rdc} = 630\text{ V}$ ;  $U_{Rac} = 220\text{ V}$ ;  $U_{p-p} = 630\text{ V}$ ; C-tol. =  $\pm 5\%$

C ( $\mu\text{F}$ )	DIMENSIONS w x h (h') x l (mm)	MASS (g) <sup>(1)</sup>	CATALOG NUMBER BFC2 383 XYYYY AND PACKAGING					C-VALUE  ..YYY
			LOOSE IN BOX		Original pitch	REEL		
			Leads 3.5 $\pm$ 0.3 mm	Leads 25.0 $\pm$ 2.0 mm		Pitch = 7.5 mm (bent back)		
			XX (SPQ)	XX (SPQ)	XX (SPQ)	XX (SPQ)	XX (SPQ)	
<b>Pitch = 15 mm <math>\pm</math> 0.4 mm; d<sub>t</sub> = 0.80 mm <math>\pm</math> 0.08 mm</b>					<b>Pitch = 15 mm</b>	<b>Pitch = 7.5 mm (bent back)</b>		
0.03 0.033 0.036	5.0 x 11.0 (13.0) x 17.5	1.1	20... (1250)	24... (1000)	22... (2200)	23... (950)	25... (550)	303 333 363
0.039 0.043 0.047 0.051 0.056	6.0 x 12.0 (14.0) x 17.5	1.4	20... (1000)	24... (1000)	22... (900)	23... (800)	25... (450)	393 433 473 513 563
0.062 0.068 0.075	7.0 x 13.5 (15.5) x 17.5	1.8	20... (750)	24... (500)	22... (800)	23... (700)	25... (400)	623 683 753
0.082 0.091 0.1 0.11	8.5 x 15.0 (17.0) x 17.5	2.5	20... (750)	24... (500)	22... (650)	23... (550)	25... (300)	823 913 104 114
0.12 0.13 0.15	10.0 x 16.5 (18.5) x 17.5	3.3	20... (500)	24... (450)	22... (600)	23... (500)	25... (250)	124 134 154
<b>Pitch = 22.5 mm <math>\pm</math> 0.4 mm; d<sub>t</sub> = 0.80 mm <math>\pm</math> 0.08 mm</b>					<b>Pitch = 22.5 mm</b>			
0.16 0.18 0.2 0.22	8.5 x 18.0 x 26.0	4.2	20... (200)	24... (250)	22... (450)	-	-	164 184 204 224
0.24 0.27 0.3	10.0 x 19.5 x 26.0	5.3	20... (200)	24... (200)	22... (350)	-	-	174 304
<b>Pitch = 27.5 mm <math>\pm</math> 0.4 mm; d<sub>t</sub> = 0.80 mm <math>\pm</math> 0.08 mm</b>					<b>Pitch = 27.5 mm</b>			
0.33 0.36 0.39 0.43	11.0 x 21.0 x 31.0	8.0	20... (750)	24... (125)				334 364 394 434
0.47 0.51 0.56	13.0 x 23.0 x 31.0	9.7	20... (500)	24... (125)				474 514 564
0.62 0.68 0.75	15.0 x 25.0 x 31.0	12.6	20... (100)	24... (125)				624 684 754
0.82 0.91 1.0	18.0 x 28.0 x 31.0	16.3	20... (100)	24... (100)				824 914 105

**Notes**

<sup>(1)</sup> Net weight for short lead products only

- SPQ = Standard Packaging Quantity



AC and Pulse Double Metallized Polypropylene  
Film Capacitors MMKP Radial Potted Type

Vishay BCcomponents

**SPECIFIC REFERENCE DATA (1000 Vdc)**

DESCRIPTION	VALUE	
	at 10 kHz	at 100 kHz
Tangent of loss angle: C ≤ 0.062 μF	≤ 5 x 10 <sup>-4</sup>	≤ 15 x 10 <sup>-4</sup>
0.062 μF < C ≤ 0.13 μF	≤ 6 x 10 <sup>-4</sup>	≤ 20 x 10 <sup>-4</sup>
0.13 μF < C ≤ 0.22 μF	≤ 8 x 10 <sup>-4</sup>	≤ 25 x 10 <sup>-4</sup>
0.22 μF < C ≤ 0.33 μF	≤ 8 x 10 <sup>-4</sup>	≤ 30 x 10 <sup>-4</sup>
0.33 μF < C ≤ 0.47 μF	≤ 8 x 10 <sup>-4</sup>	≤ 35 x 10 <sup>-4</sup>
Rated voltage pulse slope (dU/dt) <sub>R</sub> : C ≤ 0.024 μF	1700 V/μs	
0.024 μF < C ≤ 0.062 μF	3300 V/μs	
0.062 μF < C ≤ 0.13 μF	1200 V/μs	
0.13 μF < C ≤ 0.33 μF	700 V/μs	
0.33 μF < C ≤ 0.47 μF	470 V/μs	
R between leads, for C ≤ 1 μF at 500 V, 1 min	> 100 000 MΩ	
R between leads and case, 500 V, 1 min	> 30 000 MΩ	
Ionization (AC) voltage (typical value) at 50 pC peak discharge	> 440 V	
Withstanding (DC) voltage (cut off current 10 mA), rise time 100 V/s	1600 V, 1 min	
Withstanding (DC) voltage between leads and case	2840 V, 1 min	
Maximum application temperature	105 °C	

**U<sub>Rdc</sub> = 1000 V; U<sub>Rac</sub> = 350 V; U<sub>p-p</sub> = 1000 V; C-tol. = ± 5 %**

C (μF)	DIMENSIONS w x h (h') x l (mm)	MASS (g) <sup>(1)</sup>	CATALOG NUMBER BFC2 383 XXYYY AND PACKAGING					C-VALUE  ..YYY
			LOOSE IN BOX		Original pitch	REEL		
			Leads 3.5 ± 0.3 mm	Leads 25.0 ± 2.0 mm		Pitch = 7.5 mm (bent back)		
			XX (SPQ)	XX (SPQ)	XX (SPQ)	Ø 500 mm	Ø 356 mm	
Pitch = 15 mm ± 0.4 mm; d <sub>t</sub> = 0.80 mm ± 0.08 mm					Pitch = 15 mm	Pitch = 7.5 mm (bent back)		
0.0043	5.0 x 11.0 (13.0) x 17.5	1.1	30... (1250)	34... (1000)	32... (1100)	33... (950)	35... (550)	432
0.0047								472
0.0051								512
0.0056								562
0.0062								622
0.0068								682
0.0075								752
0.0082								822
0.0091								912
0.01								103
0.011								113
0.012								123
0.013								133
0.015	153							
0.016	163							
0.018	6.0 x 12.0 (14.0) x 17.5	1.4	30... (1000)	34... (1000)	32... (900)	33... (800)	35... (450)	183
0.02								203
0.022								223
0.024								243
0.027	7.0 x 13.5 (15.5) x 17.5	1.8	30... (750)	34... (500)	32... (800)	33... (700)	35... (400)	273
0.030								303
0.033								333
0.036	8.5 x 15.0 (17.0) x 17.5	2.5	30... (750)	34... (500)	32... (650)	33... (550)	35... (300)	363
0.039								393
0.043								433
0.047								473
0.051	10.0 x 16.5 (18.5) x 17.5	3.3	30... (500)	34... (450)	32... (600)	33... (500)	35... (250)	513
0.056								563
0.062								623

**Notes**

- <sup>(1)</sup> Net weight for short lead products only
- SPQ = Standard Packaging Quantity



AC and Pulse Double Metallized Polypropylene  
Film Capacitors MMKP Radial Potted Type

Vishay BCcomponents

C ( $\mu$ F)	DIMENSIONS w x h (h') x l (mm)	MASS (g) <sup>(1)</sup>	CATALOG NUMBER BFC2 383 XXYYY AND PACKAGING			
			LOOSE IN BOX		REEL	C-VALUE
			Leads	Leads	Original pitch	..YYY
			XX (SPQ)	XX (SPQ)	XX (SPQ)	
<b>Pitch = 22.5 mm <math>\pm</math> 0.4 mm; d<sub>t</sub> = 0.80 mm <math>\pm</math> 0.08 mm</b>			<b>Pitch 22.5 mm</b>			
0.068	7.0 x 16.5 x 26.5	3.0	30... (200)	34... (250)	32... (550)	683
0.075 0.082 0.091	8.5 x 18.0 x 26.0	4.2	30... (200)	34... (250)	32... (450)	753 823 913
0.1 0.11 0.12 0.13	10.0 x 19.5 x 26.0	5.3	30... (200)	34... (200)	32... (350)	104 114 124 134
<b>Pitch = 27.5 mm <math>\pm</math> 0.4 mm; d<sub>t</sub> = 0.80 mm <math>\pm</math> 0.08 mm</b>			<b>Pitch = 27.5 mm</b>			
0.15 0.16 0.18	11.0 x 21.0 x 31.0	8.0	30... (100)	34... (125)		154 164 184
0.2 0.22 0.24	13.0 x 23.0 x 31.0	9.7	30... (100)	34... (125)		204 224 244
0.27 0.3 0.33	15.0 x 25.0 x 31.0	12.6	30... (100)	34... (125)		274 304 334
0.36 0.39 0.43 0.47	18.0 x 28.0 x 31.0	16.3	30... (100)	34... (100)		364 394 434 474

**Notes**

<sup>(1)</sup> Net weight for short lead products only

- SPQ = Standard Packaging Quantity

**SPECIFIC REFERENCE DATA (1400 Vdc)**

DESCRIPTION	VALUE	
	at 10 kHz	at 100 kHz
Tangent of loss angle:		
C $\leq$ 0.016 $\mu$ F	$\leq 5 \times 10^{-4}$	$\leq 10 \times 10^{-4}$
0.016 $\mu$ F < C $\leq$ 0.039 $\mu$ F	$\leq 5 \times 10^{-4}$	$\leq 15 \times 10^{-4}$
0.039 $\mu$ F < C $\leq$ 0.13 $\mu$ F	$\leq 5 \times 10^{-4}$	$\leq 20 \times 10^{-4}$
Rated voltage pulse slope (dU/dt) <sub>R</sub> :		
C $\leq$ 0.0056 $\mu$ F	8000 V/ $\mu$ s	
0.0056 $\mu$ F < C $\leq$ 0.016 $\mu$ F	15 000 V/ $\mu$ s	
0.016 $\mu$ F < C $\leq$ 0.039 $\mu$ F	4000 V/ $\mu$ s	
0.039 $\mu$ F < C $\leq$ 0.1 $\mu$ F	2100 V/ $\mu$ s	
0.1 $\mu$ F < C $\leq$ 0.13 $\mu$ F	1500 V/ $\mu$ s	
R between leads, for C $\leq$ 1 $\mu$ F at 500 V, 1 min	> 100 000 M $\Omega$	
R between leads and case, 500 V, 1 min	> 30 000 M $\Omega$	
Ionization (AC) voltage (typical value) at 20 pC peak discharge	> 500 V	
Withstanding (DC) voltage (cut off current 10 mA), rise time 100 V/s	2250 V, 1 min	
Withstanding (DC) voltage between leads and case	2840 V, 1 min	
Maximum application temperature	105 °C	





AC and Pulse Double Metallized Polypropylene  
Film Capacitors MMKP Radial Potted Type

Vishey BCcomponents

$U_{Rdc} = 1400\text{ V}$ ;  $U_{Rac} = 500\text{ V}$ ;  $U_{p-p} = 1400\text{ V}$ ;  $C\text{-tol.} = \pm 5\%$

C ( $\mu\text{F}$ )	DIMENSIONS w x h (h') x l (mm)	MASS (g) <sup>(1)</sup>	CATALOG NUMBER BFC2 383 XXYYY AND PACKAGING						C-VALUE  ..YYY
			LOOSE IN BOX			REEL			
			Leads 3.5 ± 0.3 mm	Leads 25.0 ± 2.0 mm	Original pitch	Pitch = 7.5 mm (bent back)			
			XX (SPQ)	XX (SPQ)	XX (SPQ)	Ø 500 mm	Ø 356 mm		
<b>Pitch = 15 mm ± 0.4 mm; d<sub>t</sub> = 0.80 mm ± 0.08 mm</b>			<b>Pitch = 15 mm</b>			<b>Pitch = 7.5 mm (bent back)</b>			
0.0022 0.0024 0.0027 0.003 0.0033 0.0036 0.0039	5.0 x 11.0 (13.0) x 17.5	1.1	40... (1250)	44... (1000)	42... (1100)	43... (950)	45... (550)	222 242 272 302 332 362 392	
0.0043 0.0047 0.0051 0.0056	6.0 x 12.0 (14.0) x 17.5	1.4	40... (1000)	44... (1000)	42... (900)	43... (800)	45... (450)	432 472 512 562	
0.0062 0.0068 0.0075 0.0082	7.0 x 13.5 (15.5) x 17.5	1.8	40... (750)	44... (500)	42... (800)	43... (700)	45... (400)	622 682 752 822	
0.0091 0.01 0.011 0.012	8.5 x 15.0 (17.0) x 17.5	2.5	40... (750)	44... (500)	42... (650)	43... (550)	45... (300)	912 103 113 123	
0.013 0.015 0.016	10.0 x 16.5 (18.5) x 17.5	3.3	40... (500)	44... (450)	42... (600)	43... (500)	45... (250)	133 153 163	
<b>Pitch = 22.5 ± 0.4 mm; d<sub>t</sub> = 0.80 mm ± 0.08 mm</b>			<b>Pitch = 22.5 mm</b>						
0.018 0.02	7.0 x 16.5 x 26.0	3	40... (200)	44... (250)	42... (550)	-	-	183 203	
0.022 0.024 0.027	8.5 x 18.0 x 26.0	4.2	40... (200)	44... (250)	42... (450)	-	-	223 243 273	
0.03 0.033 0.036 0.039	10.0 x 19.5 x 26.0	5.3	40... (200)	44... (200)	42... (350)	-	-	303 333 363 393	
<b>Pitch = 27.5 ± 0.4 mm; d<sub>t</sub> = 0.80 mm ± 0.08 mm</b>			<b>Pitch = 27.5 mm</b>						
0.043 0.047 0.051 0.056	11.0 x 21.0 x 31.0	8	40...	44...				433 473 513 563	
0.062 0.068 0.075	13.0 x 23.0 x 31.0	9.7	40... (100)	44... (125)				623 683 753	
0.082 0.091 0.1	15.0 x 25.0 x 31.0	12.6	40... (100)	44... (125)				823 913 104	
0.11 0.12 0.13	18.0 x 28.0 x 31.0	16.3	40... (100)	44... (100)				114 124 134	

**Notes**

(1) Net weight for short lead products only

• SPQ = Standard Packaging Quantity



AC and Pulse Double Metallized Polypropylene  
Film Capacitors MMKP Radial Potted Type

Vishay BCcomponents

**SPECIFIC REFERENCE DATA (1600 Vdc)**

DESCRIPTION	VALUE	
Tangent of loss angle: $C \leq 0.015 \mu\text{F}$ $0.015 \mu\text{F} < C \leq 0.15 \mu\text{F}$	at 10 kHz	at 100 kHz
	$\leq 5 \times 10^{-4}$	$\leq 15 \times 10^{-4}$
Rated voltage pulse slope (dU/dt) <sub>R</sub> : $C \leq 0.0056 \mu\text{F}$ $0.0056 \mu\text{F} < C \leq 0.0075 \mu\text{F}$ $0.0075 \mu\text{F} < C \leq 0.039 \mu\text{F}$ $0.039 \mu\text{F} < C \leq 0.1 \mu\text{F}$ $0.1 \mu\text{F} < C \leq 0.15 \mu\text{F}$	8000 V/ $\mu\text{s}$ 15 000 V/ $\mu\text{s}$ 3100 V/ $\mu\text{s}$ 1800 V/ $\mu\text{s}$ 1200 V/ $\mu\text{s}$	
R between leads, for $C \leq 1 \mu\text{F}$ at 500 V, 1 min	> 100 000 M $\Omega$	
R between leads and case, 500 V, 1 min	> 30 000 M $\Omega$	
Ionization (AC) voltage (typical value) at 20 pC peak discharge	> 660 V	
Withstanding (DC) voltage (cut off current 10 mA), rise time 100 V/s	2560 V, 1 min	
Withstanding (DC) voltage between leads and case	2840 V, 1 min	
Maximum application temperature	105 °C	

**U<sub>Rdc</sub> = 1600 V; U<sub>Rac</sub> = 550 V; U<sub>p-p</sub> = 1600 V; C-tol. =  $\pm 5\%$**

C ( $\mu\text{F}$ )	DIMENSIONS w x h (h') x l (mm)	MASS (g) <sup>(1)</sup>	CATALOG NUMBER BFC2 383 XYYYY AND PACKAGING						C-VALUE ..YYY
			LOOSE IN BOX		Original pitch	REEL			
			Leads 3.5 $\pm$ 0.3	Leads 25.0 $\pm$ 2.0		Pitch = 7.5 mm (bent back)			
			XX (SPQ)	XX (SPQ)	XX (SPQ)	XX (SPQ)	XX (SPQ)		
<b>Pitch = 15 mm <math>\pm</math> 0.4 mm; d<sub>t</sub> = 0.80 mm <math>\pm</math> 0.08 mm</b>			<b>Pitch = 15 mm</b>			<b>Pitch = 7.5 mm (bent back)</b>			
0.0027 0.003 0.0033 0.0036 0.0039	5.0 x 11.0 (13.0) x 17.5	1.1	50... (1250)	54... (1000)	52... (1100)	53... (950)	55... (550)	272 302 332 362 392	
0.0043 0.0047 0.0051 0.0056	6.0 x 12.0 (14.0) x 17.5	1.4	50... (1000)	54... (1000)	52... (900)	53... (800)	55... (450)	432 472 512 562	
0.0062 0.0068 0.0075	7.0 x 13.5 (15.5) x 17.5	1.8	50... (750)	54... (500)	52... (800)	53... (700)	55... (400)	622 682 752	
0.0082 0.0091 0.01 0.011	8.5 x 15.0 (17.0) x 17.5	2.5	50... (750)	54... (500)	52... (650)	53... (550)	55... (300)	822 912 103 113	
0.012 0.013 0.015	10.0 x 16.5 (18.5) x 17.5	3.3	50... (500)	54... (450)	52... (600)	53... (500)	55... (250)	123 133 153	
<b>Pitch = 22.5 <math>\pm</math> 0.4 mm; d<sub>t</sub> = 0.80 mm <math>\pm</math> 0.08 mm</b>			<b>Pitch = 22.5 mm</b>						
0.016 0.018 0.02	7.0 x 16.5 x 26.0	3.0	50... (200)	54... (250)	52... (550)	-	-	163 183 203	
0.022 0.024 0.027 0.03	8.5 x 18.0 x 26.0	4.2	50... (200)	54... (250)	52... (450)	-	-	223 243 273 303	
0.033 0.036 0.039	10.0 x 19.5 x 26.0	5.3	50... (200)	54... (200)	52... (350)	-	-	333 363 393	

**Notes**

- <sup>(1)</sup> Net weight for short lead products only
- SPQ = Standard Packaging Quantity



AC and Pulse Double Metallized Polypropylene  
Film Capacitors MMKP Radial Potted Type

Vishay BCcomponents

$U_{Rdc} = 1600\text{ V}$ ;  $U_{Rac} = 550\text{ V}$ ;  $U_{p-p} = 1600\text{ V}$ ; C-tol. =  $\pm 5\%$

C ( $\mu\text{F}$ )	DIMENSIONS w x h (h') x l (mm)	MASS (g) <sup>(1)</sup>	CATALOG NUMBER BFC2 383 XXYYY AND PACKAGING					C-VALUE  ..YYY
			LOOSE IN BOX		REEL			
			Leads 3.5 $\pm$ 0.3	Leads 25.0 $\pm$ 2.0	Original pitch	Pitch = 7.5 mm (bent back)		
						$\varnothing$ 500 mm	$\varnothing$ 356 mm	
XX (SPQ)	XX (SPQ)	XX (SPQ)	XX (SPQ)	XX (SPQ)				
Pitch = 27.5 $\pm$ 0.4 mm; $d_t = 0.80\text{ mm} \pm 0.08\text{ mm}$			Pitch = 27.5 mm					
0.043	11.0 x 21.0 x 31.0	8	50... (100)	54... (125)		433		
0.047						473		
0.051						513		
0.056						563		
0.062	13.0 x 23.0 x 31.0	9.7	50... (100)	54... (125)		623		
0.068						683		
0.075						753		
0.082	15.0 x 25.0 x 31.0	12.6	50... (100)	54... (125)		823		
0.091						913		
0.1						104		
0.11	18.0 x 28.0 x 31.0	16.3	50... (100)	54... (100)	114			
0.12					124			
0.13					134			
0.15					154			

**Notes**

<sup>(1)</sup> Net weight for short lead products only

- SPQ = Standard Packaging Quantity

**SPECIFIC REFERENCE DATA (2000 Vdc)**

DESCRIPTION	VALUE	
	at 10 kHz	at 100 kHz
Tangent of loss angle: $C \leq 0.01\ \mu\text{F}$ $0.01\ \mu\text{F} < C \leq 0.1\ \mu\text{F}$	$\leq 5 \times 10^{-4}$ $\leq 10 \times 10^{-4}$	$\leq 15 \times 10^{-4}$ $\leq 18 \times 10^{-4}$
Rated voltage pulse slope (dU/dt) <sub>R</sub> : $C \leq 0.0036\ \mu\text{F}$ $0.0036\ \mu\text{F} < C \leq 0.01\ \mu\text{F}$ $0.01\ \mu\text{F} < C \leq 0.024\ \mu\text{F}$ $0.024\ \mu\text{F} < C \leq 0.068\ \mu\text{F}$ $0.068\ \mu\text{F} < C \leq 0.1\ \mu\text{F}$	11 000 V/ $\mu\text{s}$ 20 000 V/ $\mu\text{s}$ 4400 V/ $\mu\text{s}$ 2500 V/ $\mu\text{s}$ 1800 V/ $\mu\text{s}$	
R between leads, for $C \leq 1\ \mu\text{F}$ at 500 V, 1 min	> 100 000 M $\Omega$	
R between leads and case, 500 V, 1 min	> 30 000 M $\Omega$	
Ionization (AC) voltage (typical value) at 20 pC peak discharge	> 750 V	
Withstanding (DC) voltage (cut off current 10 mA), rise time 100 V/s	3200 V, 1 min	
Withstanding (DC) voltage between leads and case	2840 V, 1 min	
Maximum application temperature	105 °C	



AC and Pulse Double Metallized Polypropylene  
Film Capacitors MMKP Radial Potted Type

Vishay BCcomponents

$U_{Rdc} = 2000\text{ V}$ ;  $U_{Rac} = 700\text{ V}$ ;  $U_{p-p} = 2000\text{ V}$ ;  $C\text{-tol.} = \pm 5\%$

C ( $\mu\text{F}$ )	DIMENSIONS w x h (h') x l (mm)	MASS (g) <sup>(1)</sup>	CATALOG NUMBER BFC2 383 XXYYY AND PACKAGING					C-VALUE  ..YYY		
			LOOSE IN BOX		Original pitch	REEL				
			Leads 3.5 $\pm$ 0.3	Leads 25.0 $\pm$ 2.0		Pitch = 7.5 mm (bent back)				
			XX (SPQ)	XX (SPQ)	XX (SPQ)	XX (SPQ)	XX (SPQ)			
<b>Pitch = 15 mm <math>\pm</math> 0.4 mm; <math>d_t = 0.80\text{ mm} \pm 0.08\text{ mm}</math></b>					<b>Pitch = 15 mm</b>	<b>Pitch = 7.5 mm (bent back)</b>				
0.001	5.0 x 11.0 (13.0) x 17.5	1.1						102		
0.0011								112		
0.0012								122		
0.0013								132		
0.0015								152		
0.0016					60... (1250)	64... (1000)	62... (1100)	63... (950)	65... (550)	162
0.0018									182	
0.002									202	
0.0022									222	
0.0024									242	
0.0027	6.0 x 12.0 (14.0) x 17.5	1.4						272		
0.003								302		
0.0033					60... (1000)	64... (1000)	62... (900)	63... (800)	65... (450)	332
0.0036									362	
0.0039	7.0 x 13.5 (15.5) x 17.5	1.8						392		
0.0043					60... (750)	64... (500)	62... (800)	63... (700)	65... (400)	432
0.0047									472	
0.0051	8.5 x 15.0 (17.0) x 17.5	2.5						512		
0.0056					60... (750)	64... (500)	62... (650)	63... (550)	65... (300)	562
0.0062									622	
0.0068									682	
0.0075	10.0 x 16.5 (18.5) x 17.5	3.3						752		
0.0082					60... (500)	64... (450)	62... (600)	63... (500)	65... (250)	822
0.0091									912	
0.01									103	
<b>Pitch = 22.5 mm <math>\pm</math> 0.4 mm; <math>d_t = 0.80\text{ mm} \pm 0.08\text{ mm}</math></b>					<b>Pitch = 22.5 mm</b>					
0.011	7.0 x 16.5 x 26.0	3.0						113		
0.012					60... (200)	64... (250)	62... (550)	-	-	123
0.013									133	
0.015	8.5 x 18.0 x 26.0	4.2						153		
0.016					60... (200)	64... (250)	62... (450)	-	-	163
0.018									183	
0.02	10.0 x 19.5 x 26.0	5.3						203		
0.022					60... (200)	64... (200)	62... (350)	-	-	223
0.024									243	
<b>Pitch = 27.5 mm <math>\pm</math> 0.4 mm; <math>d_t = 0.80\text{ mm} \pm 0.08\text{ mm}</math></b>					<b>Pitch = 27.5 mm</b>					
0.027	11.0 x 21.0 x 31.0	8.0						273		
0.03									303	
0.033					60... (100)	64... (125)			333	
0.036									363	
0.039									393	

**Notes**

- (1) Net weight for short lead products only
- SPQ = Standard Packaging Quantity



AC and Pulse Double Metallized Polypropylene  
Film Capacitors MMKP Radial Potted Type

Vishay BCcomponents

C ( $\mu\text{F}$ )	DIMENSIONS w x h (h') x l (mm)	MASS (g) <sup>(1)</sup>	CATALOG NUMBER BFC2 383 XXYYY AND PACKAGING					C-VALUE  ..YYY
			LOOSE IN BOX		REEL			
			Leads 3.5 $\pm$ 0.3	Leads 25.0 $\pm$ 2.0	Original pitch	Pitch = 7.5 mm (bent back)		
			XX (SPQ)	XX (SPQ)		$\varnothing$ 500 mm	$\varnothing$ 356 mm	
Pitch = 27.5 mm $\pm$ 0.4 mm; $d_t$ = 0.80 mm $\pm$ 0.08 mm			Pitch = 27.5 mm					
0.043 0.047 0.051	13.0 x 23.0 x 31.0	9.7	60... (100)	64... (125)		433 473 513		
0.056 0.062 0.068	15.0 x 25.0 x 31.0	12.6	60... (100)	64... (125)		563 623 683		
0.075 0.082 0.091 0.10	18.0 x 28.0 x 31.0	16.3	60... (100)	64... (100)		753 823 913 104		

**Notes**

- (1) Net weight for short lead products only
- SPQ = Standard Packaging Quantity

**SPECIFIC REFERENCE DATA (2500 Vdc)**

DESCRIPTION	VALUE	
Tangent of loss angle: C $\leq$ 0.015 $\mu\text{F}$ 0.015 $\mu\text{F}$ < C $\leq$ 0.056 $\mu\text{F}$	at 10 kHz	at 100 kHz
	$\leq 5 \times 10^{-4}$	$\leq 10 \times 10^{-4}$
	$\leq 5 \times 10^{-4}$	$\leq 15 \times 10^{-4}$
Rated voltage pulse slope (dU/dt) <sub>R</sub> : C $\leq$ 0.015 $\mu\text{F}$ 0.015 $\mu\text{F}$ < C $\leq$ 0.043 $\mu\text{F}$ 0.043 $\mu\text{F}$ < C $\leq$ 0.056 $\mu\text{F}$	13 000 V/ $\mu\text{s}$	
	6000 V/ $\mu\text{s}$	
	4200 V/ $\mu\text{s}$	
R between leads, for C $\leq$ 1 $\mu\text{F}$ at 500 V, 1 min	> 100 000 M $\Omega$	
R between leads and case, 500 V, 1 min	> 30 000 M $\Omega$	
Ionization (AC) voltage (typical value) at 20 pC peak discharge	> 1000 V	
Withstanding (DC) voltage (cut off current 10 mA), rise time 100 V/s	3500 V, 1 min	
Withstanding (DC) voltage between leads and case	2840 V, 1 min	
Maximum application temperature	105 °C	



AC and Pulse Double Metallized Polypropylene  
Film Capacitors MMKP Radial Potted Type

Vishay BCcomponents

$U_{Rdc} = 2500\text{ V}$ ;  $U_{Rac} = 900\text{ V}$ ;  $U_{p-p} = 2500\text{ V}$ ;  $C\text{-tol.} = \pm 5\%$

C ( $\mu\text{F}$ )	DIMENSIONS w x h x l (mm)	MASS (g) <sup>(1)</sup>	CATALOG NUMBER BFC2 383 XXYYY AND PACKAGING			
			LOOSE IN BOX		REEL	C-VALUE
			Leads 3.5 $\pm$ 0.3 mm	Leads 25.0 $\pm$ 2.0 mm	H = 18.5 mm	..YYY
			XX (SPQ)	XX (SPQ)	XX (SPQ)	
<b>Pitch = 22.5 mm <math>\pm</math> 0.4 mm; <math>d_t = 0.80\text{ mm} \pm 0.08\text{ mm}</math></b>						
0.001	6.0 x 15.5 x 26.0	2.4	70... (200)	74... (250)	72... (600)	102
0.0011						112
0.0012						122
0.0013						132
0.0015						152
0.0016						162
0.0018						182
0.002						202
0.0022						222
0.0024						242
0.0027						272
0.003						302
0.0033						332
0.0036						362
0.0039						392
0.0043	432					
0.0047	472					
0.0051	512					
0.0056	7.0 x 16.5 x 26.0	3.0	70... (200)	74... (250)	72... (550)	562
0.0062						622
0.0068						682
0.0075						752
0.0082	8.5 x 18.0 x 26.0	4.2	70... (200)	74... (250)	72... (450)	822
0.0091						912
0.01						103
0.011	113					
0.012	10.0 x 19.5 x 26.0	5.3	70... (200)	74... (200)	72... (350)	123
0.013						133
0.015						153
<b>Pitch = 27.5 mm <math>\pm</math> 0.4 mm; <math>d_t = 0.80\text{ mm} \pm 0.08\text{ mm}</math></b>						
0.016	9.0 x 19.0 x 31.0	5.9	70...	74...		163
0.018	11.0 x 21.0 x 31.0	8.0	70... (100)	74... (125)		183
0.02						203
0.022						223
0.024						243
0.027						273
0.03	13.0 x 23.0 x 31.0	9.7	70... (100)	74... (125)		303
0.033						333
0.036						363
0.039	15.0 x 25.0 x 31.0	12.6	70... (100)	74... (125)		393
0.043						433
0.047						473
0.051	18.0 x 28.0 x 31.0	16.3	70... (100)	74... (100)		513
0.056						563

**Notes**

<sup>(1)</sup> Net weight for short lead products only

- SPQ = Standard Packaging Quantity



**MOUNTING**

**Normal Use**

The capacitors are designed for mounting on printed-circuit boards. The capacitors packed in bandoliers are designed for mounting on printed-circuit boards by means of automatic insertion machines. For detailed tape specifications refer to "Packaging Information" [www.vishay.com/docs?28139](http://www.vishay.com/docs?28139)

**Specific Method of Mounting to Withstand Vibration and Shock**

In order to withstand vibration and shock tests, it must be ensured that the stand-off pips are in good contact with the printed-circuit board:

- For original pitch = 15 mm the capacitors shall be mechanically fixed by the leads
- For larger pitches the capacitors shall be mounted in the same way and the body clamped

**Space Requirements on Printed-Circuit Board**

The maximum length and width of film capacitors is shown in the drawing:

- Eccentricity as in drawing. The maximum eccentricity is smaller than or equal to the lead diameter of the product concerned
- Product height with seating plane as given by "IEC 60717" as reference:  $h_{max.} \leq h + 0.3 \text{ mm}$

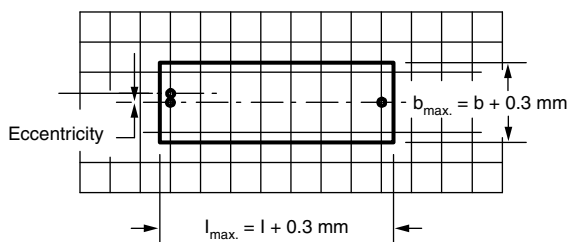

**Storage Temperature**

- Storage temperature:  $T_{stg} = - 25 \text{ }^{\circ}\text{C}$  to  $+ 40 \text{ }^{\circ}\text{C}$  with RH maximum 80 % without condensation

**Ratings and Characteristics Reference Conditions**

Unless otherwise specified, all electrical values apply to an ambient free temperature of  $23 \text{ }^{\circ}\text{C} \pm 1 \text{ }^{\circ}\text{C}$ , an atmospheric pressure of 86 kPa to 106 kPa and a relative humidity of  $50 \% \pm 2 \%$ .

For reference testing, a conditioning period shall be applied over  $96 \text{ h} \pm 4 \text{ h}$  by heating the products in a circulating air oven at the rated temperature and a relative humidity not exceeding 20 %.



AC and Pulse Double Metallized Polypropylene Film Capacitors MMKP Radial Potted Type

Vishay BCcomponents

**CHARACTERISTICS**

Capacitance as a function of ambient temperature (typical curve) (1 kHz)

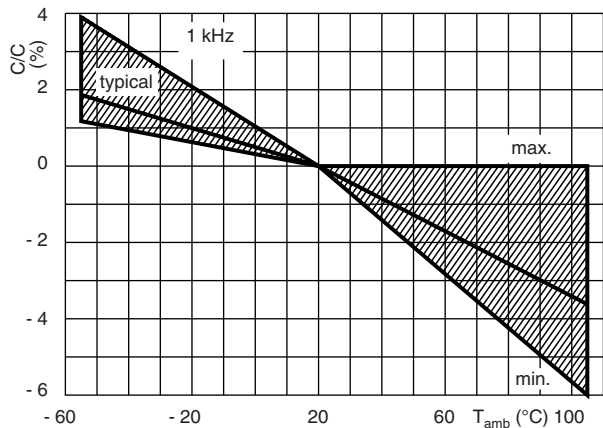

Impedance as a function of frequency (typical curve)

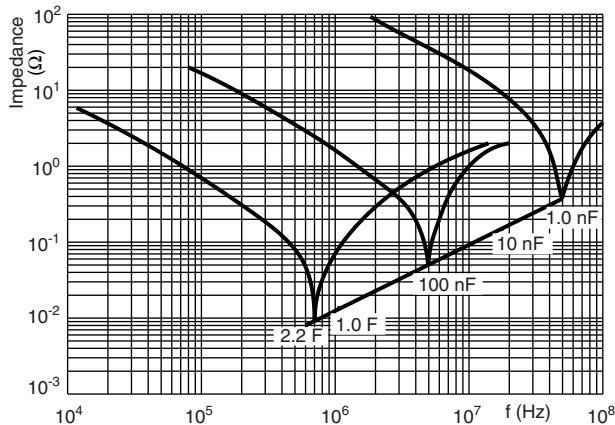

Max. DC and AC voltage as function of temperature

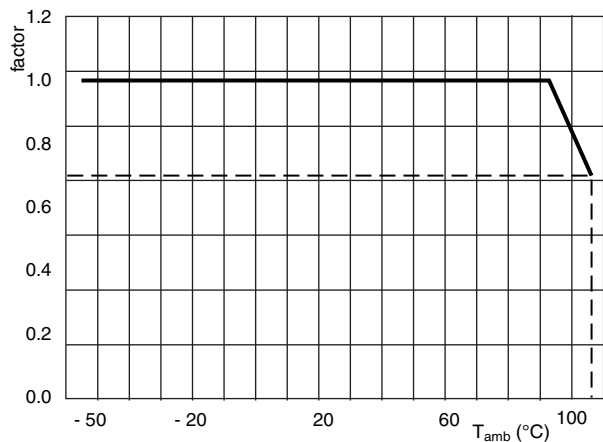

Max. RMS voltage as a function of frequency

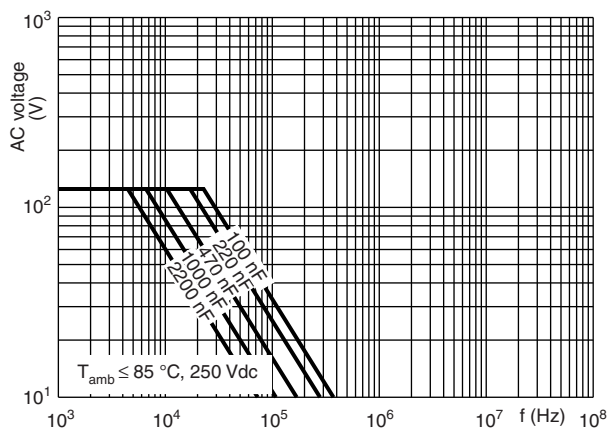

Max. RMS voltage as a function of frequency

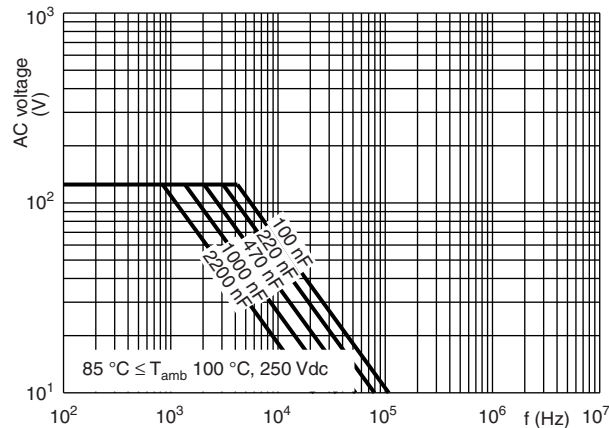





AC and Pulse Double Metallized Polypropylene Film Capacitors MMKP Radial Potted Type

Vishey BCcomponents

Max. RMS voltage as a function of frequency

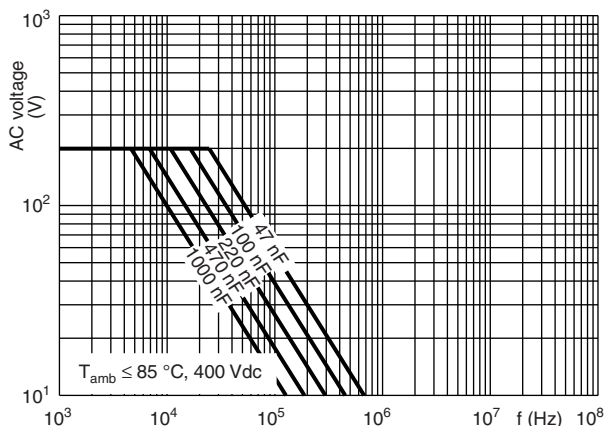

Max. RMS voltage as a function of frequency

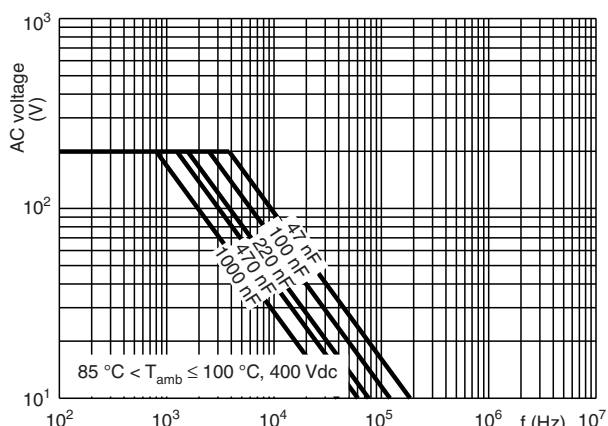

Max. RMS voltage as a function of frequency

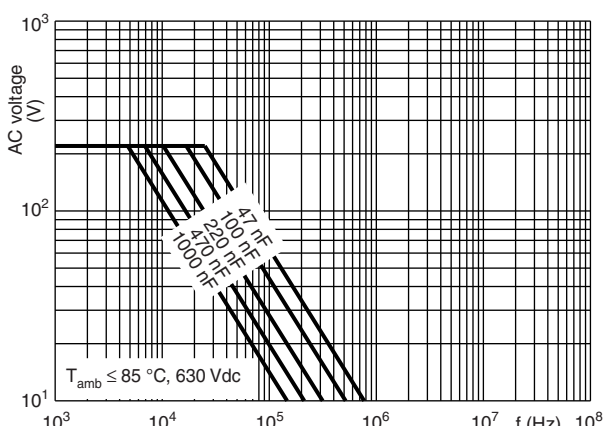

Max. RMS voltage as a function of frequency

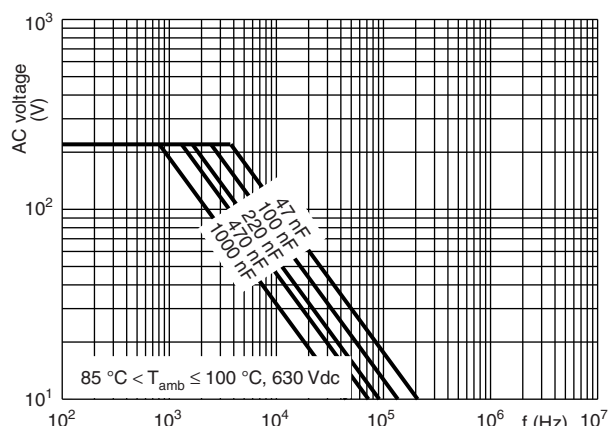

Max. RMS voltage as a function of frequency

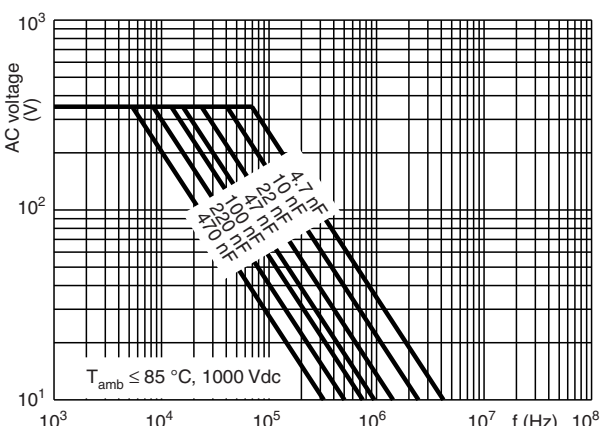

Max. RMS voltage as a function of frequency

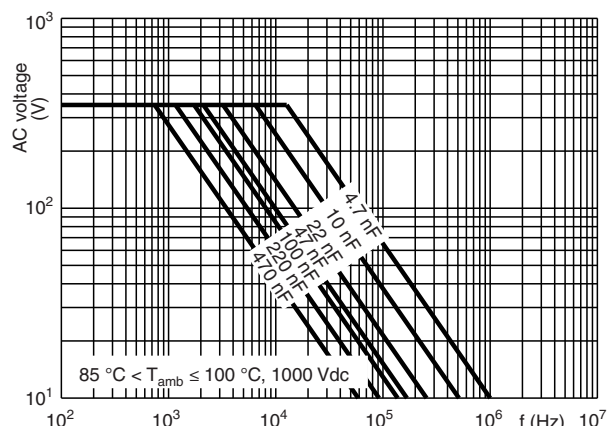



AC and Pulse Double Metallized Polypropylene Film Capacitors MMKP Radial Potted Type

Vishay BCcomponents

Max. RMS voltage as a function of frequency

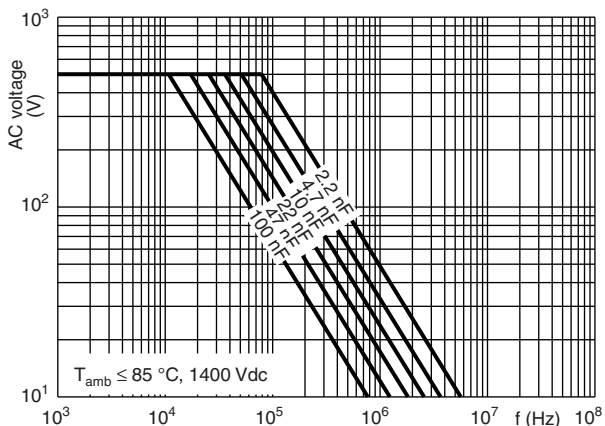

Max. RMS voltage as a function of frequency

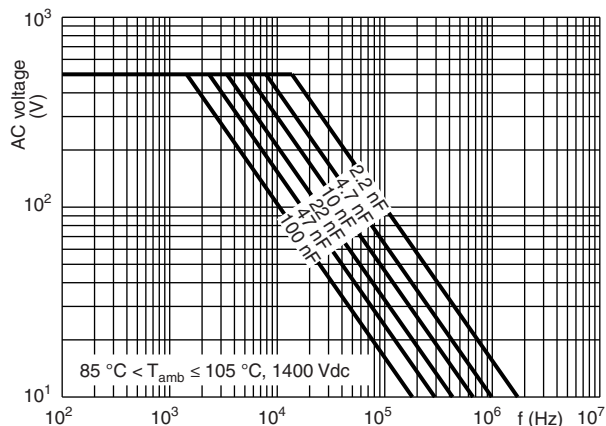

Max. RMS voltage as a function of frequency

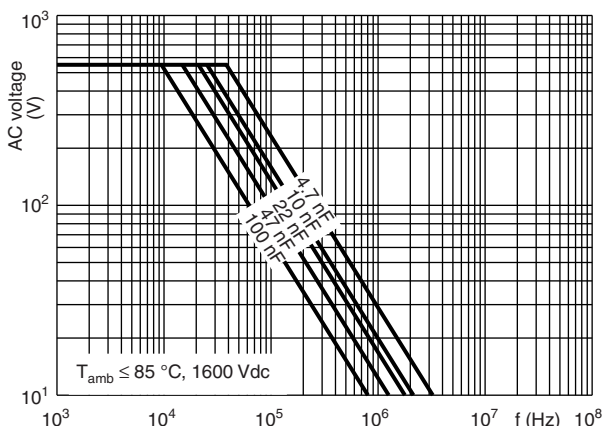

Max. RMS voltage as a function of frequency

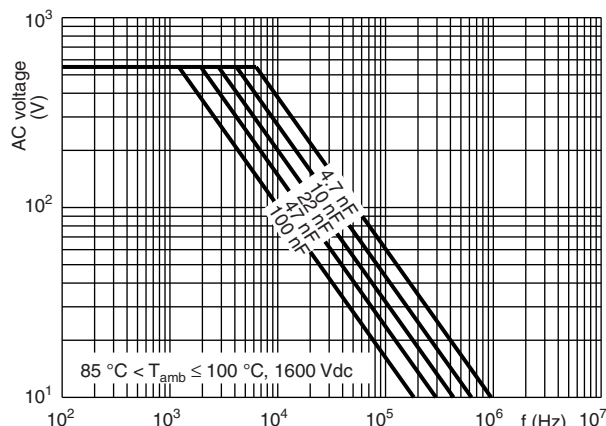

Max. RMS voltage as a function of frequency

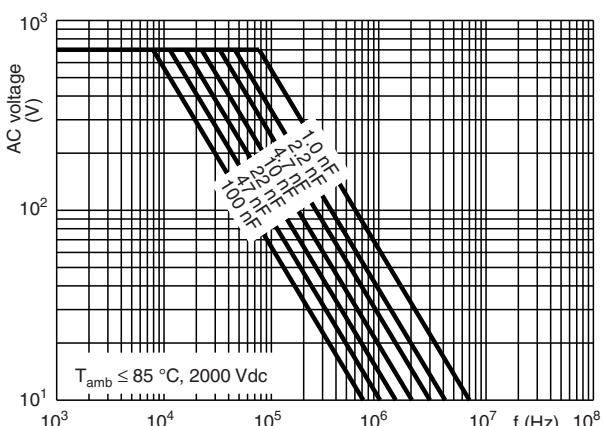

Max. RMS voltage as a function of frequency

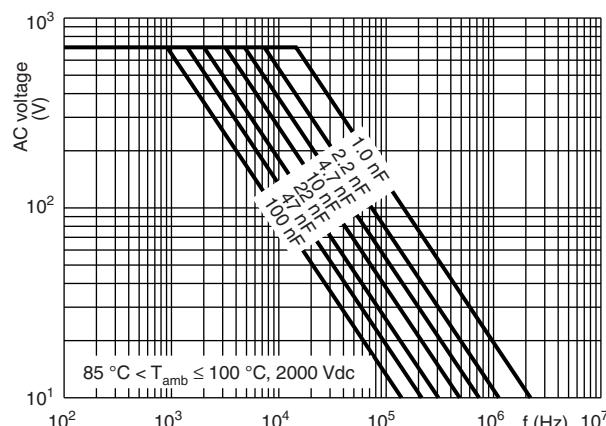



AC and Pulse Double Metallized Polypropylene Film Capacitors MMKP Radial Potted Type

Vishay BCcomponents

Max. RMS voltage as a function of frequency

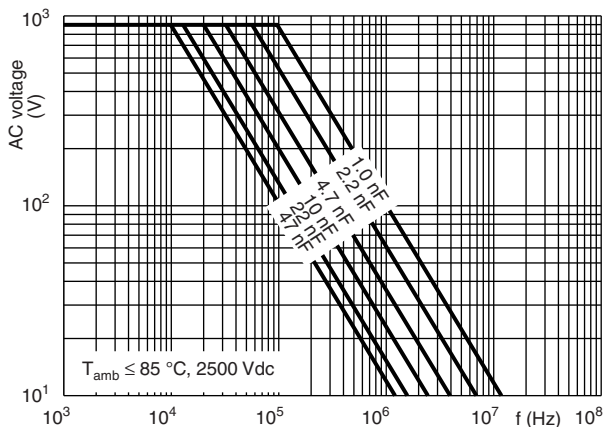

Max. RMS voltage as a function of frequency

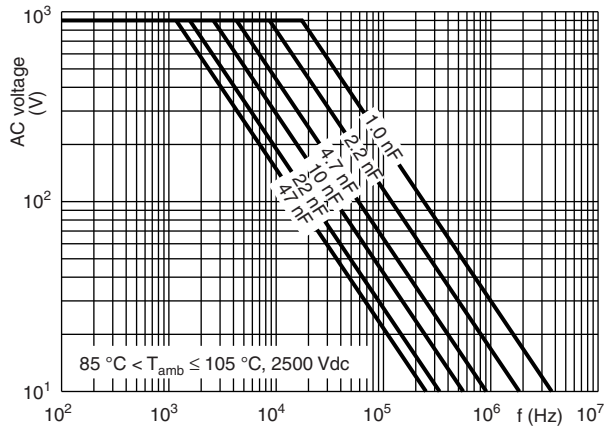

Insulation resistance as a function of ambient temperature

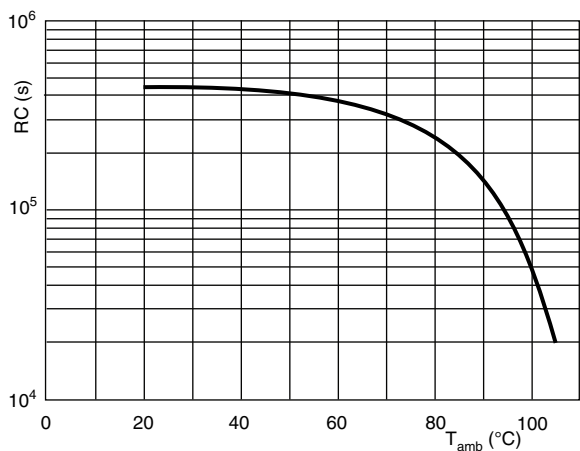

Max. allowed component temperature rise ( $\Delta T$ ) as a function of the ambient temperature ( $T_{amb}$ )

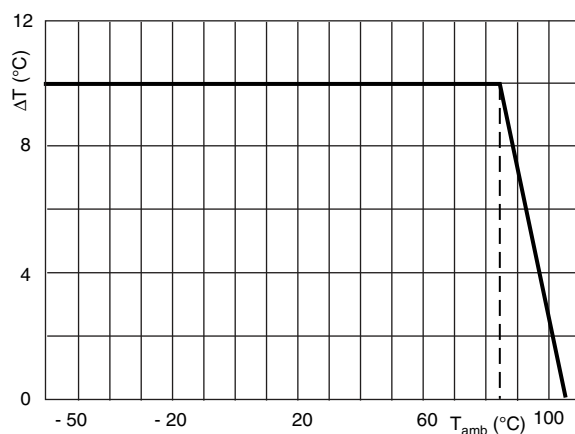



AC and Pulse Double Metallized Polypropylene Film Capacitors MMKP Radial Potted Type

Vishay BCcomponents

Tangent of loss angle as a function of frequency (typical curve)

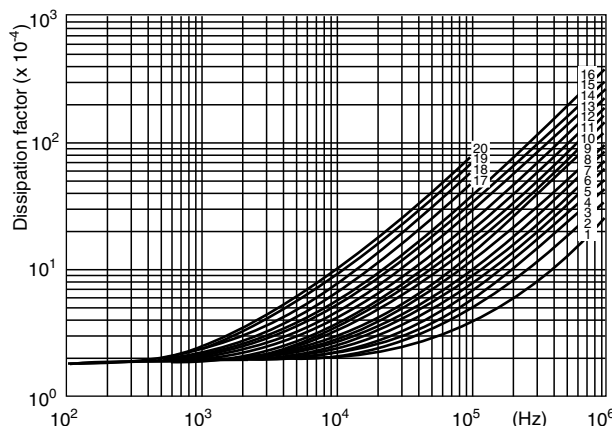

<b>250 V</b> C ≤ 0.091 μF, curve 8 C ≤ 0.015 μF, curve 9 C ≤ 0.022 μF, curve 10 C ≤ 0.027 μF, curve 11 C ≤ 0.033 μF, curve 12 C ≤ 0.056 μF, curve 15 C ≤ 0.082 μF, curve 16 C ≤ 1.2 μF, curve 18 C ≤ 1.61 μF, curve 19 C ≤ 2.21 μF, curve 20	<b>400 V</b> C ≤ 0.047 μF, curve 5 C ≤ 0.068 μF, curve 6 C ≤ 0.1 μF, curve 7 C ≤ 0.2 μF, curve 8 C ≤ 0.24 μF, curve 12 C ≤ 0.36 μF, curve 13 C ≤ 0.43 μF, curve 14 C ≤ 0.56 μF, curve 16 C ≤ 1.1 μF, curve 17	<b>630 V</b> C ≤ 0.033 μF, curve 4 C ≤ 0.068 μF, curve 5 C ≤ 0.1 μF, curve 6 C ≤ 0.15 μF, curve 7 C ≤ 0.22 μF, curve 11 C ≤ 0.27 μF, curve 12 C ≤ 0.47 μF, curve 15 C ≤ 0.68 μF, curve 16	<b>1000 V</b> C ≤ 0.01 μF, curve 2 C ≤ 0.027 μF, curve 3 C ≤ 0.047 μF, curve 4 C ≤ 0.062 μF, curve 5 C ≤ 0.075 μF, curve 6 C ≤ 0.1 μF, curve 7 C ≤ 0.15 μF, curve 8 C ≤ 0.22 μF, curve 9 C ≤ 0.3 μF, curve 10 C ≤ 0.39 μF, curve 11 C ≤ 0.47 μF, curve 12
<b>140 V</b> C ≤ 0.0047 μF, curve 1 C ≤ 0.016 μF, curve 2 C ≤ 0.033 μF, curve 3 C ≤ 0.051 μF, curve 4 C ≤ 0.068 μF, curve 5 C ≤ 0.082 μF, curve 6 C ≤ 0.1 μF, curve 7	<b>1600 V</b> C ≤ 0.0047 μF, curve 3 C ≤ 0.0091 μF, curve 4 C ≤ 0.068 μF, curve 5 C ≤ 0.01 μF, curve 6 C ≤ 0.15 μF, curve 7	<b>2000 V</b> C ≤ 0.0047 μF, curve 2 C ≤ 0.033 μF, curve 3 C ≤ 0.1 μF, curve 4	<b>2500 V</b> C ≤ 0.0047 μF, curve 1 C ≤ 0.015 μF, curve 2 C ≤ 0.056 μF, curve 3

HEAT CONDUCTIVITY (G) AS A FUNCTION OF (ORIGINAL) PITCH AND CAPACITOR BODY THICKNESS IN mW/°C

W <sub>max.</sub> (mm)	HEAT CONDUCTIVITY (mW/°C)		
	PITCH 15 mm	PITCH 22.5 mm	PITCH 27.5 mm
4.0	-	-	-
5.0	10	-	-
6.0	11	19	-
7.0	12	21	-
8.5	16	25	-
10.0	18	28	-
11.0	-	-	36
13.0	-	-	42
15.0	-	-	48
18.0	-	-	57



**POWER DISSIPATION AND MAXIMUM COMPONENT TEMPERATURE RISE**

The power dissipation must be limited in order not to exceed the maximum allowed component temperature rise as a function of the free air ambient temperature. The power dissipation can be calculated according type detail specification “HQN-384-01/101: Technical Information Film Capacitors”.

The component temperature rise ( $\Delta T$ ) can be measured (see section “Measuring the component temperature” for more details) or calculated by  $\Delta T = P/G$ :

- $\Delta T$  = Component temperature rise ( $^{\circ}C$ )
- P = Power dissipation of the component (mW)
- G = Heat conductivity of the component (mW/ $^{\circ}C$ )

**MEASURING THE COMPONENT TEMPERATURE**

A thermocouple must be attached to the capacitor body as in:

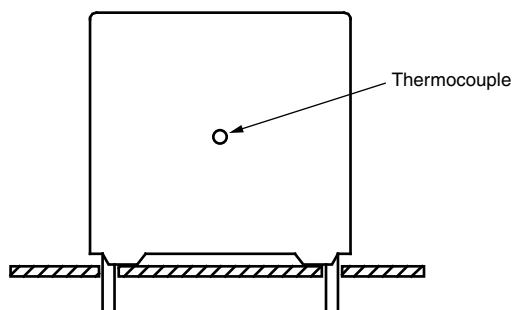

The temperature is measured in unloaded ( $T_{amb}$ ) and maximum loaded condition ( $T_C$ ). The temperature rise is given by  $\Delta T = T_C - T_{amb}$ . To avoid radiation or convection, the capacitor should be tested in a wind-free box.

**APPLICATION NOTE AND LIMITING CONDITIONS**

These capacitors are not suitable for mains applications as across-the-line capacitors without additional protection, as described hereunder. These mains applications are strictly regulated in safety standards and therefore electromagnetic interference suppression capacitors conforming the standards must be used.

To select the capacitor for a certain application, the following conditions must be checked:

1. The peak voltage ( $U_P$ ) shall not be greater than the rated DC voltage ( $U_{Rdc}$ )
2. The peak-to-peak voltage ( $U_{P-P}$ ) shall not be greater than  $2\sqrt{2} \times U_{Rac}$  to avoid the ionisation inception level
3. The voltage pulse slope ( $dU/dt$ ) shall not exceed the rated voltage pulse slope in an RC-circuit at rated voltage and without ringing. If the pulse voltage is lower than the rated DC voltage, the rated voltage pulse slope may be multiplied by  $U_{Rdc}$  and divided by the applied voltage.

For all other pulses following equation must be fulfilled:

$$2 \times \int_0^T \left(\frac{dU}{dt}\right)^2 \times dt < U_{Rdc} \times \left(\frac{dU}{dt}\right)_{rated}$$

T is the pulse duration.

4. The maximum component surface temperature rise must be lower than the limits (see graph max. allowed component temperature rise).
5. Since in circuits used at voltages over 280 V peak-to-peak the risk for an intrinsically active flammability after a capacitor breakdown (short circuit) increases, it is recommended that the power to the component is limited to 100 times the values mentioned in the table: “Heat Conductivity”



AC and Pulse Double Metallized Polypropylene Film Capacitors MMKP Radial Potted Type

Vishay BCcomponents

6. When using these capacitors as across-the-line capacitor in the input filter for mains applications or as series connected with an impedance to the mains the applicant must guarantee that the following conditions are fulfilled in any case (spikes and surge voltages from the mains included).

**Voltage Conditions for 6 Above**

ALLOWED VOLTAGES	$T_{amb} \leq 85\text{ }^{\circ}\text{C}$	$85\text{ }^{\circ}\text{C} < T_{amb} \leq 105\text{ }^{\circ}\text{C}$
Maximum continuous RMS voltage	$U_{Rac}$	$U_{Rac}$
Maximum temperature RMS-overvoltage (< 24 h)	$1.25 \times U_{Rac}$	$1.25 \times U_{Rac}$
Maximum peak voltage ( $V_{O-P}$ ) (< 2 s)	$1.6 \times U_{Rdc}$	$1.1 \times U_{Rdc}$

**EXAMPLE**

C = 4 nF - 1600 V used for the voltage signal shown in next drawing.  
 $U_{P-P} = 1000\text{ V}$ ;  $U_P = 900\text{ V}$ ;  $T_1 = 12\text{ }\mu\text{s}$ ;  $T_2 = 64\text{ }\mu\text{s}$ ;  $T_3 = 4\text{ }\mu\text{s}$   
 The ambient temperature is 80 °C. In case of failure, the oscillation is blocked.

Checking conditions:

1. The peak voltage  $U_P = 900\text{ V}$  is lower than 1600 Vdc
2. The peak-to-peak voltage 1000 V is lower than  $2\sqrt{2} \times 550\text{ Vac} = 1600\text{ V}$
3. The voltage pulse slope  $(dU/dt) = 1000\text{ V}/4\text{ }\mu\text{s} = 250\text{ V}/\mu\text{s}$   
 This is lower than 8000 V/ $\mu\text{s}$  (see specific reference data for each version)
4. The dissipated power is 35 mW as calculated with fourier terms and typical tg $\delta$ .  
 The temperature rise for  $W_{max.} = 6.0\text{ mm}$  and pitch = 15 mm will be  $35\text{ mW}/11\text{ mW}/^{\circ}\text{C} = 3.2\text{ }^{\circ}\text{C}$   
 This is lower than 10 °C temperature rise at 80 °C, according graph.
5. Oscillation is blocked
6. Not applicable

**Voltage Signal**

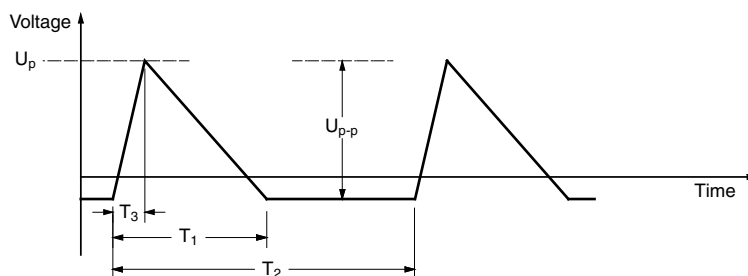



AC and Pulse Double Metallized Polypropylene  
Film Capacitors MMKP Radial Potted Type

Vishay BCcomponents

**INSPECTION REQUIREMENTS**

**General Notes:**

Sub-clause numbers of tests and performance requirements refer to the “Sectional Specification, Publication IEC 60384-17 and Specific Reference Data”.

**Group C Inspection Requirements**

SUB-CLAUSE NUMBER AND TEST	CONDITIONS	PERFORMANCE REQUIREMENTS
<b>SUB-GROUP C1A PART OF SAMPLE OF SUB-GROUP C1</b>		
4.1 Dimensions (detail)		As specified in chapters “General Data” of this specification
4.3.1 Initial measurements	Capacitance Tangent of loss angle: For C ≤ 1 μF at 100 kHz or for C > 1 μF at 10 kHz	
4.3 Robustness of terminations	Tensile: Load 10 N; 10 s Bending: Load 5 N; 4 x 90°	No visible damage
4.4 Resistance to soldering heat	Method: 1A Solder bath: 280 °C ± 5 °C Duration: 10 s	
4.14 Component solvent resistance	Isopropylalcohol at room temperature Method: 2 Immersion time: 5 min ± 0.5 min Recovery time: Min. 1 h, max. 2 h	
4.4.2 Final measurements	Visual examination  Capacitance  Tangent of loss angle	No visible damage Legible marking   ΔC/C  ≤ 1 % of the value measured initially  Increase of tan δ ≤ 0.0005 for: C ≤ 100 nF or ≤ 0.001 for: 100 nF < C ≤ 470 nF or ≤ 0.0015 for: C > 470 nF Compared to values measured in 4.3.1
<b>SUB-GROUP C1B OTHER PART OF SAMPLE OF SUB-GROUP C1</b>		
4.6.1 Initial measurements	Capacitance Tangent of loss angle: For C ≤ 1 μF at 100 kHz or for C > 1 μF at 10 kHz	
4.15 Solvent resistance of the marking	Isopropylalcohol at room temperature Method: 1 Rubbing material: cotton wool	No visible damage Legible marking
4.6 Rapid change of temperature	Immersion time: 5.0 min ± 0.5 min θA = - 55 °C θB = + 105 °C 5 cycles Duration t = 30 min	
4.7 Vibration	Visual examination Mounting: see section “Mounting” for more information Procedure B4 Frequency range: 10 Hz to 55 Hz Amplitude: 0.75 mm or Acceleration 98 m/s <sup>2</sup> (whichever is less severe) Total duration 6 h	No visible damage



AC and Pulse Double Metallized Polypropylene  
Film Capacitors MMKP Radial Potted Type

Vishay BCcomponents

SUB-CLAUSe NUMBER AND TEST	CONDITIONS	PERFORMANCE REQUIREMENTS
<b>SUB-GROUP C1B OTHER PART OF SAMPLE OF SUB-GROUP C1</b>		
4.7.2 Final inspection 4.9 Shock  4.9.3 Final measurements	Visual examination Mounting: See section "Mounting" for more information Pulse shape: Half sine Acceleration: 490 m/s <sup>2</sup> Duration of pulse: 11 ms  Visual examination Capacitance Tangent of loss angle  Insulation resistance	No visible damage  No visible damage $ \Delta C/C  \leq 1\%$ of the value measured in 4.6.1 Increase of tan $\delta$ $\leq 0.0005$ for: $C \leq 100$ nF or $\leq 0.001$ for: $100$ nF < $C \leq 470$ nF or $\leq 0.0015$ for: $C > 470$ nF Compared to values measured in 4.6.1 As specified in section "Insulation Resistance" of this specification
<b>SUB-GROUP C1 COMBINED SAMPLE OF SPECIMENS OF SUB-GROUPS C1A AND C1B</b>		
4.10 Climatic sequence 4.10.2 Dry heat  4.10.3 Damp heat cyclic Test Db, first cycle 4.10.4 Cold  4.10.6 Damp heat cyclic Test Db, remaining cycles 4.10.6.2 Final measurements	Temperature: + 105 °C Duration: 16 h  Temperature: - 55 °C Duration: 2 h  Voltage proof = $U_{Rdc}$ for 1 min within 15 min after removal from testchamber Visual examination  Capacitance  Tangent of loss angle  Insulation resistance	No breakdown of flash-over  No visible damage Legible marking For original pitch = 22.5 mm and 27.5 mm: $ \Delta C/C  \leq 3\%$ of the value measured in 4.4.2 or 4.9.3 Increase of tan $\delta$ $\leq 0.0005$ for: $C \leq 100$ nF or $\leq 0.001$ for: $100$ nF < $C \leq 470$ nF or $\leq 0.0015$ for: $C > 470$ nF Compared to values measured in 4.3.1 or 4.6.1 $\geq 50\%$ of values specified in section "Insulation Resistance" of this specification
<b>SUB-GROUP C2</b>		
4.11 Damp heat steady state 4.11.1 Initial measurements 4.11.3 Final measurements	56 days, 40 °C, 90 % to 95 % RH no load Capacitance Tangent of loss angle at 1 kHz Voltage proof = $U_{Rdc}$ for 1 min within 15 min after removal from testchamber Visual examination  Capacitance  Tangent of loss angle  Insulation resistance	No breakdown of flash-over  No visible damage Legible marking $ \Delta C/C  \leq 1\%$ of the value measured in 4.11.1. Increase of tan $\delta$ $\leq 0.0005$ for: $C \leq 100$ nF or $\leq 0.001$ for: $100$ nF < $C \leq 470$ nF or $\leq 0.0015$ for: $C \leq 470$ nF Compared to values measured in 4.11.1 $\geq 50\%$ of values specified in section "Insulation Resistance" of this specification





AC and Pulse Double Metallized Polypropylene  
Film Capacitors MMKP Radial Potted Type

Vishay BCcomponents

SUB-CLAUSE NUMBER AND TEST	CONDITIONS	PERFORMANCE REQUIREMENTS
<b>SUB-GROUP C3A</b>		
4.12.1 Endurance test at 50 Hz alternating voltage	Duration: 2000 h 1.25 x U <sub>Rdc</sub> at 105 °C	No visible damage Legible marking  $ \Delta C/C  \leq 5\%$ compared to values measured in 4.12.1.1  Increase of tan $\delta$ $\leq 0.0005$ for: C $\leq$ 100 nF or $\leq 0.001$ for: 100 nF < C $\leq$ 470 nF or $\leq 0.0015$ for: C > 470 nF Compared to values measured in 4.12.1.1  $\geq 50\%$ of values specified in section "Insulation Resistance" of this specification
4.12.1.1 Initial measurements	Capacitance Tangent of loss angle: For C $\leq$ 1 $\mu$ F at 100 kHz or for C > 1 $\mu$ F at 10 kHz	
4.12.1.3 Final measurements	Visual examination  Capacitance  Tangent of loss angle	
	Insulation resistance	
<b>SUB-GROUP C4</b>		
4.2.6 Temperature characteristics Initial measurements Intermediate measurements  Final measurements	Capacitance Capacitance at - 55 °C Capacitance at 20 °C Capacitance at + 105 °C Capacitance  Insulation resistance	For - 55 °C to + 20 °C: $+ 1\% \leq  \Delta C/C  \leq 3.75\%$ or for 20 °C to 105 °C: $- 6\% \leq  \Delta C/C  \leq 0\%$ As specified in section "Capacitance" of this specification. As specified in section "Insulation Resistance" of this specification
4.13 Charge and discharge	10 000 cycles Charged to U <sub>Rdc</sub> Discharge resistance:  $R = \frac{U_{Rdc}}{5 \times C \times (2.5 \times dU/dt)}$	
4.13.1 Initial measurements	Capacitance Tangent of loss angle: For C $\leq$ 1 $\mu$ F at 100 kHz or for C > 1 $\mu$ F at 10 kHz	
4.13.3 Final measurements	Capacitance  Tangent of loss angle	
	Insulation resistance	



## **Disclaimer**

ALL PRODUCT, PRODUCT SPECIFICATIONS AND DATA ARE SUBJECT TO CHANGE WITHOUT NOTICE TO IMPROVE RELIABILITY, FUNCTION OR DESIGN OR OTHERWISE.

Vishay Intertechnology, Inc., its affiliates, agents, and employees, and all persons acting on its or their behalf (collectively, "Vishay"), disclaim any and all liability for any errors, inaccuracies or incompleteness contained in any datasheet or in any other disclosure relating to any product.

Vishay makes no warranty, representation or guarantee regarding the suitability of the products for any particular purpose or the continuing production of any product. To the maximum extent permitted by applicable law, Vishay disclaims (i) any and all liability arising out of the application or use of any product, (ii) any and all liability, including without limitation special, consequential or incidental damages, and (iii) any and all implied warranties, including warranties of fitness for particular purpose, non-infringement and merchantability.

Statements regarding the suitability of products for certain types of applications are based on Vishay's knowledge of typical requirements that are often placed on Vishay products in generic applications. Such statements are not binding statements about the suitability of products for a particular application. It is the customer's responsibility to validate that a particular product with the properties described in the product specification is suitable for use in a particular application. Parameters provided in datasheets and / or specifications may vary in different applications and performance may vary over time. All operating parameters, including typical parameters, must be validated for each customer application by the customer's technical experts. Product specifications do not expand or otherwise modify Vishay's terms and conditions of purchase, including but not limited to the warranty expressed therein.

Hyperlinks included in this datasheet may direct users to third-party websites. These links are provided as a convenience and for informational purposes only. Inclusion of these hyperlinks does not constitute an endorsement or an approval by Vishay of any of the products, services or opinions of the corporation, organization or individual associated with the third-party website. Vishay disclaims any and all liability and bears no responsibility for the accuracy, legality or content of the third-party website or for that of subsequent links.

Vishay products are not designed for use in life-saving or life-sustaining applications or any application in which the failure of the Vishay product could result in personal injury or death unless specifically qualified in writing by Vishay. Customers using or selling Vishay products not expressly indicated for use in such applications do so at their own risk. Please contact authorized Vishay personnel to obtain written terms and conditions regarding products designed for such applications.

No license, express or implied, by estoppel or otherwise, to any intellectual property rights is granted by this document or by any conduct of Vishay. Product names and markings noted herein may be trademarks of their respective owners.