

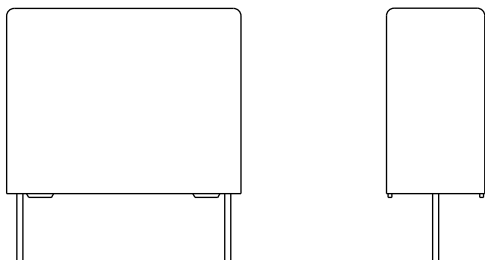

## AC and Pulse Metallized Polypropylene Film Capacitors MKP Radial Potted Type



### FEATURES

- Low loss dielectric
- Material categorization:  
for definitions of compliance please see [www.vishay.com/doc?99912](http://www.vishay.com/doc?99912)

### APPLICATIONS

Low losses due to low contact resistance and low loss dielectric make these products suitable for applications where high currents at high frequency occur or high stability is preferred. Their small dimensions make them ideal for circuits with high packaging density.



QUICK REFERENCE DATA	
Capacitance range (E24 series)	0.01 $\mu$ F to 6.2 $\mu$ F
Capacitance tolerance	$\pm$ 5 %
Climatic category	55/085/56
Maximum application temperature	85 °C
Reference specifications	IEC 60384-17
Dielectric	Polypropylene film
Electrodes	Metallized film
Construction	Wound mono construction
Encapsulation	Flame retardant plastic case and epoxy resin (UL-class 94 V-0)
Leads	Tinned wire
Marking	C-value; tolerance; rated voltage; manufacturer's type designation; code for dielectric material; manufacturer's emblem; code for factory of origin; year and week of manufacture
Rated DC voltage	160 V <sub>DC</sub> ; 250 V <sub>DC</sub> ; 400 V <sub>DC</sub> ; 630 V <sub>DC</sub>
Rated AC voltage	100 V <sub>AC</sub> ; 160 V <sub>AC</sub> ; 200 V <sub>AC</sub> ; 220 V <sub>AC</sub>
Rated peak-to-peak voltage	280 V; 450 V; 560 V; 620 V
Rated temperature	85 °C
Performance grade	Grade 1 (long life)
Stability grade	160 V versions: grade 2 250 V to 630 V versions; pitch 5 mm to 15 mm: grade 2 250 V to 630 V versions; pitch 22.5 mm and 27.5 mm: grade 1

#### Note

- For more detailed data and test requirements contact [dc-film@vishay.com](mailto:dc-film@vishay.com)

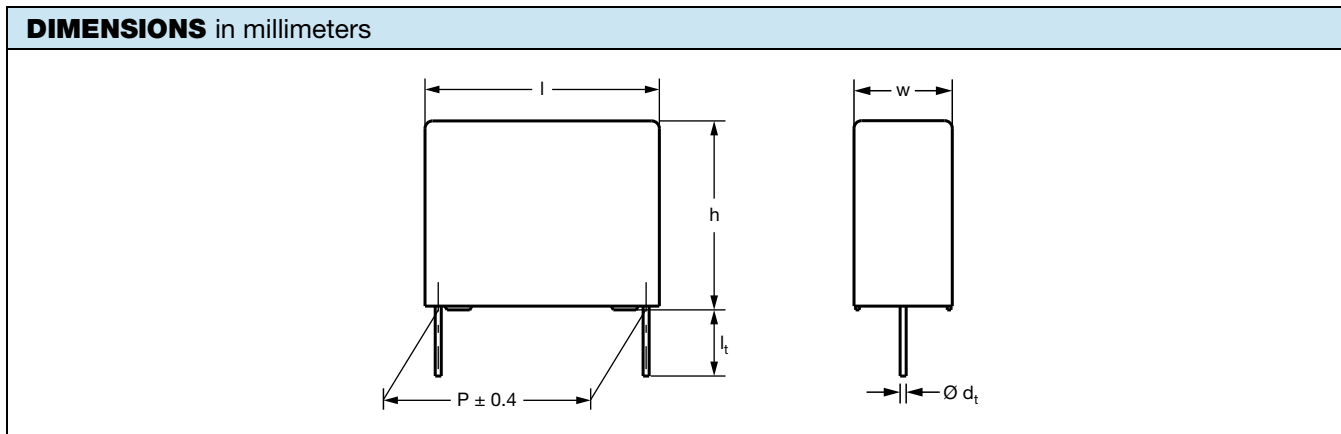

**COMPOSITION OF CATALOG NUMBER**

TYPE AND PITCHES	
379	10.0 mm
	15.0 mm
	22.5 mm
	27.5 mm

**CAPACITANCE**  
(numerically)

MULTIPLIER (nF)	
1	3
10	4
100	5

Example:  
104 = 10 x 10 = 100 nF

2222*	379	XX	XX	X
BFC2	379	XX	XX	X

\* Old ordering code

TYPE	PACKAGING	LEAD CONFIGURATION	PREFERRED TYPES				
			C-TOL.	160 V	250 V	400 V	630 V
379	Loose in box	Lead length 4.0 mm + 1 mm / - 0.5 mm or 3.5 mm ± 0.3 mm	± 5 %	34	44	54	64
TYPE	PACKAGING	LEAD CONFIGURATION	ON REQUEST				
379	Taped on reel	H = 18.5 mm; P <sub>0</sub> = 12.7 mm; reel diameter 500 mm	± 5 %	35	45	55	65



SPECIFIC REFERENCE DATA - 160 V <sub>DC</sub>		
DESCRIPTION	VALUE	
	at 10 kHz	at 100 kHz
Tangent of loss angle:		
$C \leq 0.075 \mu\text{F}$	$\leq 10 \times 10^{-4}$	$\leq 20 \times 10^{-4}$
$0.075 \mu\text{F} < C \leq 0.11 \mu\text{F}$	$\leq 10 \times 10^{-4}$	$\leq 25 \times 10^{-4}$
$0.11 \mu\text{F} < C \leq 0.16 \mu\text{F}$	$\leq 10 \times 10^{-4}$	$\leq 30 \times 10^{-4}$
$0.16 \mu\text{F} < C \leq 0.22 \mu\text{F}$	$\leq 10 \times 10^{-4}$	$\leq 40 \times 10^{-4}$
$0.22 \mu\text{F} < C \leq 0.30 \mu\text{F}$	$\leq 10 \times 10^{-4}$	$\leq 45 \times 10^{-4}$
$0.30 \mu\text{F} < C \leq 0.39 \mu\text{F}$	$\leq 10 \times 10^{-4}$	$\leq 45 \times 10^{-4}$
$0.39 \mu\text{F} < C \leq 0.56 \mu\text{F}$	$\leq 10 \times 10^{-4}$	$\leq 80 \times 10^{-4}$
$0.56 \mu\text{F} < C \leq 0.68 \mu\text{F}$	$\leq 15 \times 10^{-4}$	$\leq 80 \times 10^{-4}$
$0.68 \mu\text{F} < C \leq 0.82 \mu\text{F}$	$\leq 15 \times 10^{-4}$	$\leq 90 \times 10^{-4}$
$0.82 \mu\text{F} < C \leq 0.91 \mu\text{F}$	$\leq 15 \times 10^{-4}$	$\leq 90 \times 10^{-4}$
$0.91 \mu\text{F} < C \leq 1.0 \mu\text{F}$	$\leq 15 \times 10^{-4}$	$\leq 120 \times 10^{-4}$
$1.0 \mu\text{F} < C \leq 1.2 \mu\text{F}$	$\leq 15 \times 10^{-4}$	$\leq 125 \times 10^{-4}$
$1.2 \mu\text{F} < C \leq 1.3 \mu\text{F}$	$\leq 15 \times 10^{-4}$	$\leq 125 \times 10^{-4}$
$1.3 \mu\text{F} < C \leq 1.5 \mu\text{F}$	$\leq 15 \times 10^{-4}$	$\leq 135 \times 10^{-4}$
$1.5 \mu\text{F} < C \leq 1.6 \mu\text{F}$	$\leq 15 \times 10^{-4}$	$\leq 135 \times 10^{-4}$
$1.6 \mu\text{F} < C \leq 1.8 \mu\text{F}$	$\leq 15 \times 10^{-4}$	$\leq 135 \times 10^{-4}$
$1.8 \mu\text{F} < C \leq 2.0 \mu\text{F}$	$\leq 15 \times 10^{-4}$	$\leq 145 \times 10^{-4}$
$2.0 \mu\text{F} < C \leq 2.2 \mu\text{F}$	$\leq 15 \times 10^{-4}$	$\leq 145 \times 10^{-4}$
$2.2 \mu\text{F} < C \leq 2.4 \mu\text{F}$	$\leq 15 \times 10^{-4}$	$\leq 145 \times 10^{-4}$
$2.4 \mu\text{F} < C \leq 2.7 \mu\text{F}$	$\leq 15 \times 10^{-4}$	$\leq 155 \times 10^{-4}$
$2.7 \mu\text{F} < C \leq 3.0 \mu\text{F}$	$\leq 15 \times 10^{-4}$	$\leq 155 \times 10^{-4}$
$3.0 \mu\text{F} < C \leq 3.3 \mu\text{F}$	$\leq 20 \times 10^{-4}$	$\leq 160 \times 10^{-4}$
$3.3 \mu\text{F} < C \leq 3.6 \mu\text{F}$	$\leq 20 \times 10^{-4}$	$\leq 160 \times 10^{-4}$
$3.6 \mu\text{F} < C \leq 3.9 \mu\text{F}$	$\leq 20 \times 10^{-4}$	$\leq 160 \times 10^{-4}$
$3.9 \mu\text{F} < C \leq 4.3 \mu\text{F}$	$\leq 20 \times 10^{-4}$	$\leq 165 \times 10^{-4}$
$4.3 \mu\text{F} < C \leq 4.7 \mu\text{F}$	$\leq 20 \times 10^{-4}$	$\leq 165 \times 10^{-4}$
$4.7 \mu\text{F} < C \leq 5.1 \mu\text{F}$	$\leq 20 \times 10^{-4}$	$\leq 165 \times 10^{-4}$
$5.1 \mu\text{F} < C \leq 5.6 \mu\text{F}$	$\leq 20 \times 10^{-4}$	$\leq 175 \times 10^{-4}$
$5.6 \mu\text{F} < C \leq 6.2 \mu\text{F}$	$\leq 40 \times 10^{-4}$	$\leq 195 \times 10^{-4}$
Rated voltage pulse slope (dU/dt) <sub>R</sub> :		
l = 12.5 mm		60 V/μs
l = 17.5 mm		50 V/μs
l = 26.0 mm		25 V/μs
l = 31.0 mm		15 V/μs (b < 15 mm)
l = 31.0 mm		7.5 V/μs (b ≥ 15 mm)
R between leads for C ≤ 1.0 μF at 100 V; 1 min		> 100 000 MΩ
RC between leads, for C > 1 μF at 100 V; 1 min		> 100 000 s
R between interconnected leads and case; 100 V; 1 min		> 100 000 MΩ
Withstanding (DC) voltage (cut off current 10 mA) <sup>(1)</sup> ; rise time ≤ 1000 V/s		256 V; 1 min
Withstanding (DC) voltage between leads and case		2840 V; 1 min

**Note**

<sup>(1)</sup> See "Voltage Proof Test for Metalized Film Capacitors": [www.vishay.com/doc?28169](http://www.vishay.com/doc?28169)



ELECTRICAL DATA AND ORDERING CODE							
U <sub>RDC</sub> (V)	CAP. ( $\mu$ F)	DIMENSIONS w x h x l (mm)	MASS <sup>(3)</sup> (g)	CATALOG NUMBER BFC2 379 ..... AND PACKAGING			
				LOOSE IN BOX		REEL <sup>(2)</sup>	
				l <sub>t</sub> = 4.0 mm + 1.0 mm / - 0.5 mm <sup>(1)</sup>		H = 18.5 mm, P <sub>0</sub> = 12.7 mm	
				C-TOL. = $\pm$ 5 %	SPQ	SPQ	
LAST 5 DIGITS OF CATALOG NUMBER							
PITCH = 10.0 mm $\pm$ 0.4 mm; d <sub>t</sub> = 0.60 mm $\pm$ 0.06 mm; U <sub>RAC</sub> = 100 V; U <sub>p-p</sub> = 280 V							
160	0.075	4.0 x 10.0 x 12.5	0.60	34753	1000	1400	
	0.082			34823			
	0.091			34913			
	0.10			34104			
	0.11			34114			
	0.12	34124	1100				
	0.13	34134					
	0.15	34154					
	0.16	5.0 x 11.0 x 12.5	0.82	34164	1000	900	
	PITCH = 15.0 mm $\pm$ 0.4 mm; d <sub>t</sub> = 0.60 mm $\pm$ 0.06 mm; U <sub>RAC</sub> = 100 V; U <sub>p-p</sub> = 280 V						
	160	0.18	5.0 x 11.0 x 17.5	1.0	34184	1000	1100
		0.20			34204		
		0.22			34224		
		0.24			34244		
		0.27			34274		
		0.30	34304	900			
0.33		6.0 x 12.0 x 17.5	1.4	34334	1000	900	
0.36				34364			
0.39	34394						
0.43	34434						
0.47	34474	800					
PITCH = 15.0 mm $\pm$ 0.4 mm; d <sub>t</sub> = 0.80 mm $\pm$ 0.08 mm; U <sub>RAC</sub> = 100 V; U <sub>p-p</sub> = 280 V							
160	0.51	7.0 x 13.5 x 17.5	1.8	34514	1000	800	
	0.56			34564		650	
	0.62			34624			
	0.68	8.5 x 15.0 x 17.5	2.4	34684	1000	650	
0.75	34754						
PITCH = 22.5 mm $\pm$ 0.4 mm; d <sub>t</sub> = 0.80 mm $\pm$ 0.08 mm; U <sub>RAC</sub> = 100 V; U <sub>p-p</sub> = 280 V							
160	0.82	6.0 x 15.5 x 26.0	2.4	34824	200	550	
	0.91			34914			
	1.0	7.0 x 16.5 x 26.0	2.9	34105	200	450	
	1.1			34115			
	1.2			34125			
	1.3	8.5 x 18.0 x 26.0	3.8	34135	200	450	
	1.5			34155		350	
	1.6			34165			
	1.8			34185			
	PITCH = 27.5 mm $\pm$ 0.4 mm; d <sub>t</sub> = 0.80 mm $\pm$ 0.08 mm; U <sub>RAC</sub> = 100 V; U <sub>p-p</sub> = 280 V						
160	2.0	9.0 x 19.0 x 31.5	5.5	34205	100		
	2.2			34225			
	2.4	11.0 x 21.0 x 31.0	7.4	34245	100		
	2.7			34275			
	3.0			34305			
	3.3			34335			
	3.6	13.0 x 23.0 x 31.0	9.2	34365	100		
	3.9			34395			
	4.3			34435			
	4.7	15.0 x 25.0 x 31.5	12.3	34475	100		
5.1	34515						
5.6	34565						
6.2	18.0 x 28.0 x 31.5	16.1	34625	100			

## Notes

- SPQ = Standard Packing Quantity
- (1) l<sub>t</sub> = 4.0 mm + 1 mm / - 0.5 mm for pitch = 10 mm and 3.5 mm  $\pm$  0.3 mm for pitch = 15 mm; 22.5 mm and 27.5 mm.
- (2) H = in-tape height; P<sub>0</sub> = sprocket hole distance; for detailed specifications refer to packaging information: [www.vishay.com/doc?28139](http://www.vishay.com/doc?28139)
- (3) Weight for short lead product only



SPECIFIC REFERENCE DATA - 250 V <sub>DC</sub>		
DESCRIPTION	VALUE	
	at 10 kHz	at 100 kHz
Tangent of loss angle:		
0.047 $\mu\text{F} < C \leq 0.075 \mu\text{F}$	$\leq 5 \times 10^{-4}$	$\leq 20 \times 10^{-4}$
0.075 $\mu\text{F} < C \leq 0.011 \mu\text{F}$	$\leq 5 \times 10^{-4}$	$\leq 25 \times 10^{-4}$
0.11 $\mu\text{F} < C \leq 0.18 \mu\text{F}$	$\leq 10 \times 10^{-4}$	$\leq 30 \times 10^{-4}$
0.18 $\mu\text{F} < C \leq 0.3 \mu\text{F}$	$\leq 10 \times 10^{-4}$	$\leq 40 \times 10^{-4}$
0.30 $\mu\text{F} < C \leq 0.39 \mu\text{F}$	$\leq 10 \times 10^{-4}$	$\leq 45 \times 10^{-4}$
0.39 $\mu\text{F} < C \leq 0.56 \mu\text{F}$	$\leq 15 \times 10^{-4}$	$\leq 80 \times 10^{-4}$
0.56 $\mu\text{F} < C \leq 0.68 \mu\text{F}$	$\leq 15 \times 10^{-4}$	$\leq 80 \times 10^{-4}$
0.68 $\mu\text{F} < C \leq 0.82 \mu\text{F}$	$\leq 15 \times 10^{-4}$	$\leq 80 \times 10^{-4}$
0.82 $\mu\text{F} < C \leq 0.91 \mu\text{F}$	$\leq 15 \times 10^{-4}$	$\leq 90 \times 10^{-4}$
0.91 $\mu\text{F} < C \leq 1.0 \mu\text{F}$	$\leq 15 \times 10^{-4}$	$\leq 90 \times 10^{-4}$
1.0 $\mu\text{F} < C \leq 1.2 \mu\text{F}$	$\leq 15 \times 10^{-4}$	$\leq 120 \times 10^{-4}$
1.2 $\mu\text{F} < C \leq 1.3 \mu\text{F}$	$\leq 15 \times 10^{-4}$	$\leq 125 \times 10^{-4}$
1.3 $\mu\text{F} < C \leq 1.5 \mu\text{F}$	$\leq 15 \times 10^{-4}$	$\leq 135 \times 10^{-4}$
1.5 $\mu\text{F} < C \leq 1.6 \mu\text{F}$	$\leq 15 \times 10^{-4}$	$\leq 135 \times 10^{-4}$
1.6 $\mu\text{F} < C \leq 1.8 \mu\text{F}$	$\leq 15 \times 10^{-4}$	$\leq 135 \times 10^{-4}$
1.8 $\mu\text{F} < C \leq 2.0 \mu\text{F}$	$\leq 15 \times 10^{-4}$	$\leq 145 \times 10^{-4}$
2.0 $\mu\text{F} < C \leq 2.2 \mu\text{F}$	$\leq 10 \times 10^{-4}$	$\leq 145 \times 10^{-4}$
2.2 $\mu\text{F} < C \leq 2.4 \mu\text{F}$	$\leq 15 \times 10^{-4}$	$\leq 145 \times 10^{-4}$
2.4 $\mu\text{F} < C \leq 2.7 \mu\text{F}$	$\leq 15 \times 10^{-4}$	$\leq 155 \times 10^{-4}$
2.7 $\mu\text{F} < C \leq 3.0 \mu\text{F}$	$\leq 15 \times 10^{-4}$	$\leq 155 \times 10^{-4}$
3.0 $\mu\text{F} < C \leq 3.3 \mu\text{F}$	$\leq 20 \times 10^{-4}$	$\leq 160 \times 10^{-4}$
3.3 $\mu\text{F} < C \leq 3.6 \mu\text{F}$	$\leq 20 \times 10^{-4}$	$\leq 160 \times 10^{-4}$
3.6 $\mu\text{F} < C \leq 3.9 \mu\text{F}$	$\leq 20 \times 10^{-4}$	$\leq 160 \times 10^{-4}$
Rated voltage pulse slope (dU/dt) <sub>R</sub> :		
l = 12.5 mm		70 V/ $\mu\text{s}$
l = 17.5 mm		60 V/ $\mu\text{s}$
l = 26.0 mm		30 V/ $\mu\text{s}$
l = 31.0 mm		20 V/ $\mu\text{s}$ (b < 15 mm)
l = 31.0 mm		10 V/ $\mu\text{s}$ (b $\geq$ 15 mm)
R between leads for C $\leq$ 1.0 $\mu\text{F}$ at 100 V; 1 min		> 100 000 M $\Omega$
RC between leads, for C > 1 $\mu\text{F}$ at 100 V; 1 min		> 100 000 s
R between interconnected leads and case; 100 V; 1 min		> 100 000 M $\Omega$
Withstanding (DC) voltage (cut off current 10 mA) <sup>(1)</sup> ; rise time 1000 V/s		400 V; 1 min
Withstanding (DC) voltage between leads and case		2840 V; 1 min

**Note**

<sup>(1)</sup> See "Voltage Proof Test for Metalized Film Capacitors": [www.vishay.com/doc?28169](http://www.vishay.com/doc?28169)



ELECTRICAL DATA AND ORDERING CODE						
U <sub>RDC</sub> (V)	CAP. ( $\mu$ F)	DIMENSIONS w x h x l (mm)	MASS <sup>(3)</sup> (g)	CATALOG NUMBER BFC2 379 ..... AND PACKAGING		
				LOOSE IN BOX		REEL <sup>(2)</sup>
				l <sub>t</sub> = 4.0 mm + 1.0 mm/- 0.5 mm <sup>(1)</sup>		H = 18.5 mm, P <sub>0</sub> = 12.7 mm
				C-TOL. = $\pm$ 5 %	SPQ	SPQ
LAST 5 DIGITS OF CATALOG NUMBER						
250	PITCH = 10.0 mm $\pm$ 0.4 mm; d <sub>t</sub> = 0.60 mm $\pm$ 0.06 mm; U <sub>RAC</sub> = 160 V; U <sub>p-p</sub> = 450 V					
	0.047	4.0 x 10.0 x 12.5	0.60	44473	1000	1400
	0.051			44513		
	0.056			44563		
	0.062			44623		
	0.068			44683		
	0.075			44753		
	0.082	44823	1100			
	0.091	44913				
	PITCH = 15.0 mm $\pm$ 0.4 mm; d <sub>t</sub> = 0.60 mm $\pm$ 0.06 mm; U <sub>RAC</sub> = 160 V; U <sub>p-p</sub> = 450 V					
	0.10	5.0 x 11.0 x 17.5	1.0	44104	1000	1100
	0.11			44114		
	0.12			44124		
	0.13			44134		
	0.15			44154		
	0.16			44164		
	0.18	44184	900			
	0.20	44204				
	0.22	44224				
	0.24	44244				
	0.27	6.0 x 12.0 x 17.5	1.4	44274	1000	800
	0.30			44304		
	0.33			44334		
	0.36			44364		
	PITCH = 15.0 mm $\pm$ 0.4 mm; d <sub>t</sub> = 0.80 mm $\pm$ 0.08 mm; U <sub>RAC</sub> = 160 V; U <sub>p-p</sub> = 450 V					
	0.39	7.0 x 13.5 x 17.5	1.8	44394	1000	650
	0.43			44434		
	0.47			44474		
	PITCH = 22.5 mm $\pm$ 0.4 mm; d <sub>t</sub> = 0.80 mm $\pm$ 0.08 mm; U <sub>RAC</sub> = 160 V; U <sub>p-p</sub> = 450 V					
	0.51	6.0 x 15.5 x 26.0	2.4	44514	200	550
	0.56			44564		
	0.62			44624		
	0.68	44684	450			
	0.75	7.0 x 16.5 x 26.0		2.9	44754	
	0.82				44824	
	0.91		44914			
1.0	44105	350				
1.1	44115					
1.2	44125					
PITCH = 27.5 mm $\pm$ 0.4 mm; d <sub>t</sub> = 0.80 mm $\pm$ 0.08 mm; U <sub>RAC</sub> = 160 V; U <sub>p-p</sub> = 450 V						
1.3	9.0 x 19.0 x 31.5	5.5	44135	100		
1.5			44155			
1.6			44165			
1.8			44185			
2.0	11.0 x 21.0 x 31.0	7.4	44205	100		
2.2			44225			
2.4			44245			
2.7			44275			
3.0			44305			
3.3	13.0 x 23.0 x 31.0	9.2	44335	100		
3.6	44365					
3.9	15.0 x 25.0 x 31.5		44395			

**Notes**

- SPQ = Standard Packing Quantity

(1) l<sub>t</sub> = 4.0 mm + 1 mm / - 0.5 mm for pitch = 10 mm and 3.5 mm  $\pm$  0.3 mm for pitch = 15 mm; 22.5 mm and 27.5 mm.

(2) H = in-tape height; P<sub>0</sub> = sprocket hole distance; for detailed specifications refer to packaging information: [www.vishay.com/doc?28139](http://www.vishay.com/doc?28139)

(3) Weight for short lead product only



SPECIFIC REFERENCE DATA - 400 V <sub>DC</sub>		
DESCRIPTION	VALUE	
	at 10 kHz	at 100 kHz
Tangent of loss angle:		
0.022 $\mu\text{F} < C \leq 0.027 \mu\text{F}$	$\leq 10 \times 10^{-4}$	$\leq 15 \times 10^{-4}$
0.027 $\mu\text{F} < C \leq 0.075 \mu\text{F}$	$\leq 10 \times 10^{-4}$	$\leq 20 \times 10^{-4}$
0.075 $\mu\text{F} < C \leq 0.11 \mu\text{F}$	$\leq 10 \times 10^{-4}$	$\leq 25 \times 10^{-4}$
0.11 $\mu\text{F} < C \leq 0.18 \mu\text{F}$	$\leq 10 \times 10^{-4}$	$\leq 30 \times 10^{-4}$
0.18 $\mu\text{F} < C \leq 0.3 \mu\text{F}$	$\leq 10 \times 10^{-4}$	$\leq 40 \times 10^{-4}$
0.30 $\mu\text{F} < C \leq 0.39 \mu\text{F}$	$\leq 10 \times 10^{-4}$	$\leq 45 \times 10^{-4}$
0.39 $\mu\text{F} < C \leq 0.56 \mu\text{F}$	$\leq 15 \times 10^{-4}$	$\leq 80 \times 10^{-4}$
0.56 $\mu\text{F} < C \leq 0.68 \mu\text{F}$	$\leq 15 \times 10^{-4}$	$\leq 80 \times 10^{-4}$
0.68 $\mu\text{F} < C \leq 0.82 \mu\text{F}$	$\leq 15 \times 10^{-4}$	$\leq 80 \times 10^{-4}$
0.82 $\mu\text{F} < C \leq 0.91 \mu\text{F}$	$\leq 15 \times 10^{-4}$	$\leq 90 \times 10^{-4}$
0.91 $\mu\text{F} < C \leq 1.0 \mu\text{F}$	$\leq 15 \times 10^{-4}$	$\leq 90 \times 10^{-4}$
1.0 $\mu\text{F} < C \leq 1.2 \mu\text{F}$	$\leq 15 \times 10^{-4}$	$\leq 120 \times 10^{-4}$
1.2 $\mu\text{F} < C \leq 1.3 \mu\text{F}$	$\leq 15 \times 10^{-4}$	$\leq 125 \times 10^{-4}$
1.3 $\mu\text{F} < C \leq 1.5 \mu\text{F}$	$\leq 15 \times 10^{-4}$	$\leq 135 \times 10^{-4}$
1.5 $\mu\text{F} < C \leq 1.6 \mu\text{F}$	$\leq 15 \times 10^{-4}$	$\leq 135 \times 10^{-4}$
1.6 $\mu\text{F} < C \leq 1.8 \mu\text{F}$	$\leq 15 \times 10^{-4}$	$\leq 135 \times 10^{-4}$
1.8 $\mu\text{F} < C \leq 2.0 \mu\text{F}$	$\leq 15 \times 10^{-4}$	$\leq 145 \times 10^{-4}$
Rated voltage pulse slope (dU/dt) <sub>R</sub> :		
l = 12.5 mm		80 V/ $\mu\text{s}$
l = 17.5 mm		70 V/ $\mu\text{s}$
l = 26.0 mm		35 V/ $\mu\text{s}$
l = 31.0 mm		25 V/ $\mu\text{s}$ (b < 15 mm)
l = 31.0 mm		13 V/ $\mu\text{s}$ (b $\geq$ 15 mm)
R between leads for C $\leq$ 1.0 $\mu\text{F}$ at 100 V; 1 min		> 100 000 M $\Omega$
RC between leads, for C > 1 $\mu\text{F}$ at 100 V; 1 min		> 100 000 s
R between interconnected leads and case; 100 V; 1 min		> 100 000 M $\Omega$
Withstanding (DC) voltage (cut off current 10 mA) <sup>(1)</sup> ; rise time 1000 V/s		640 V; 1 min
Withstanding (DC) voltage between leads and case		2840 V; 1 min

**Note**

<sup>(1)</sup> See "Voltage Proof Test for Metalized Film Capacitors": [www.vishay.com/doc?28169](http://www.vishay.com/doc?28169)



ELECTRICAL DATA AND ORDERING CODE						
U <sub>RDC</sub> (V)	CAP. (μF)	DIMENSIONS w x h x l (mm)	MASS <sup>(3)</sup> (g)	CATALOG NUMBER BFC2 379 ..... AND PACKAGING		
				LOOSE IN BOX		REEL <sup>(2)</sup>
				l <sub>t</sub> = 4.0 mm + 1.0 mm/- 0.5 mm <sup>(1)</sup>		H = 18.5 mm, P <sub>0</sub> = 12.7 mm
				C-TOL. = ± 5 %	SPQ	SPQ
LAST 5 DIGITS OF CATALOG NUMBER						
400	PITCH = 10.0 mm ± 0.4 mm; d <sub>t</sub> = 0.60 mm ± 0.06 mm; U <sub>RAC</sub> = 200 V; U <sub>p-p</sub> = 560 V					
	0.022	4.0 x 10.0 x 12.5	0.60	54223	1000	1400
	0.024			54243		
	0.027			54273		
	0.030			54303		
	0.033			54333		
	0.036			54363		
	0.039	54393	1100			
	0.043	54433				
	PITCH = 15.0 mm ± 0.4 mm; d <sub>t</sub> = 0.60 mm ± 0.06 mm; U <sub>RAC</sub> = 200 V; U <sub>p-p</sub> = 560 V					
	0.047	5.0 x 11.0 x 17.5	1.0	54473	1000	1100
	0.051			54513		
	0.056			54563		
	0.062			54623		
	0.068			54683		
	0.075			54753		
	0.082	54823	900			
	0.091	54913				
	0.10	54104				
	0.11	54114				
	0.12	54124	800			
	0.13	54134				
	0.15	54154				
	0.16	54164	650			
	0.18	54184				
	PITCH = 15.0 mm ± 0.4 mm; d <sub>t</sub> = 0.80 mm ± 0.08 mm; U <sub>RAC</sub> = 200 V; U <sub>p-p</sub> = 560 V					
	0.20	7.0 x 13.5 x 17.5	1.8	54204	1000	650
	0.22			54224		
	PITCH = 22.5 mm ± 0.4 mm; d <sub>t</sub> = 0.80 mm ± 0.08 mm; U <sub>RAC</sub> = 200 V; U <sub>p-p</sub> = 560 V					
	0.24	6.0 x 15.5 x 26.0	2.4	54244	200	550
	0.27			54274		
	0.30			54304		
	0.33	54334	2.9	200	450	
	0.36	54364				
	0.39	54394				
	0.43	54434				
	0.47	54474				
	0.51	8.5 x 18.0 x 26.0	3.8	54514	200	350
	0.56			54564		
	0.62			54624		
PITCH = 27.5 mm ± 0.4 mm; d <sub>t</sub> = 0.80 mm ± 0.08 mm; U <sub>RAC</sub> = 200 V; U <sub>p-p</sub> = 560 V						
0.68	9.0 x 19.0 x 31.5	5.5	54684	100		
0.75			54754			
0.82			54824			
0.91	11.0 x 21.0 x 31.0	7.4	54914	100		
1.0			54105			
1.1			54115			
1.2			54125			
1.3			54135			
1.5	13.0 x 23.0 x 31.0	9.2	54155	100		
1.6			54165			
1.8			54185			
2.0	15.0 x 25.0 x 31.5	12.3	54205	100		

**Notes**

- SPQ = Standard Packing Quantity

(1) l<sub>t</sub> = 4.0 mm + 1 mm / - 0.5 mm for pitch = 10 mm and 3.5 mm ± 0.3 mm for pitch = 15 mm; 22.5 mm and 27.5 mm.

(2) H = in-tape height; P<sub>0</sub> = sprocket hole distance; for detailed specifications refer to packaging information: [www.vishay.com/doc?28139](http://www.vishay.com/doc?28139)

(3) Weight for short lead product only





SPECIFIC REFERENCE DATA - 630 V <sub>DC</sub>		
DESCRIPTION	VALUE	
	at 10 kHz	at 100 kHz
Tangent of loss angle:		
0.010 $\mu\text{F} < C \leq 0.027 \mu\text{F}$	$\leq 10 \times 10^{-4}$	$\leq 15 \times 10^{-4}$
0.027 $\mu\text{F} < C \leq 0.075 \mu\text{F}$	$\leq 10 \times 10^{-4}$	$\leq 20 \times 10^{-4}$
0.075 $\mu\text{F} < C \leq 0.11 \mu\text{F}$	$\leq 10 \times 10^{-4}$	$\leq 25 \times 10^{-4}$
0.11 $\mu\text{F} < C \leq 0.18 \mu\text{F}$	$\leq 10 \times 10^{-4}$	$\leq 30 \times 10^{-4}$
0.18 $\mu\text{F} < C \leq 0.30 \mu\text{F}$	$\leq 10 \times 10^{-4}$	$\leq 40 \times 10^{-4}$
0.30 $\mu\text{F} < C \leq 0.39 \mu\text{F}$	$\leq 10 \times 10^{-4}$	$\leq 40 \times 10^{-4}$
0.39 $\mu\text{F} < C \leq 0.56 \mu\text{F}$	$\leq 10 \times 10^{-4}$	$\leq 45 \times 10^{-4}$
0.56 $\mu\text{F} < C \leq 0.68 \mu\text{F}$	$\leq 15 \times 10^{-4}$	$\leq 80 \times 10^{-4}$
0.68 $\mu\text{F} < C \leq 0.82 \mu\text{F}$	$\leq 15 \times 10^{-4}$	$\leq 80 \times 10^{-4}$
0.82 $\mu\text{F} < C \leq 1.0 \mu\text{F}$	$\leq 15 \times 10^{-4}$	$\leq 90 \times 10^{-4}$
Rated voltage pulse slope (dU/dt) <sub>R</sub> :		
l = 12.5 mm		100 V/ $\mu\text{s}$
l = 17.5 mm		90 V/ $\mu\text{s}$
l = 26.0 mm		45 V/ $\mu\text{s}$
l = 31.0 mm		30 V/ $\mu\text{s}$ (b < 15 mm)
l = 31.0 mm		15 V/ $\mu\text{s}$ (b $\geq$ 15 mm)
R between leads for C $\leq$ 1.0 $\mu\text{F}$ at 500 V; 1 min		> 100 000 M $\Omega$
RC between leads, for C > 1 $\mu\text{F}$ at 100 V; 1 min		> 100 000 s
R between interconnected leads and case; 500 V; 1 min		> 100 000 M $\Omega$
Withstanding (DC) voltage (cut off current 10 mA) <sup>(1)</sup> ; rise time 1000 V/s		960 V; 1 min
Withstanding (DC) voltage between leads and case		2840 V; 1 min

**Note**

<sup>(1)</sup> See "Voltage Proof Test for Metalized Film Capacitors": [www.vishay.com/doc?28169](http://www.vishay.com/doc?28169)



ELECTRICAL DATA AND ORDERING CODE							
U <sub>RDC</sub> (V)	CAP. (μF)	DIMENSIONS w x h x l (mm)	MASS <sup>(3)</sup> (g)	CATALOG NUMBER BFC2 379 ..... AND PACKAGING			
				LOOSE IN BOX		REEL <sup>(2)</sup>	
				l <sub>t</sub> = 4.0 mm + 1.0 mm / - 0.5 mm <sup>(1)</sup>		H = 18.5 mm, P <sub>0</sub> = 12.7 mm	
				C-TOL. = ± 5 %	SPQ	SPQ	
LAST 5 DIGITS OF CATALOG NUMBER							
630	PITCH = 10.0 mm ± 0.4 mm; d <sub>t</sub> = 0.60 mm ± 0.06 mm; U <sub>RAC</sub> = 220 V; U <sub>p-p</sub> = 620 V						
	0.010	4.0 x 10.0 x 12.5	0.60	64103	1000	1400	
	0.011			64113			
	0.012			64123			
	0.013			64133			
	0.015			64153			
	0.016			64163			
	0.018	64183	1100				
	0.020	64203					
	0.022	64223					
	0.024	64243					
	PITCH = 15.0 mm ± 0.4 mm; d <sub>t</sub> = 0.60 mm ± 0.06 mm; U <sub>RAC</sub> = 220 V; U <sub>p-p</sub> = 620 V						
	0.027	5.0 x 11.0 x 17.5		1.0	64273	1000	1100
	0.030		64303				
	0.033		64333				
	0.036		64363				
	0.039		64393				
	0.043		64433		900		
	0.047	64473					
	0.051	64513					
	0.056	64563					
	0.062	64623					
	0.068	64683	800				
	0.075	6.0 x 12.0 x 17.5	1.4	64753	1000	800	
	0.082			64823		800	
	0.091			64913		650	
	0.10			64104		650	
	PITCH = 15.0 mm ± 0.4 mm; d <sub>t</sub> = 0.80 mm ± 0.08 mm; U <sub>RAC</sub> = 220 V; U <sub>p-p</sub> = 620 V						
	0.11	7.0 x 13.5 x 17.5	1.8	64114	1000	650	
	PITCH = 22.5 mm ± 0.4 mm; d <sub>t</sub> = 0.80 mm ± 0.08 mm; U <sub>RAC</sub> = 220 V; U <sub>p-p</sub> = 620 V						
0.12	6.0 x 15.5 x 26.0	2.4	64124	200	550		
0.13			64134				
0.15			64154				
0.16			64164				
0.18	64184	450					
0.20	7.0 x 16.5 x 26.0	2.9	64204	200	450		
0.22			64224		350		
0.24			64244		350		
0.27	8.5 x 18.0 x 26.0	3.8	64274	200	350		
0.30			64304				
PITCH = 27.5 mm ± 0.4 mm; d <sub>t</sub> = 0.80 mm ± 0.08 mm; U <sub>RAC</sub> = 220 V; U <sub>p-p</sub> = 620 V							
0.33	9.0 x 19.0 x 31.5	5.5	64334	100	100		
0.36			64364				
0.39			64394				
0.43			64434				
0.47			64474				
0.51			64514				
0.56	11.0 x 21.0 x 31.0	7.4	64564	100	100		
0.62			64624				
0.68			64684				
0.75			64754				
0.82	13.0 x 23.0 x 31.0	9.2	64824	100	100		
0.91			64914				
1.0			64105				

## Notes

- SPQ = Standard Packing Quantity
- U<sub>RAC</sub> = 250 V / U<sub>p-p</sub> = 700 V for C > 0.11 μF.

<sup>(1)</sup> l<sub>t</sub> = 4.0 mm + 1 mm / - 0.5 mm for pitch = 10 mm and 3.5 mm ± 0.3 mm for pitch = 15 mm; 22.5 mm and 27.5 mm.

<sup>(2)</sup> H = in-tape height; P<sub>0</sub> = sprocket hole distance; for detailed specifications refer to packaging information: [www.vishay.com/doc?28139](http://www.vishay.com/doc?28139)

<sup>(3)</sup> Weight for short lead product only



**CAPACITANCE**

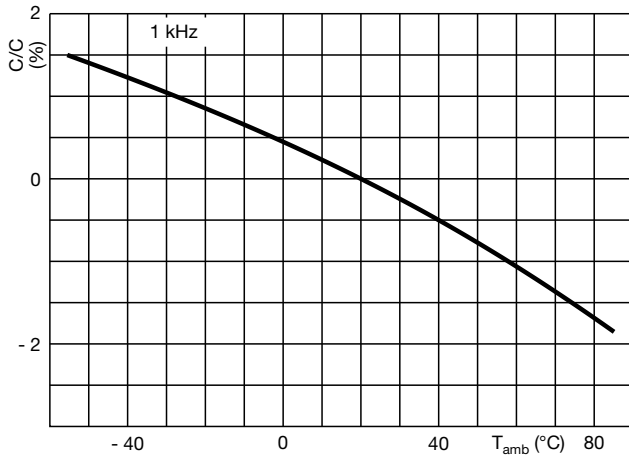

**IMPEDANCE**

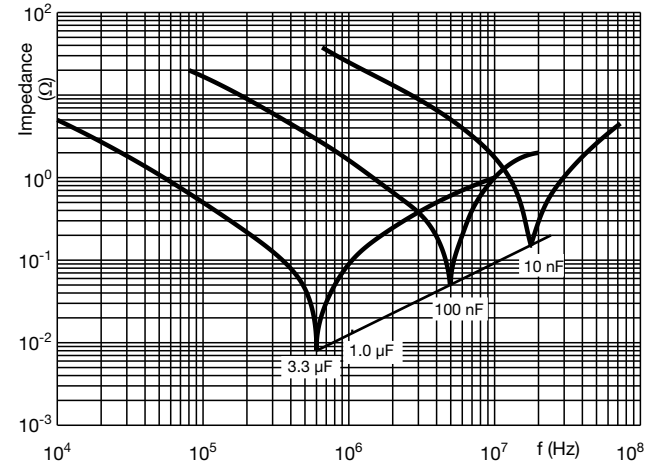

**MAXIMUM RMS VOLTAGE (SINEWAVE) AS A FUNCTION OF FREQUENCY**

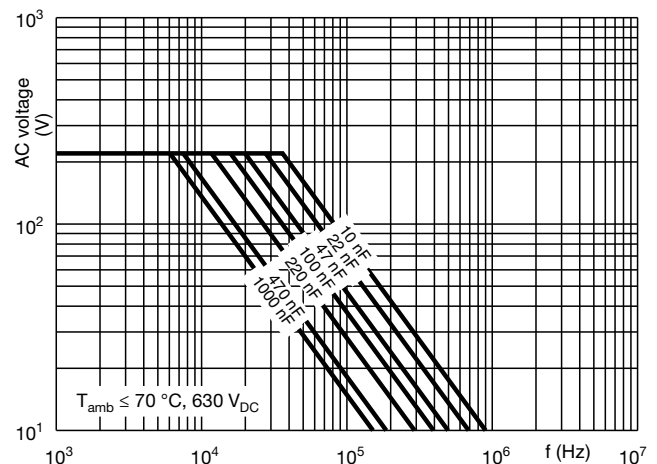
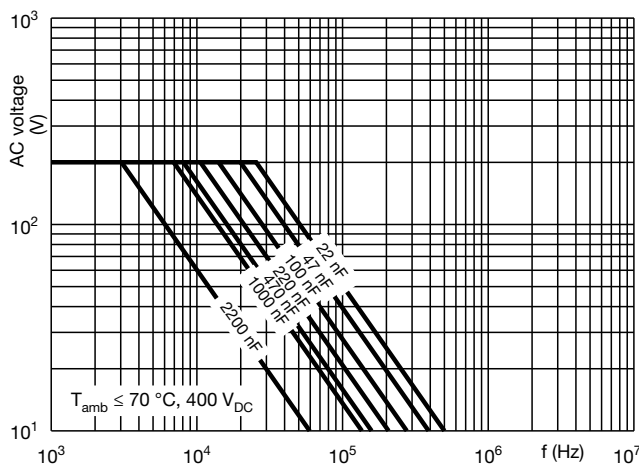
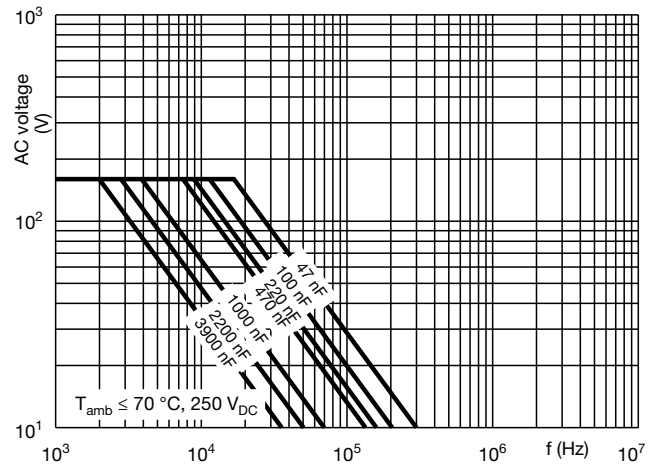
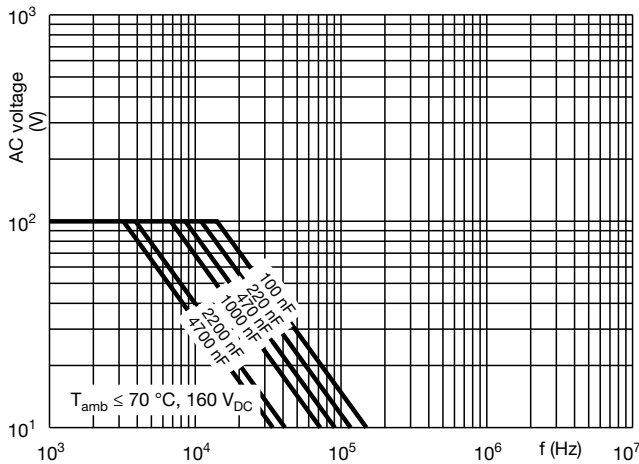



## **Disclaimer**

ALL PRODUCT, PRODUCT SPECIFICATIONS AND DATA ARE SUBJECT TO CHANGE WITHOUT NOTICE TO IMPROVE RELIABILITY, FUNCTION OR DESIGN OR OTHERWISE.

Vishay Intertechnology, Inc., its affiliates, agents, and employees, and all persons acting on its or their behalf (collectively, "Vishay"), disclaim any and all liability for any errors, inaccuracies or incompleteness contained in any datasheet or in any other disclosure relating to any product.

Vishay makes no warranty, representation or guarantee regarding the suitability of the products for any particular purpose or the continuing production of any product. To the maximum extent permitted by applicable law, Vishay disclaims (i) any and all liability arising out of the application or use of any product, (ii) any and all liability, including without limitation special, consequential or incidental damages, and (iii) any and all implied warranties, including warranties of fitness for particular purpose, non-infringement and merchantability.

Statements regarding the suitability of products for certain types of applications are based on Vishay's knowledge of typical requirements that are often placed on Vishay products in generic applications. Such statements are not binding statements about the suitability of products for a particular application. It is the customer's responsibility to validate that a particular product with the properties described in the product specification is suitable for use in a particular application. Parameters provided in datasheets and / or specifications may vary in different applications and performance may vary over time. All operating parameters, including typical parameters, must be validated for each customer application by the customer's technical experts. Product specifications do not expand or otherwise modify Vishay's terms and conditions of purchase, including but not limited to the warranty expressed therein.

Hyperlinks included in this datasheet may direct users to third-party websites. These links are provided as a convenience and for informational purposes only. Inclusion of these hyperlinks does not constitute an endorsement or an approval by Vishay of any of the products, services or opinions of the corporation, organization or individual associated with the third-party website. Vishay disclaims any and all liability and bears no responsibility for the accuracy, legality or content of the third-party website or for that of subsequent links.

Vishay products are not designed for use in life-saving or life-sustaining applications or any application in which the failure of the Vishay product could result in personal injury or death unless specifically qualified in writing by Vishay. Customers using or selling Vishay products not expressly indicated for use in such applications do so at their own risk. Please contact authorized Vishay personnel to obtain written terms and conditions regarding products designed for such applications.

No license, express or implied, by estoppel or otherwise, to any intellectual property rights is granted by this document or by any conduct of Vishay. Product names and markings noted herein may be trademarks of their respective owners.