

| REVISIONS | | | | | |
|-----------|-----|----------------------------|---------|-------|------|
| REV | ECO | DESCRIPTION | DATE | BY | APPR |
| A3 | - | RELEASE NEW DRAWING FORMAT | 02JAN14 | JARRY | - |

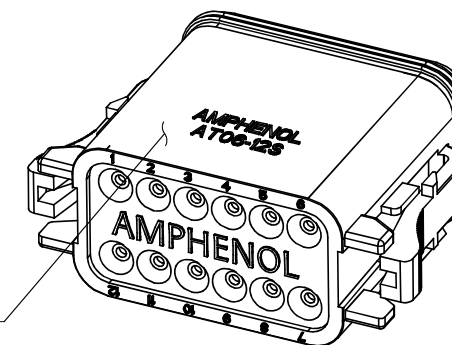

REQUIRES CONTACT RETENTION WEDGE AW12S

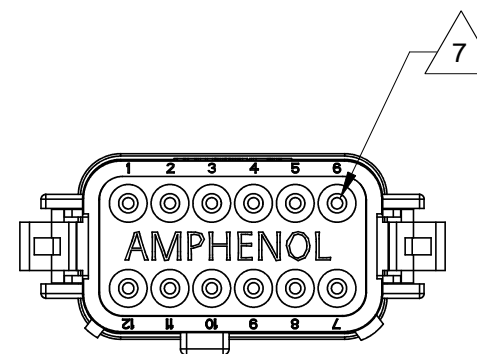
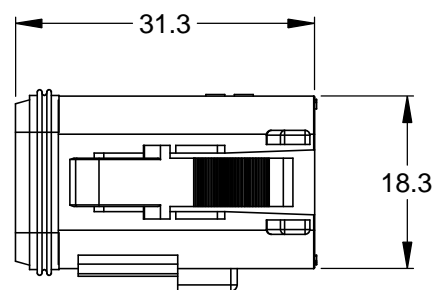
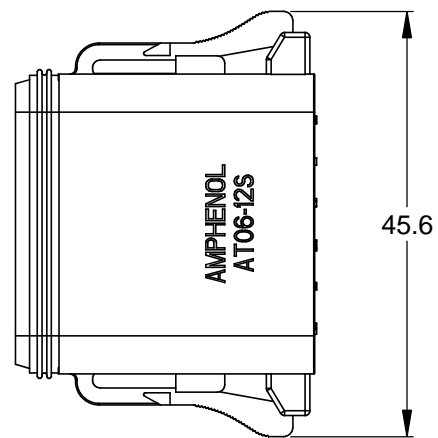
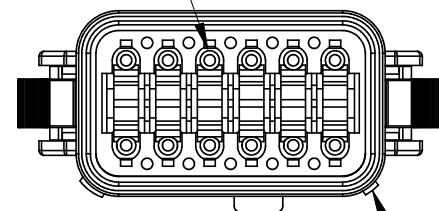

1 KEYWAY (3) PLACES

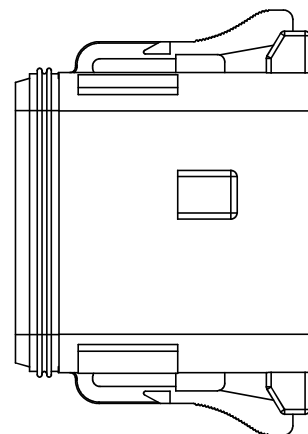

1 REFER TO SHEET 2 FOR AVAILABLE CONNECTOR COLORS

NOTES: UNLESS OTHERWISE SPECIFIED

1 SEE SHEET 2 FOR KEY ARRANGEMENTS AND COLORS.

2. MATERIAL:
HOUSING: THERMOPLASTIC
SEAL: SILICONE RUBBER

3. MODIFICATIONS: N/A

4. SPECIFICATIONS:
4.1 CURRENT RATING: 13 AMPS
4.2 OPERATING TEMPERATURE: -55°C TO +125°C
4.3 DIELECTRIC WITHSTANDING VOLTAGE: LESS THAN 2 MILLIAMPS CURRENT LEAKAGE @ 1500 VOLTS AC.
4.4 INSULATION RESISTANCE: 1000 MEGOHMS MIN @ 25°C.
4.5 MOISTURE RESISTANCE: IP67 (MATED CONDITION)
4.6 MATING CYCLE DURABILITY: 100 CYCLES
4.7 RoHS COMPLIANT

5. MATING PART: AT04-12PX* RECEPTACLE
(X = A,B,C,D KEYS; * = MODIFICATIONS AND COLORS)

6. ALL DIMENSIONS ARE FOR REFERENCE USE ONLY.

7 CONTACT SIZE AND REAR SEAL WIRE RANGE:

| CONTACT SIZE | MIN. INSUL O.D. | MAX. INSUL O.D. | TYPICAL WIRE RANGE |
|--------------|-------------------|-------------------|--------------------|
| 16 | 2.24 mm (.088 in) | 3.68 mm (.145 in) | 14 - 20 AWG |

TITLE: PLUG, 12 SOCKET, AT SERIES, KEYED

DWG NO.: AT06-12SX-XXX

REV: A3

SH: 1

OF: 2

| QUANTITY | SEE SHEET 2 PART NUMBER | DESCRIPTION | ITEM |
|---|--|---|-----------------|
| MATERIALS LIST | | | |
| UNLESS OTHERWISE SPECIFIED 1) All dimensions are in metric(mm). 2) Tolerances are as follows: 1 PL DEC ±0.30 2 PL DEC ±0.15 3 PL DEC ±0.08 Fractions ±1/64 Angles ±1° 3) Note reference = X | | SIGNATURES DRAWN: JARRY CHECKED: ENGINEER: APPROVAL: | DATE 02JAN14 |
| MATERIAL SPECIFICATIONS: | | Amphenol Sine Systems - www.amphenol-sine.com 44724 Morley Drive Clinton Township, MI 48036 | |
| PROCESS SPECIFICATIONS: | | PLUG, 12 SOCKET, AT SERIES, KEYED | |
| NEXT ASSY: | THIS DRAWING IS SUPPLIED FOR INFORMATION ONLY. DESIGN FEATURES, SPECIFICATIONS AND PERFORMANCE DATA SHOWN HEREON ARE THE PROPERTY OF THE AMPHENOL CORPORATION. NO RIGHTS OF REPRODUCTION ARE IMPLIED. ALL DIMENSIONS ARE SUBJECT TO NORMAL MANUFACTURING VARIATIONS. | SCALE: NONE | REVISION A3 |
| | | DWG NO.: AT06-12SX-XXX | SHEET 1 OF 2 |

| REVISIONS | | | | | |
|-----------|-----|-------------|------|----|------|
| REV | ECO | DESCRIPTION | DATE | BY | APPR |

P/N AT06-12SA
KEY-A CONFIGURATION
STANDARD COLOR: GREY

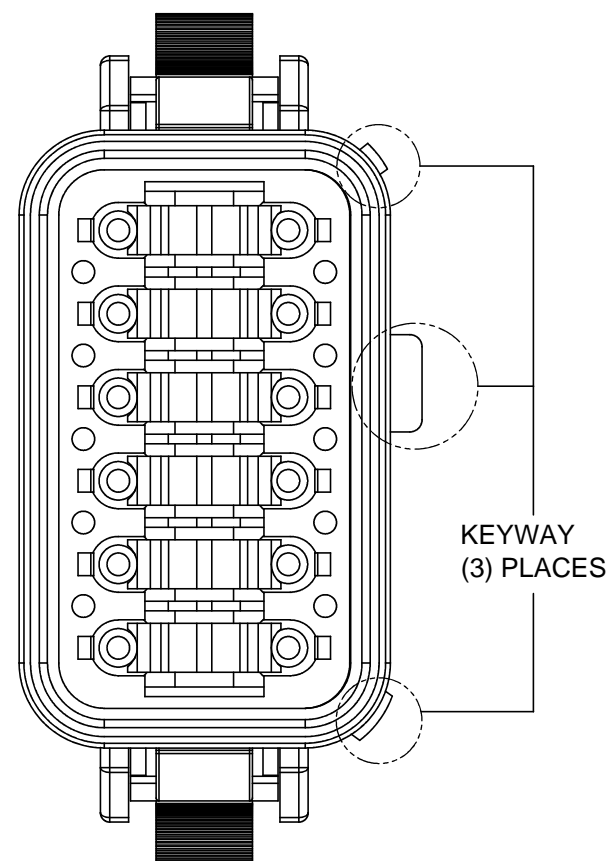

P/N AT06-12SB
KEY-B CONFIGURATION
STANDARD COLOR: BLACK

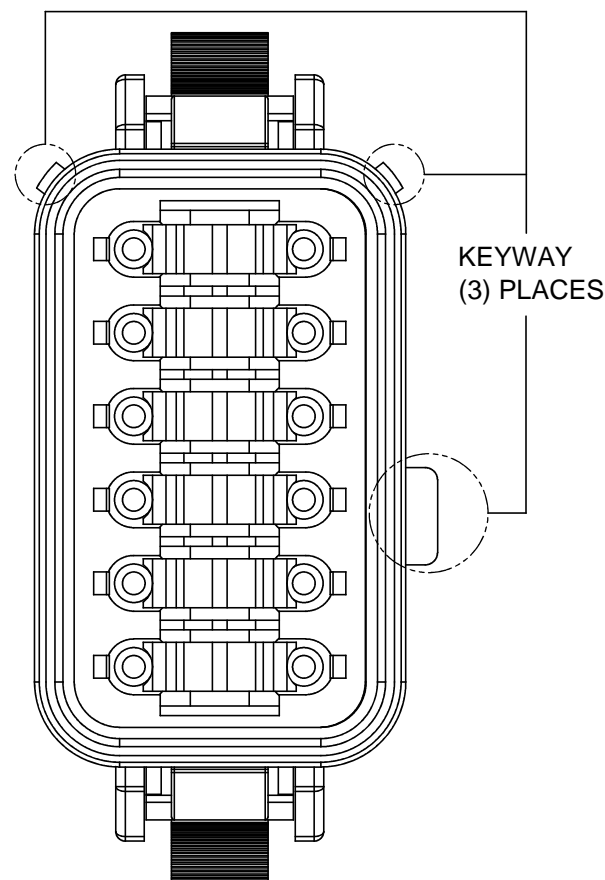

P/N AT06-12SC
KEY-C CONFIGURATION
STANDARD COLOR: GREEN

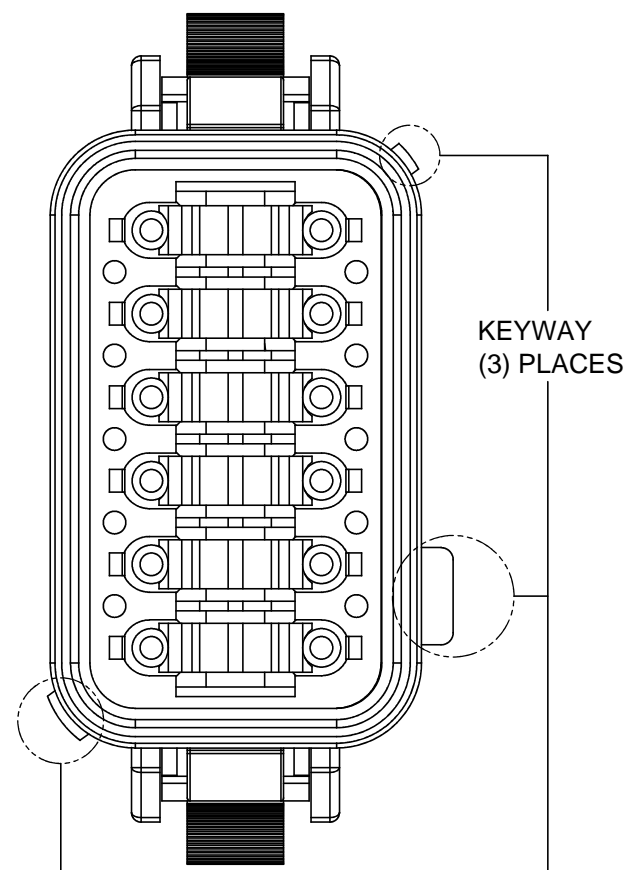

P/N AT06-12SD
KEY-D CONFIGURATION
STANDARD COLOR: BROWN

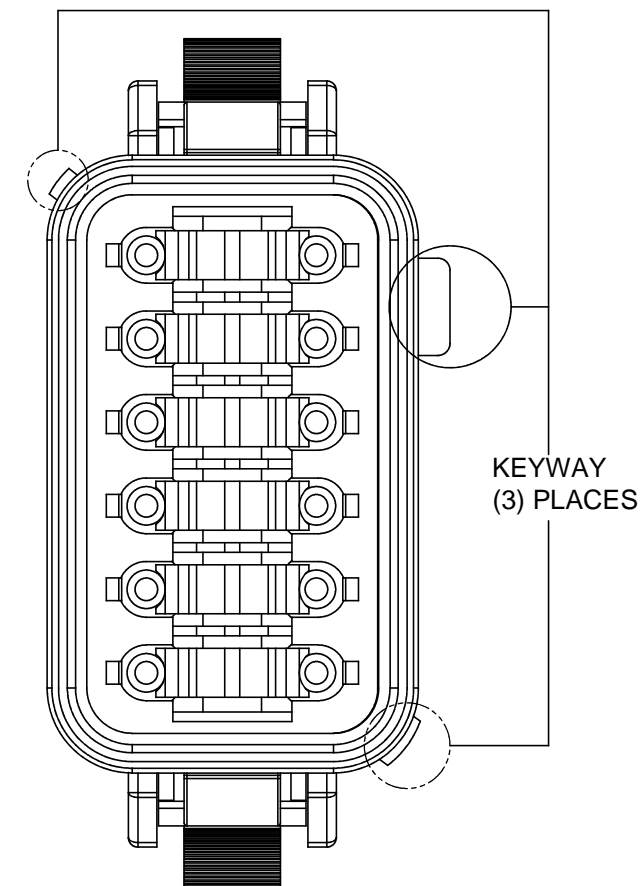

| KEY-A CONFIGURATION | |
|---------------------|---------------|
| COLOR | PART NUMBER |
| * GREY | AT06-12SA |
| BLACK | AT06-12SA-BLK |
| GREEN | AT06-12SA-GRN |
| BROWN | AT06-12SA-BRN |

| KEY-B CONFIGURATION | |
|---------------------|---------------|
| COLOR | PART NUMBER |
| GREY | AT06-12SB-GRY |
| * BLACK | AT06-12SB |
| GREEN | AT06-12SB-GRN |
| BROWN | AT06-12SB-BRN |

| KEY-C CONFIGURATION | |
|---------------------|---------------|
| COLOR | PART NUMBER |
| GREY | AT06-12SC-GRY |
| BLACK | AT06-12SC-BLK |
| * GREEN | AT06-12SC |
| BROWN | AT06-12SC-BRN |

| KEY-D CONFIGURATION | |
|---------------------|---------------|
| COLOR | PART NUMBER |
| GREY | AT06-12SD-GRY |
| BLACK | AT06-12SD-BLK |
| GREEN | AT06-12SD-GRN |
| * BROWN | AT06-12SD |

NOTE:

AN ASTERISKS (*) PLACED BEFORE THE COLOR DENOTES THE STANDARD MOLDED COLOR OF THE CONNECTORS SHOWN ABOVE.

OTHER COLORS SHOWN ARE AVAILABLE VIA SPECIAL ORDER.

TITLE: PLUG, 12 SOCKET, AT SERIES, KEYED
DWG NO.: AT06-12SX-XXX
REV: A3
SH: 2
OF: 2

| QUANTITY | PART NUMBER | DESCRIPTION | ITEM | | | | | | | | | | | | |
|---|-------------|---|----------|------------|------|--------------|----------|----------|----|---------------|----|-----------|------|--------------|--|
| MATERIALS LIST | | | | | | | | | | | | | | | |
| UNLESS OTHERWISE SPECIFIED 1) All dimensions are in metric(mm). 2) Tolerances are as follows: 1 PL DEC ±0.30 2 PL DEC ±0.15 3 PL DEC ±0.08 Fractions ±1/64 Angles ±1° 3) Note reference = | | <table border="1"> <thead> <tr> <th>SIGNATURES</th> <th>DATE</th> </tr> </thead> <tbody> <tr> <td>DRAWN: JARRY</td> <td>02JAN14</td> </tr> <tr> <td>CHECKED:</td> <td></td> </tr> <tr> <td>ENGINEER:</td> <td></td> </tr> <tr> <td>APPROVAL:</td> <td></td> </tr> </tbody> </table> | | SIGNATURES | DATE | DRAWN: JARRY | 02JAN14 | CHECKED: | | ENGINEER: | | APPROVAL: | | | |
| SIGNATURES | DATE | | | | | | | | | | | | | | |
| DRAWN: JARRY | 02JAN14 | | | | | | | | | | | | | | |
| CHECKED: | | | | | | | | | | | | | | | |
| ENGINEER: | | | | | | | | | | | | | | | |
| APPROVAL: | | | | | | | | | | | | | | | |
| MATERIAL SPECIFICATIONS: | | <p style="text-align: center;">Amphenol</p> <p style="text-align: center;">Sine Systems - www.amphenol-sine.com 44724 Morley Drive Clinton Township, MI 48036</p> | | | | | | | | | | | | | |
| PROCESS SPECIFICATIONS: | | <p style="text-align: center;">PLUG, 12 SOCKET, AT SERIES, KEYED</p> | | | | | | | | | | | | | |
| NEXT ASSY: | | <table border="1"> <tr> <td>SIZE</td> <td>TYPE</td> <td>DWG NO.</td> <td>REVISION</td> </tr> <tr> <td>B</td> <td>C-</td> <td>AT06-12SX-XXX</td> <td>A3</td> </tr> <tr> <td>SCALE:</td> <td>NONE</td> <td>SHEET 2 OF 2</td> <td></td> </tr> </table> | | SIZE | TYPE | DWG NO. | REVISION | B | C- | AT06-12SX-XXX | A3 | SCALE: | NONE | SHEET 2 OF 2 | |
| SIZE | TYPE | DWG NO. | REVISION | | | | | | | | | | | | |
| B | C- | AT06-12SX-XXX | A3 | | | | | | | | | | | | |
| SCALE: | NONE | SHEET 2 OF 2 | | | | | | | | | | | | | |

A Series™ - Contact Size 16 Options (Works with: AT, ATV, AHD-9, ARC, DuraMate and PanelMate Series)

| Machined Contacts, Sockets & Pins | | | | |
|-----------------------------------|--|------|-------|----------|
| Part Number | Description | Size | AWG | Type |
| AT60-215-1631 | Male Contact - Pin, Gold-plated | 16 | 14 | Machined |
| AT62-209-1631 | Female Contact - Socket, Gold-plated | 16 | 14 | Machined |
| AT60-215-16141 | Male Contact - Pin, Nickel-plated | 16 | 14 | Machined |
| AT62-209-16141 | Female Contact - Socket, Nickel-plated | 16 | 14 | Machined |
| AT60-202-1631 | Male Contact - Pin, Gold-plated | 16 | 16-20 | Machined |
| AT62-201-1631 | Female Contact - Socket, Gold-plated | 16 | 16-20 | Machined |
| AT60-202-16141 | Male Contact - Pin, Nickel-plated | 16 | 16-20 | Machined |
| AT62-201-16141 | Female Contact - Socket, Nickel-plated | 16 | 16-20 | Machined |
| AT60-202-1631-22 | Male Contact - Pin, Gold-plated | 16 | 22-24 | Machined |
| AT62-201-1631-22 | Female Contact - Socket, Gold-plated | 16 | 22-24 | Machined |
| AT60-202-16141-22 | Male Contact - Pin, Nickel-plated | 16 | 22-24 | Machined |
| AT62-201-16141-22 | Female Contact - Socket, Nickel-plated | 16 | 22-24 | Machined |

| Tooling - Machined Contacts | |
|-----------------------------|---|
| Part Number | Description |
| AUTK-16 | Hand Crimp Tool, Size 16 |
| AUTK-100 | Universal Heavy Duty Contact Crimping Tool Kit, Size 12/16/20 |
| CA-5D12 | Universal Hand Crimp Tool, Size 12/16/20 |
| CA-5E12 | Pneumatic Crimp Tool, Size 12/16/20 |

| Contact Removal Tools (For both Machined or Stamped & Formed Contacts) | |
|--|--|
| Part Number | Description |
| ATRT-100 | Contact and Wedgelock Extraction Tool |
| AT11-310-1605 | Contact Removal Tool, Plastic, Size 16 |

| Sealing Plugs (For both Machined or Stamped & Formed Contacts) | |
|--|---|
| Part Number | Description |
| A114017 | Sealing Plug, Size 16, White |
| A114017-SR | Sealing Plug, Size 16, SR01 Series, Black |
| AT13-217-1605 | Locking Sealing Plug, Size 16, Grey |
| AT13-217-1605-SR | Locking Sealing Plug, Size 16, SR01 Series, Red |

| Stamped & Formed Contacts, Sockets & Pins | | | | |
|---|--|------|-------|------------------|
| Part Number | Description | Size | AWG | Type |
| AT60-14-0122 | Male Contact - Pin, Nickel-plated | 16 | 14-18 | Stamped & Formed |
| AT62-14-0122 | Female Contact - Socket, Nickel-plated | 16 | 14-18 | Stamped & Formed |
| AT60-14-0144 | Male Contact - Pin, Gold-plated | 16 | 14-18 | Stamped & Formed |
| AT62-14-0144 | Female Contact - Socket, Gold-plated | 16 | 14-18 | Stamped & Formed |
| AT60-16-0122 | Male Contact - Pin, Nickel-plated | 16 | 16-18 | Stamped & Formed |
| AT62-16-0122 | Female Contact - Socket, Nickel-plated | 16 | 16-18 | Stamped & Formed |
| AT60-16-0144 | Male Contact - Pin, Gold-plated | 16 | 16-18 | Stamped & Formed |
| AT62-16-0144 | Female Contact - Socket, Gold-plated | 16 | 16-18 | Stamped & Formed |
| AT60-16-0622 | Male Contact - Pin, Nickel-plated | 16 | 16-20 | Stamped & Formed |
| AT62-16-0622 | Female Contact - Socket, Nickel-plated | 16 | 16-20 | Stamped & Formed |
| AT60-16-0644 | Male Contact - Pin, Gold-plated | 16 | 16-20 | Stamped & Formed |
| AT62-16-0644 | Female Contact - Socket, Gold-plated | 16 | 16-20 | Stamped & Formed |
| AT60-16-0677 | Male Contact - Pin, Tin-plated | 16 | 16-20 | Stamped & Formed |
| AT62-16-0677 | Female Contact - Socket, Tin-plated | 16 | 16-20 | Stamped & Formed |
| AT60-16-0822 | Male Contact - Pin, Nickel-plated | 16 | 20-22 | Stamped & Formed |
| AT62-16-0822 | Female Contact - Socket, Nickel-plated | 16 | 20-22 | Stamped & Formed |
| AT60-16-0844 | Male Contact - Pin, Gold-plated | 16 | 20-22 | Stamped & Formed |
| AT62-16-0844 | Female Contact - Socket, Gold-plated | 16 | 20-22 | Stamped & Formed |

| Tooling - Stamped & Formed Contacts | |
|-------------------------------------|-------------------------------------|
| MFX-3950 | Crimp Die - Size 16, 18-20AWG |
| MFX-3953 | Crimp Die - Size 16, 16-18AWG |
| MFX-3975 | Crimp Die - Size 16, 14-16AWG |
| MFX-3990 | Crimp Die - Size 16, 20-22AWG |
| ATT-16-00 | Hand Crimp Tool - Size 16, 14-16AWG |
| ATT-16-01 | Hand Crimp Tool - Size 16, 18-20AWG |
| ATT-1612-03 | Hand Crimp Tool - Size 16, 20-22AWG |