



Interference Suppression Film Capacitors MKP Radial Potted Type



FEATURES

- 15 mm to 27.5 mm lead pitch.
Supplied in box, taped on ammpack or reel
- Material categorization:
for definitions of compliance please see www.vishay.com/doc?99912



**RoHS
COMPLIANT**

APPLICATIONS

X1 class
For X1 electromagnetic interference suppression in across the line applications (50 Hz / 60 Hz) with a maximum mains voltage of 275 V_{AC}.
For application limitations please refer to section "Application Notes".

QUICK REFERENCE DATA	
Capacitance range (E12 series)	0.01 μF to 1 μF (preferred values according to E6)
Capacitance tolerance	± 20 %; ± 10 %; ± 5 %
Rated AC voltage	275 V _{AC} ; 50 Hz to 60 Hz
Permissible DC voltage	630 V _{DC}
Climatic testing class (according to EN 60068-1)	55/105/56/B
Maximum application temperature	105 °C
Rated temperature	105 °C
Leads	Tinned wire
Reference standards	IEC 60384-14:2013 IEC 60384-14:2013 / AMD1:2016 EN 60384-14:2013 + AMD1:2016 IEC 60065, pass. flamm. class B UL 60384-14 CSA E384-14
Dielectric	Polypropylene film
Electrodes	Metallized film
Construction	Mono construction 
Encapsulation	Plastic case, epoxy resin sealed, flame retardant UL-class 94 V-0
Marking	C-value; tolerance; rated voltage; sub-class; manufacturer's type; code for dielectric material; manufacturer location, year and week; manufacturer's logo or name; safety approvals

Note

- For more detailed data and test requirements, contact rfi@vishay.com

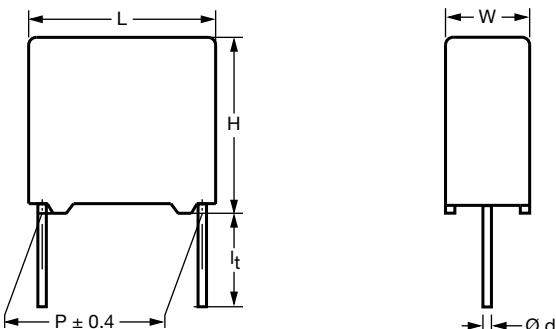
DIMENSIONS in millimeters



COMPOSITION OF CATALOG NUMBER

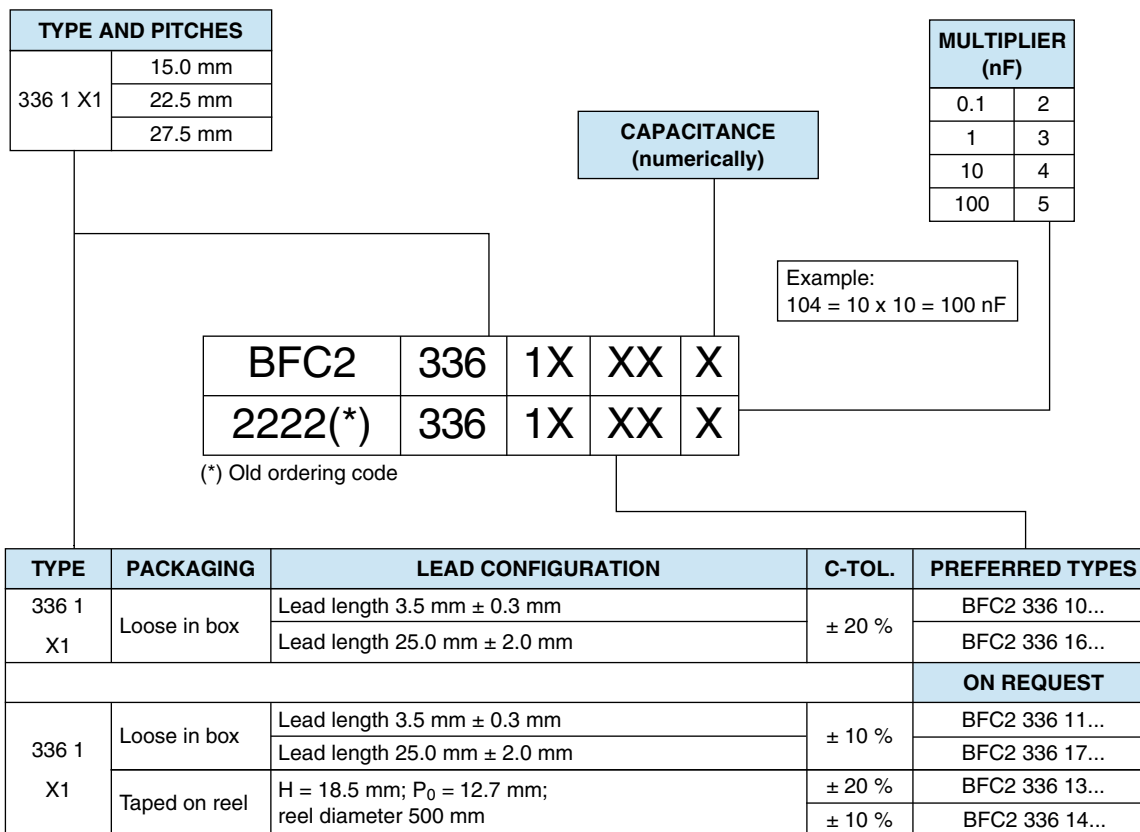

Note

(1) For detailed tape specifications refer to packaging information: www.vishay.com/doc?28139

SPECIFIC REFERENCE DATA	
DESCRIPTION	VALUE
Tangent of loss angle:	at 10 kHz
C ≤ 100 nF	≤ 10 x 10 ⁻⁴
100 nF < C ≤ 470 nF	≤ 20 x 10 ⁻⁴
C > 470 nF	≤ 70 x 10 ⁻⁴
Rated voltage pulse slope (dU/dt) _R at 385 V _{DC} :	
P = 15 mm	250 V/μs
P = 22.5 mm	150 V/μs
P = 27.5 mm	100 V/μs
R between leads, for C ≤ 0.33 μF at 100 V; 1 min	> 15 000 MΩ
RC between leads, for C > 0.33 μF at 100 V; 1 min	> 5000 s
R between leads and case; 100 V; 1 min	> 30 000 MΩ
Withstanding (DC) voltage (cut off current 10 mA) ⁽¹⁾ ; rise time ≤ 1000 V/s	3400 V; 1 min
Withstanding (AC) voltage between leads and case	2050 V; 1 min

Note

(1) See "Voltage Proof Test for Metalized Film Capacitors": www.vishay.com/doc?28169



ELECTRICAL DATA AND ORDERING INFORMATION									
U _{RAC} (V)	CAP. (µF)	DIMENSIONS W x H x L (mm)	MASS (g) ⁽¹⁾	CATALOG NUMBER BFC2 336 1 AND PACKAGING					
				LOOSE IN BOX				REEL 500 mm ⁽¹⁾⁽²⁾	
				l _t = 3.5 mm ± 0.3 mm		l _t = 25.0 mm ± 2.0 mm		H = 18.5 mm; P ₀ = 12.7 mm	
				LAST 5 DIGITS OF CATALOG NUMBER	SPQ	LAST 5 DIGITS OF CATALOG NUMBER	SPQ	LAST 5 DIGITS OF CATALOG NUMBER	SPQ
PITCH = 15.0 mm ± 0.4 mm; d_t = 0.6 mm ± 0.06 mm; U_{RAC} = 275 V; C-TOL. = ± 20 %									
0.010	5.0 x 11.0 x 17.5	17.5	1	19001	1000	19007	1000	19002	1100
0.015				10153		16153		13153	
0.022				10223		16223		13223	
0.033	6.0 x 12.0 x 17.5	17.5	1.4	10333		16333		13333	900
PITCH = 15.0 mm ± 0.4 mm; d_t = 0.8 mm ± 0.08 mm; U_{RAC} = 275 V; C-TOL. = ± 20 %									
0.047	7.0 x 13.5 x 17.5	17.5	1.8	10473	1000	16473	500	13473	800
0.068	8.5 x 15.0 x 17.5	17.5	2.4	10683		16683		13683	650
0.100	10.0 x 16.5 x 17.5	17.5	3	10104	500	16104			13104
PITCH = 22.5 mm ± 0.4 mm; d_t = 0.8 mm ± 0.08 mm; U_{RAC} = 275 V; C-TOL. = ± 20 %									
0.10	7.0 x 16.5 x 26.0	26.0	2.9	19003	200	19008	500	19004	550
0.15	8.5 x 18.0 x 26.0	26.0	3.8	10154		16154		13154	450
0.22	10.0 x 19.5 x 26.0	26.0	6.8	10224		16224		13224	400
PITCH = 27.5 mm ± 0.4 mm; d_t = 0.8 mm ± 0.08 mm; U_{RAC} = 275 V; C-TOL. = ± 20 %									
0.22	11.0 x 21.0 x 31.0	31.0	7.4	19005	100	19009	125		
0.33	13.0 x 23.0 x 31.0	31.0	9.2	10334		16334			
0.47	15.0 x 25.0 x 31.0	31.0	12.3	10474		16474			
0.68	18.0 x 28.0 x 31.0	31.0	16.1	10684		16684			
1.00	21.0 x 31.0 x 31.0	31.0	20.3	10105	50	16105	75		
PITCH = 15.0 mm ± 0.4 mm; d_t = 0.6 mm ± 0.06 mm; U_{RAC} = 275 V; C-TOL. = ± 10 %									
0.010	5.0 x 11.0 x 17.5	17.5	1	11103	1000	17103	1000	14103	1100
0.012				11123		17123		14123	
0.015				11153		17153		14153	
0.018	6.0 x 12.0 x 17.5	17.5	1.4	11183		17183		14183	900
0.022				11223	17223	14223			
0.027				11273	17273	14273			
PITCH = 15.0 mm ± 0.4 mm; d_t = 0.8 mm ± 0.08 mm; U_{RAC} = 275 V; C-TOL. = ± 10 %									
0.033	7.0 x 13.5 x 17.5	17.5	1.8	11333	1000	17333	500	14333	800
0.039				11393		17393		14393	
0.047	8.5 x 15.0 x 17.5	17.5	2.4	11473		17473		14473	650
0.056				11563	17563	14563			
0.068	10.0 x 16.5 x 17.5	17.5	3	11683	500	17683		14683	600
0.082				11823	17823	14823			
PITCH = 22.5 mm ± 0.4 mm; d_t = 0.8 mm ± 0.08 mm; U_{RAC} = 275 V; C-TOL. = ± 10 %									
0.10	7.0 x 16.5 x 26.0	26.0	2.9	11104	200	17104	500	14104	550
0.12	8.5 x 18.0 x 26.0	26.0	3.8	11124		17124	250	14124	450
0.15				11154		17154	14154		
0.18	10.0 x 19.5 x 26.0	26.0	6.8	11184		17184	500	14184	400
PITCH = 27.5 mm ± 0.4 mm; d_t = 0.8 mm ± 0.08 mm; U_{RAC} = 275 V; C-TOL. = ± 10 %									
0.22	11.0 x 21.0 x 31.0	31.0	7.4	11224	100	17224	125		
0.27				11274		17274			
0.33	13.0 x 23.0 x 31.0	31.0	9.2	11334		17334			
0.39	15.0 x 25.0 x 31.0	31.0	12.3	11394		17394			
0.47				11474	17474				
0.56				11564	17564				
0.68	18.0 x 28.0 x 31.0	31.0	16.1	11684		17684		14684	
0.82	21.0 x 31.0 x 31.0	31.0	20.3	11824	50	17824	75		

Notes

- SPQ = Standard Packing Quantity
- (1) Reel diameter = 356 mm is available on request
- (2) H = In tape height; P₀ = Sprocket hole distance; for detailed specifications refer to Packaging Information.
- (3) Weight for short lead product only



APPROVALS				
SAFETY APPROVALS X1	VOLTAGE	VALUE	FILE NUMBERS	LINKS
EN 60384-14 (ENEC) (= IEC 60384-14 ed-4 (2013))	275 V _{AC}	10 nF to 1 µF	ENEC16/FI/21/01061/A2	www.vishay.com/doc?28197
UL 60384-14	275 V _{AC}	10 nF to 1 µF	E354331	www.vishay.com/doc?28188
CSA E384-14	275 V _{AC}	10 nF to 1 µF	E354331	
CB-Test-Certificate	275 V _{AC}	10 nF to 1 µF	FI-39828/A1	www.vishay.com/doc?28198
The ENEC-approval together with the CB-Certificate replace all national marks of the following countries (they have already signed the ENEC-Agreement): Austria; Belgium; Czech. Republic; Denmark; Finland; France; Germany; Greece; Hungary; Ireland; Italy; Luxembourg; Netherlands; Norway; Portugal; Slovenian; Spain; Switzerland and United Kingdom.				

MOUNTING

Normal Use

The capacitors are designed for mounting on printed-circuit boards. The capacitors packed in bandoleers are designed for mounting in printed-circuit boards by means of automatic insertion machines.

For detailed tape specifications refer to “Packaging information”.

Specific Method of Mounting to Withstand Vibration and Shock

In order to withstand vibration and shock tests, it must be ensured that the stand-off pips are in good contact with the printed-circuit board:

- For pitches ≤ 15 mm capacitors shall be mechanically fixed by the leads
- For longer pitches the capacitors shall be mounted in the same way and the body clamped

Space Requirements on Printed Circuit Board

The maximum length and width of film capacitors is shown in Figure:

- Eccentricity as in figure. The maximum eccentricity is smaller than or equal to the lead diameter of the product concerned
- Product height with seating plane as given by “IEC 60717” as reference: $h_{max.} \leq h + 0.3 \text{ mm}$

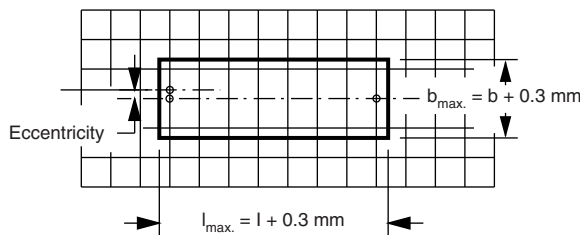

CBA116

SOLDERING CONDITIONS

For general soldering conditions and wave soldering profile, we refer to the application note:

“Soldering Guidelines for Film Capacitors”: www.vishay.com/doc?28171

Storage Temperature

T_{stg} = -25 °C to +35 °C with RH maximum 75 % without condensation

Ratings and Characteristics Reference Conditions

Unless otherwise specified, all electrical values apply to an ambient temperature of 23 °C ± 1 °C, an atmospheric pressure of 86 kPa to 106 kPa and a relative humidity of 50 % ± 2 %.

For reference testing, a conditioning period shall be applied over 96 h ± 4 h by heating the products in a circulating air oven at the rated temperature and a relative humidity not exceeding 20 %.



CHARACTERISTICS

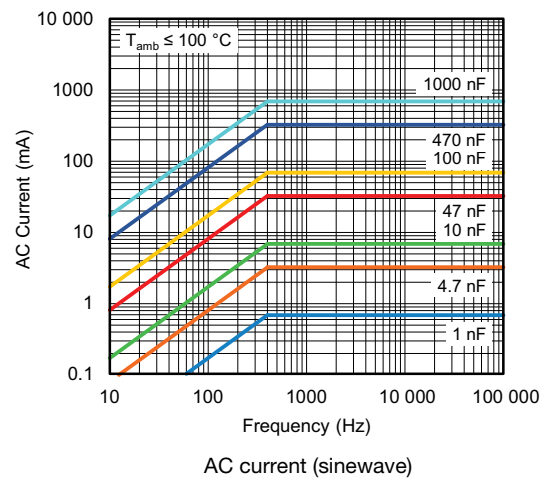
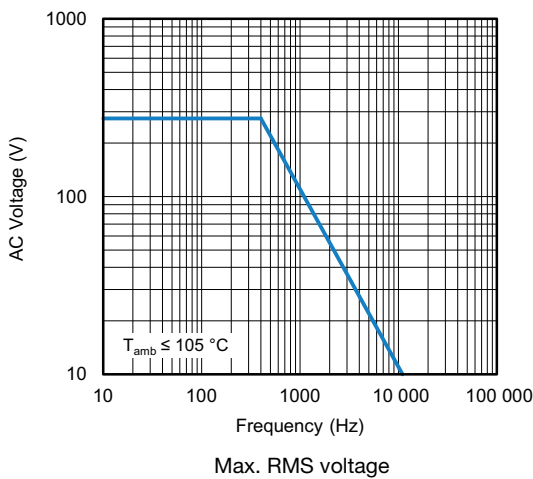
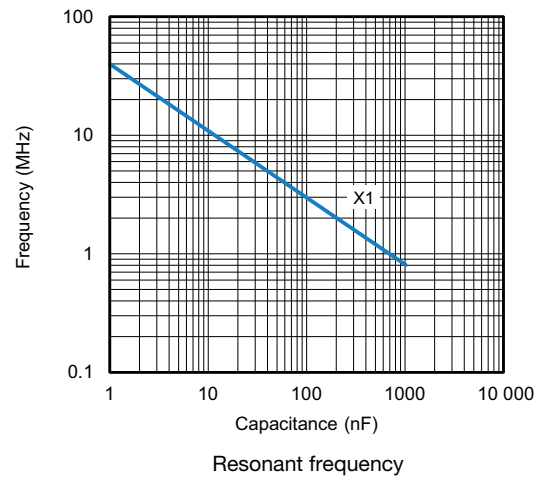
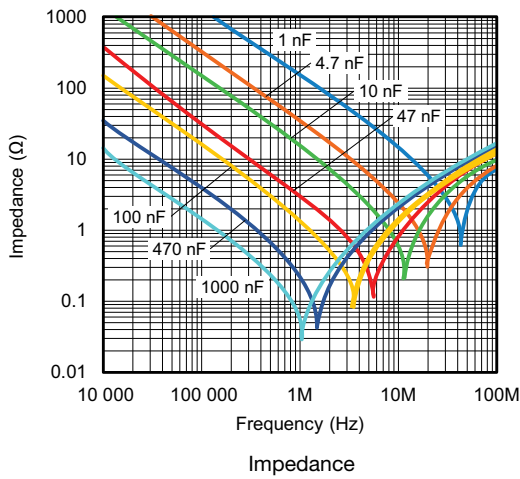
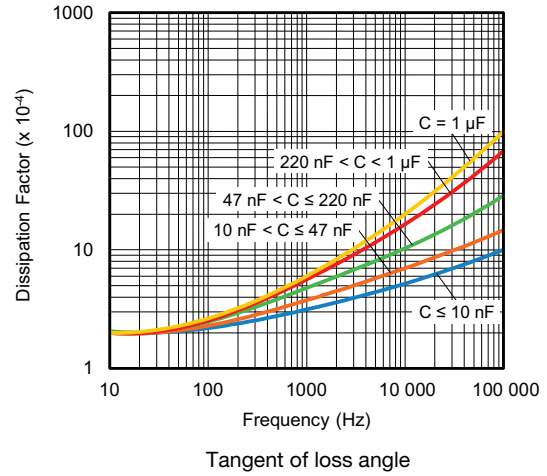
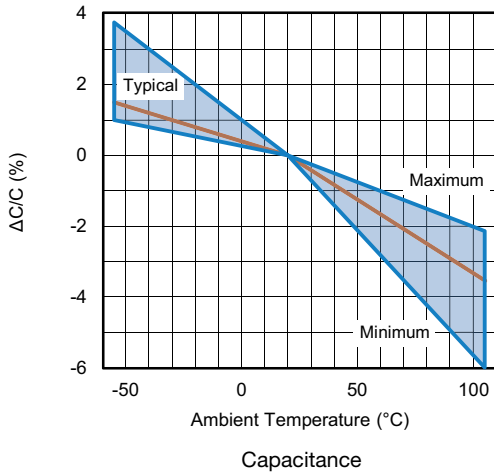

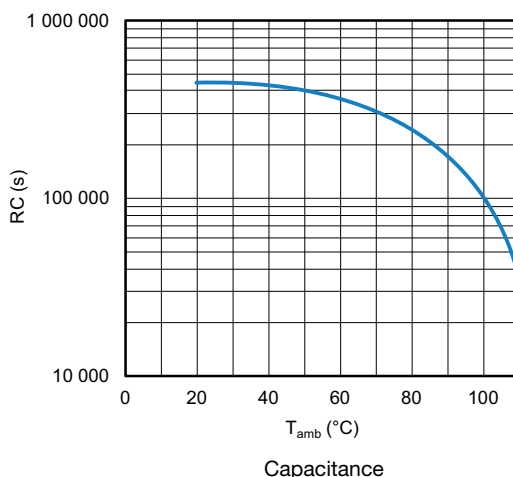

APPLICATION NOTES

- For X2 electromagnetic interference suppression in standard across the line applications (50 Hz / 60 Hz) with a maximum mains voltage of 310 V_{AC}
- For series impedance applications we refer to application note www.vishay.com/doc?28153
- For capacitors connected in parallel, normally the proof voltage and possibly the rated voltage must be reduced. For information depending of the capacitance value and the number of parallel connections contact: dc-film@vishay.com
- These capacitors are not intended for continuous pulse application. For these situations capacitors of the AC and pulse programs must be used
- The maximum ambient temperature must not exceed 110 °C. (125 °C for less than 1000 h) for C ≤ 470 nF and 110 °C for C > 470 nF
- Rated voltage pulse slope:
If the pulse voltage is lower than the rated voltage, the values of the specific reference data can be multiplied by 435 V_{DC} and divided by the applied voltage

INSPECTION REQUIREMENTS

General Notes

Sub-clause numbers of tests and performance requirements refer to the “Sectional Specification, Publication IEC 60384-14 ed-4 (2013) and Specific Reference Data.”

GROUP C INSPECTION REQUIREMENTS			
SUB-CLAUSE NUMBER AND TEST	D OR ND	CONDITIONS	PERFORMANCE REQUIREMENTS
SUB-GROUP C1A PART OF SAMPLE OF SUB-GROUP C1	D		
4.1 Dimensions (detail) Initial measurements		Capacitance Tangent of loss angle: For C ≤ 470 nF at 100 kHz For C > 470 nF at 10 kHz	As specified in chapters “General Data” of this specification
4.3 Robustness of terminations		Tensile: load 10 N; 10 s Bending: load 5 N; 4 x 90°	No visible damage



GROUP C INSPECTION REQUIREMENTS			
SUB-CLAUSE NUMBER AND TEST	D OR ND	CONDITIONS	PERFORMANCE REQUIREMENTS
SUB-GROUP C1A PART OF SAMPLE OF SUB-GROUP C1		D	
4.4 Resistance to soldering heat		No pre-drying Method: 1A Solder bath: 260 °C Duration: 10 s	
4.19 Component solvent resistance		Isopropylalcohol at room temperature Method: 2 Immersion time: 5 min ± 0.5 min Recovery time: Min. 1 h, max. 2 h	
4.4.2 Final measurements		Visual examination	No visible damage Legible marking
		Capacitance	$ \Delta C/C \leq 5\%$ of the value measured initially
		Tangent of loss angle	Increase of $\tan \delta: \leq 0.008$ Compared to values measured initially
		Insulation resistance	As specified in section "Insulation Resistance" of this specification
SUB-GROUP C1B PART OF SAMPLE OF SUB-GROUP C1		D	
Initial measurements		Capacitance Tangent of loss angle: For $C \leq 470$ nF at 100 kHz For $C > 470$ nF at 10 kHz	No visible damage Legible marking
4.20 Solvent resistance of the marking: see section "General Notes"; item 5		Isopropylalcohol at room temperature Method: 1 Rubbing material: cotton wool Immersion time: 5 min ± 0.5 min	No visible damage
4.6 Rapid change of temperature		$\theta A = -55$ °C $\theta B = +105$ °C 5 cycles	
SUB-GROUP C1B PART OF SAMPLE OF SUB-GROUP C1		D	
4.6.1 Inspection		Duration $t = 30$ min	
4.7 Vibration (see note 3.1)		Visual examination Mounting: see section "Mounting" of this specification Procedure B4: Frequency range: 10 Hz to 55 Hz Amplitude: 0.75 mm or Acceleration 98 m/s ² (whichever is less severe) Total duration 6 h	No visible damage
4.7.2 Final inspection		Visual examination	No visible damage



GROUP C INSPECTION REQUIREMENTS			
SUB-CLAUSE NUMBER AND TEST	D OR ND	CONDITIONS	PERFORMANCE REQUIREMENTS
SUB-GROUP C1B PART OF SAMPLE OF SUB-GROUP C1	D		
4.9 Shock (see note 3)		Mounting: See section "Mounting" for more information Pulse shape: Half sine Acceleration: 490 m/s ² Duration of pulse: 11 ms	
4.9.2 Final measurements		Visual examination Capacitance Tangent of loss angle Insulation resistance	No visible damage $ \Delta C/C \leq 5\%$ of the value measured initially Increase of $\tan \delta: \leq 0.008$ Compared to values measured initially As specified in section "Insulation Resistance" of this specification
SUB-GROUP C1 COMBINED SAMPLE OF SPECIMENS OF SUB-GROUPS C1A AND C1B	D		
4.11 Climatic sequence			
4.11.1 Initial measurements		Capacitance Measured in 4.4.2 and 4.9.2 Tangent of loss angle: Measured initially in C1A and C1B	
4.11.2 Dry heat		Temperature: 105 °C Duration: 16 h	
4.11.3 Damp heat cyclic Test Db First cycle			
4.11.4 Cold		Temperature: - 55 °C Duration: 2 h	
4.11.5 Damp heat cyclic Test Db remaining cycles			
SUB-GROUP C1 COMBINED SAMPLE OF SPECIMENS OF SUB-GROUPS C1A AND C1B	D		
4.11.6 Final measurements		Visual examination Capacitance Tangent of loss angle Voltage proof 1200 V _{DC} ; 1 min between term Insulation resistance	No visible damage Legible marking $ \Delta C/C \leq 5\%$ of the value measured in 4.11.1. Increase of $\tan \delta: \leq 0.008$ compared to values measured in 4.11.1 No permanent breakdown or flash-over $\geq 50\%$ of values specified in section "Insulation Resistance" of this specification



GROUP C INSPECTION REQUIREMENTS			
SUB-CLAUSE NUMBER AND TEST	D OR ND	CONDITIONS	PERFORMANCE REQUIREMENTS
SUB-GROUP C2		D	
4.12 Damp heat steady state		56 days, 40 °C, 90 % to 95 % RH, no load capacitance	
4.12.1 Initial measurements		Tangent of loss angle at 10 kHz	
4.12.3 Final measurements		Visual examination	No visible damage Legible marking
		Capacitance	$ \Delta C/C \leq 5\%$ of the value measured in 4.12.1.
		Tangent of loss angle	Increase of $\tan \delta: \leq 0.008$ Compared to values measured in 4.12.1.
		Voltage proof 1200 V _{DC} ; 1 min between term	No permanent breakdown or flash-over
		Insulation resistance	$\geq 50\%$ of values specified in section "Insulation Resistance" of this specification
SUB GROUP C3		D	
4.13.1 Initial measurements		Capacitance Tangent of loss angle: For C ≤ 470 nF at 100 kHz For C > 470 nF at 10 kHz	
4.13 Impulse voltage		3 successive impulses, full wave, peak voltage: X1: 4 kV Max. 24 pulses	No selfhealing breakdowns or flashover
4.14 Endurance		Duration: 1000 h 1.25 U _{RAC} at 105 °C Once in every hour the voltage is increased to 1000 V _{RMS} for 0.1 s via resistor of 47 Ω ± 5 %	
SUB GROUP C3		D	
4.14.7 Final measurements		Visual examination	No visible damage Legible marking
		Capacitance	$ \Delta C/C \leq 10\%$ compared to values measured in 4.13.1.
		Tangent of loss angle	Increase of $\tan \delta: \leq 0.008$ Compared to values measured in 4.13.1.
		Voltage proof 1200 V _{DC} ; 1 min between terminations 2050 V _{DC} ; 1 min between terminations and case	No permanent breakdown or flash-over
		Insulation resistance	$\geq 50\%$ of values specified in section "Insulation Resistance" of this specification



GROUP C INSPECTION REQUIREMENTS			
SUB-CLAUSE NUMBER AND TEST	D OR ND	CONDITIONS	PERFORMANCE REQUIREMENTS
SUB-GROUP C 4		D	
4.15 Charge and discharge		10 000 cycles (50 c/s) charge to U_R half sinewave Duration: 5 ms Discharge resistance:	
		$R = \frac{385 V_{DC}}{1.5 \times C(dU/dt)}$	
		$R_{min.} = 2.2$	
4.15.1 Initial measurements		Capacitance Tangent of loss angle For $C \leq 470$ nF at 100 kHz For $C > 470$ nF at 10 kHz	
4.15.3 Final measurements		Capacitance	$ \Delta C/C \leq 10\%$ compared to values measured in 4.15.1.
		Tangent of loss angle	Increase of $\tan \delta: \leq 0.008$ Compared to values measured in 4.15.1
		Insulation resistance	$\geq 50\%$ of values specified in section "Insulation Resistance" of this specification
SUB-GROUP C5		D	
4.16 Radio frequency characteristic		Resonance frequency	As specified in section "Resonant Frequency" of this specification. $\pm 10\%$
SUB-GROUP C6		D	
4.17 Passive flammability Class B		Bore of gas jet: $\varnothing 0.5$ mm Fuel: Butane Test duration for actual volume V in mm^3 : $V \leq 250$: 10 s $250 < V \leq 500$: 20 s $500 < V \leq 1750$: 30 s $V > 1750$: 60 s One flame application	After removing test flame from capacitor, the capacitor must not continue to burn for more than 10 s. No burning particle must drop from the sample.
SUB-GROUP C7		D	
4.18 Active flammability		20 x 4 kV discharges on the test capacitor connected to U_R	The cheese cloth around the capacitors shall not burn with a flame. No electrical measurements are required.



Disclaimer

ALL PRODUCT, PRODUCT SPECIFICATIONS AND DATA ARE SUBJECT TO CHANGE WITHOUT NOTICE TO IMPROVE RELIABILITY, FUNCTION OR DESIGN OR OTHERWISE.

Vishay Intertechnology, Inc., its affiliates, agents, and employees, and all persons acting on its or their behalf (collectively, "Vishay"), disclaim any and all liability for any errors, inaccuracies or incompleteness contained in any datasheet or in any other disclosure relating to any product.

Vishay makes no warranty, representation or guarantee regarding the suitability of the products for any particular purpose or the continuing production of any product. To the maximum extent permitted by applicable law, Vishay disclaims (i) any and all liability arising out of the application or use of any product, (ii) any and all liability, including without limitation special, consequential or incidental damages, and (iii) any and all implied warranties, including warranties of fitness for particular purpose, non-infringement and merchantability.

Statements regarding the suitability of products for certain types of applications are based on Vishay's knowledge of typical requirements that are often placed on Vishay products in generic applications. Such statements are not binding statements about the suitability of products for a particular application. It is the customer's responsibility to validate that a particular product with the properties described in the product specification is suitable for use in a particular application. Parameters provided in datasheets and / or specifications may vary in different applications and performance may vary over time. All operating parameters, including typical parameters, must be validated for each customer application by the customer's technical experts. Product specifications do not expand or otherwise modify Vishay's terms and conditions of purchase, including but not limited to the warranty expressed therein.

Hyperlinks included in this datasheet may direct users to third-party websites. These links are provided as a convenience and for informational purposes only. Inclusion of these hyperlinks does not constitute an endorsement or an approval by Vishay of any of the products, services or opinions of the corporation, organization or individual associated with the third-party website. Vishay disclaims any and all liability and bears no responsibility for the accuracy, legality or content of the third-party website or for that of subsequent links.

Vishay products are not designed for use in life-saving or life-sustaining applications or any application in which the failure of the Vishay product could result in personal injury or death unless specifically qualified in writing by Vishay. Customers using or selling Vishay products not expressly indicated for use in such applications do so at their own risk. Please contact authorized Vishay personnel to obtain written terms and conditions regarding products designed for such applications.

No license, express or implied, by estoppel or otherwise, to any intellectual property rights is granted by this document or by any conduct of Vishay. Product names and markings noted herein may be trademarks of their respective owners.