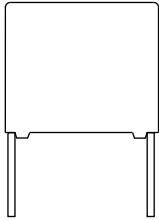

Interference Suppression Film Capacitors MKP Radial Potted Type

FEATURES

- AEC-Q200 qualified (rev. C) up to 110 °C
- THB: 40 °C / 93 % RH for 1000 h at rated voltage, in compliance with AEC-Q200
- Compliant with IEC 60384-14: AMD1 grade IA
- High temperature capabilities, up to 125 °C
- Material categorization: for definitions of compliance please see www.vishay.com/doc?99912

 AUTOMOTIVE
GRADE

RoHS
COMPLIANT

APPLICATIONS

For standard across the line X2 applications.

 See also application note: www.vishay.com/doc?28153

| QUICK REFERENCE DATA | |
|--------------------------------------|--|
| Rated capacitance range (E12 series) | 0.001 μ F to 4.7 μ F (preferred values acc. to E6) |
| Capacitance tolerance | $\pm 20\%$; $\pm 10\%$; $\pm 5\%$ |
| Rated voltage range, U_{RAC} | 310 V_{AC} ; 50 Hz to 60 Hz |
| Permissible DC voltage | 800 V_{DC} at 85 °C 630 V_{DC} at 110 °C |
| Climatic testing class | 55/110/56/C for product volumes $\leq 1750 \text{ mm}^3$ 55/110/56/B for product volumes $> 1750 \text{ mm}^3$ |
| Rated temperature | 110 °C |
| Maximum application temperature | 125 °C for limited time |
| Reference standards | IEC 60384-14:2013 IEC 60384-14:2013 / AMD1:2016 EN 60384-14:2013 + AMD1:2016 IEC 60065 requires pass. flamm. class B for volumes $> 1750 \text{ mm}^3$ UL 60384-14 CSA-E384-14 CQC |
| Dielectric | Polypropylene film |
| Electrodes | Metallized |
| Construction | Mono construction  |
| Encapsulation | Plastic case, epoxy resin sealed, flame retardant UL-class 94 V-0 |
| Leads | Tinned wire |
| Marking | C-value; tolerance; rated voltage; sub-class; manufacturer's type; code for dielectric material, manufacturer location; manufacturer's logo; year and week; safety approvals |

Note

- For more detailed data and test requirements, contact rfi@vishay.com

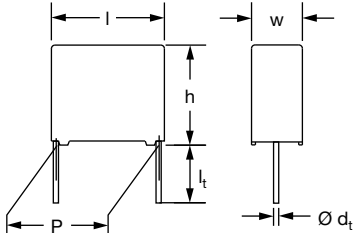
| DIMENSIONS in millimeters |
|---|
|  |



COMPOSITION OF CATALOG NUMBER



| TYPE | PACKAGING | STANDARD DIMENSIONS | C-TOL. | CODE NUMBER | | | |
|-------------------------|--|--|----------------|---------------------------------------|----------------|---------------|--------------------|
| 339 X2 | Loose in box | Lead length 3.5 mm + 1 mm/- 0.5 mm or 3.5 mm ± 0.3 mm | ± 20 % | BFC2 339 20... | | | |
| | | Lead length 5.0 mm ± 1.0 mm | | BFC2 339 22... | | | |
| | | Lead length 25.0 mm ± 2.0 mm | | BFC2 339 24... | | | |
| | Taped ⁽¹⁾ | Reel: H = 18.5 mm; P ₀ = 12.7 mm or 15.0 mm | | BFC2 339 26... | | | |
| | | Ammopack: H = 18.5 mm; P ₀ = 12.7 mm | | BFC2 339 28... | | | |
| | Loose in box | Lead length 3.5 mm + 1 mm/- 0.5 mm or 3.5 mm ± 0.3 mm | | ± 10 % | BFC2 339 10... | | |
| | | Lead length 5.0 mm ± 1.0 mm | | | BFC2 339 12... | | |
| | | Lead length 25.0 mm ± 2.0 mm | | | BFC2 339 14... | | |
| | Taped ⁽¹⁾ | Reel: H = 18.5 mm; P ₀ = 12.7 mm or 15.0 mm | | | BFC2 339 16... | | |
| | | Ammopack: H = 18.5 mm; P ₀ = 12.7 mm | BFC2 339 18... | | | | |
| | Loose in box | Lead length 3.5 mm + 1 mm/- 0.5 mm or 3.5 mm ± 0.3 mm | ± 5 % | | BFC2 339 50... | | |
| | | Lead length 5.0 mm ± 1.0 mm | | | BFC2 339 52... | | |
| | | Lead length 25.0 mm ± 2.0 mm | | | BFC2 339 54... | | |
| | Taped ⁽¹⁾ | Reel: H = 18.5 mm; P ₀ = 12.7 mm or 15.0 mm | | | BFC2 339 36... | | |
| | | Ammopack: H = 18.5 mm; P ₀ = 12.7 mm | | BFC2 339 38... | | | |
| | PACKAGING | | | ALTERNATIVE LARGER PITCH SIZES | | C-TOL. | CODE NUMBER |
| | Loose in box | Lead length 3.5 mm + 1 mm/- 0.5 mm or 3.5 mm ± 0.3 mm | | ± 20 % | BFC2 339 21... | | |
| | | Lead length 5.0 mm ± 1.0 mm | | | BFC2 339 23... | | |
| | | Lead length 25.0 mm ± 2.0 mm | | | BFC2 339 25... | | |
| | Taped ⁽¹⁾⁽²⁾ | Reel or ammpack: H = 18.5 mm; P ₀ = 12.7 mm | BFC2 339 27... | | | | |
| Loose in box | Lead length 3.5 mm + 1 mm/- 0.5 mm or 3.5 mm ± 0.3 mm | ± 10 % | BFC2 339 11... | | | | |
| | Lead length 5.0 mm ± 1.0 mm | | BFC2 339 13... | | | | |
| | Lead length 25.0 mm ± 2.0 mm | | BFC2 339 15... | | | | |
| Taped ⁽¹⁾⁽²⁾ | Reel or ammpack: H = 18.5 mm; P ₀ = 12.7 mm | | BFC2 339 17... | | | | |
| Loose in box | Lead length 3.5 mm + 1 mm/- 0.5 mm or 3.5 mm ± 0.3 mm | | ± 5 % | | BFC2 339 51... | | |
| | Lead length 5.0 mm ± 1.0 mm | | | BFC2 339 53... | | | |
| | Lead length 25.0 mm ± 2.0 mm | | | BFC2 339 55... | | | |
| Taped ⁽¹⁾⁽²⁾ | Reel: H = 18.5 mm; P ₀ = 12.7 mm or 15.0 mm | | | BFC2 339 46... | | | |
| | Ammopack: H = 18.5 mm; P ₀ = 12.7 mm | | | BFC2 339 48... | | | |

Notes

- (1) For detailed tape specification refer to "Packaging Information": www.vishay.com/doc?28139
- (2) Taped on reel pitch = 27.5 mm is not available



| SPECIFIC REFERENCE DATA | | |
|---|--------------------------|--------------------------|
| DESCRIPTION | VALUE | |
| Rated AC voltage (U_{RAC}) | 310 V | |
| Permissible DC voltage (U_{RDC}) | 630 V | |
| Tangent of loss angle: | at 1 kHz | at 10 kHz |
| $C < 470$ nF | $\leq 10 \times 10^{-4}$ | $\leq 20 \times 10^{-4}$ |
| 470 nF $\leq C \leq 1$ μ F | $\leq 20 \times 10^{-4}$ | $\leq 70 \times 10^{-4}$ |
| $C > 1$ μ F | $\leq 30 \times 10^{-4}$ | - |
| Rated voltage pulse slope (dU/dt) _R at 435 V _{DC} : | | |
| Pitch = 7.5 mm | 600 V/ μ s | |
| Pitch = 10 mm | 600 V/ μ s | |
| Pitch = 15 mm | 400 V/ μ s | |
| Pitch = 22.5 mm | 150 V/ μ s | |
| Pitch = 27.5 mm | 100 V/ μ s | |
| R between leads, for $C \leq 0.33$ μ F at 100 V; 1 min | $> 15\ 000$ M Ω | |
| RC between leads, for $C > 0.33$ μ F at 100 V; 1 min | > 5000 s | |
| R between leads and case; 100 V; 1 min | $> 30\ 000$ M Ω | |
| Withstanding (DC) voltage (cut off current 10 mA) ⁽¹⁾ ; rise time ≤ 1000 V/s: | | |
| $C \leq 1$ μ F | 2200 V; 1 min | |
| $C > 1$ μ F | 1800 V; 1 min | |
| Withstanding (AC) voltage between leads and case | 2120 V; 1 min | |
| Max. application temperature for 0.001 μ F $\leq C \leq 0.47$ μ F | 125 °C up to 1000 h | |
| Max. application temperature for $C > 0.47$ μ F | 125 °C up to 500 h | |

Note

⁽¹⁾ See "Voltage Proof Test for Metalized Film Capacitors": www.vishay.com/doc?28169

| ELECTRICAL DATA AND ORDERING INFORMATION - PITCH: 7.5 mm | | | | | | | | | | |
|---|--------------------|--|----------------------------|---|--------------------------------|-------|---------------------------------|-------|---|------|
| U_{RAC} (V) | CAP. (μ F) | DIMENSIONS ⁽¹⁾ w x h x l (mm) | MASS (g) ⁽²⁾ | CATALOG NUMBER BFC2 339 XXXXX AND PACKAGING | | | | | | |
| | | | | LOOSE IN BOX | | | | | AMMOPACK ⁽³⁾ | |
| | | | | SHORT LEADS | | | LONG LEADS | | H = 18.5 mm P ₀ = 12.7 mm | |
| | | | | $l_t = 3.5$ mm + 1 mm/- 0.5 mm | $l_t = 5.0$ mm ± 1.0 mm | SPQ | $l_t = 25.0$ mm ± 2.0 mm | SPQ | | SPQ |
| PITCH = 7.5 mm \pm 0.4 mm; $d_t = 0.50$ mm \pm 0.05 mm; C-TOL. = ± 20 % | | | | | | | | | | |
| 310 | 0.0010 | 4.0 x 9.0 x 10.0 | 0.4 | 20102 | 22102 | 1500 | 24102 | 1000 | 28102 | 1250 |
| | 0.0015 | | | 20152 | 22152 | | 24152 | | 28152 | |
| | 0.0022 | | | 20222 | 22222 | | 24222 | | 28222 | |
| | 0.0033 | | | 20332 | 22332 | | 24332 | | 28332 | |
| | 0.0047 | | | 20472 | 22472 | | 24472 | | 28472 | |
| | 0.0068 | | | 20682 | 22682 | | 24682 | | 28682 | |
| | 0.010 | | | 20103 | 22103 | | 24103 | | 28103 | |
| | 0.015 | | | 20153 | 22153 | | 24153 | | 28153 | |
| | 0.022 | | | 20223 | 22223 | | 24223 | | 28223 | |
| | 0.033 | | | 20333 | 22333 | | 24333 | | 28333 | |
| | 0.047 | 5.0 x 10.5 x 10.0 | 0.4 | 20473 | 22473 | 1000 | 24473 | 1250 | 28473 | 1000 |
| 0.068 | 6.0 x 11.5 x 10.0 | 0.8 | 20683 | 22683 | 750 | 24683 | 1000 | 28683 | 750 | |



| ELECTRICAL DATA AND ORDERING INFORMATION - PITCH: 7.5 mm | | | | | | | | | | | |
|--|--|---|----------------------------|---|--|-------|---|-------|---|-------|------|
| U _{RAC} (V) | CAP. (µF) | DIMENSIONS ⁽¹⁾ w x h x l (mm) | MASS (g) ⁽²⁾ | CATALOG NUMBER BFC2 339 XXXXX AND PACKAGING | | | | | | | |
| | | | | LOOSE IN BOX | | | | | AMMOPACK ⁽³⁾ | | |
| | | | | SHORT LEADS | | | LONG LEADS | | H = 18.5 mm P ₀ = 12.7 mm | | |
| | | | | <i>l</i> _t = 3.5 mm + 1 mm/- 0.5 mm | <i>l</i> _t = 5.0 mm ± 1.0 mm | SPQ | <i>l</i> _t = 25.0 mm ± 2.0 mm | SPQ | | SPQ | |
| 310 | PITCH = 7.5 mm ± 0.4 mm; d _t = 0.50 mm ± 0.05 mm; C-TOL. = ± 10 % | | | | | | | | | | |
| | 0.0010 | 4.0 x 9.0 x 10.0 | 0.45 | 10102 | 12102 | 1500 | 14102 | 1000 | 18102 | 1250 | |
| | 0.0012 | | | 10122 | 12122 | | 14122 | | 18122 | | |
| | 0.0015 | | | 10152 | 12152 | | 14152 | | 18152 | | |
| | 0.0018 | | | 10182 | 12182 | | 14182 | | 18182 | | |
| | 0.0022 | | | 10222 | 12222 | | 14222 | | 18222 | | |
| | 0.0027 | | | 10272 | 12272 | | 14272 | | 18272 | | |
| | 0.0033 | | | 10332 | 12332 | | 14332 | | 18332 | | |
| | 0.0039 | | | 10392 | 12392 | | 14392 | | 18392 | | |
| | 0.0047 | | | 10472 | 12472 | | 14472 | | 18472 | | |
| | 0.0056 | | | 10562 | 12562 | | 14562 | | 18562 | | |
| | 0.0068 | | | 10682 | 12682 | | 14682 | | 18682 | | |
| | 0.0082 | | | 10822 | 12822 | | 14822 | | 18822 | | |
| | 0.010 | | | 10103 | 12103 | | 14103 | | 18103 | | |
| | 0.012 | | | 10123 | 12123 | | 14123 | | 18123 | | |
| | 0.015 | | | 10153 | 12153 | | 14153 | | 18153 | | |
| | 0.018 | | | 10183 | 12183 | | 14183 | | 18183 | | |
| | 0.022 | | | 10223 | 12223 | | 14223 | | 18223 | | |
| | 0.027 | 10273 | 12273 | 14273 | 18273 | | | | | | |
| | 0.033 | 5.0 x 10.5 x 10.0 | 0.6 | 10333 | 12333 | 1000 | 14333 | 1250 | 18333 | 1000 | |
| | 0.039 | | | 10393 | 12393 | | 14393 | | 18393 | | |
| | 0.047 | | | 10473 | 12473 | | 14473 | | 18473 | | |
| | 0.056 | 6.0 x 11.5 x 10.0 | 0.8 | 10563 | 12563 | 750 | 14563 | 1000 | 18563 | 750 | |
| | 310 | PITCH = 7.5 mm ± 0.4 mm; d _t = 0.50 mm ± 0.05 mm; C-TOL. = ± 5 % | | | | | | | | | |
| | | 0.0010 | 4.0 x 9.0 x 10.0 | 0.45 | 50102 | 52102 | 1500 | 54102 | 1000 | 38102 | 1250 |
| | | 0.0012 | | | 50122 | 52122 | | 54122 | | 38122 | |
| | | 0.0015 | | | 50152 | 52152 | | 54152 | | 38152 | |
| | | 0.0018 | | | 50182 | 52182 | | 54182 | | 38182 | |
| | | 0.0022 | | | 50222 | 52222 | | 54222 | | 38222 | |
| | | 0.0027 | | | 50272 | 52272 | | 54272 | | 38272 | |
| | | 0.0033 | | | 50332 | 52332 | | 54332 | | 38332 | |
| | | 0.0039 | | | 50392 | 52392 | | 54392 | | 38392 | |
| | | 0.0047 | | | 50472 | 52472 | | 54472 | | 38472 | |
| | | 0.0056 | | | 50562 | 52562 | | 54562 | | 38562 | |
| | | 0.0068 | | | 50682 | 52682 | | 54682 | | 38682 | |
| | | 0.0082 | | | 50822 | 52822 | | 54822 | | 38822 | |
| 0.010 | | 50103 | | | 52103 | 54103 | | 38103 | | | |
| 0.012 | | 50123 | | | 52123 | 54123 | | 38123 | | | |
| 0.015 | | 50153 | | | 52153 | 54153 | | 38153 | | | |
| 0.018 | | 50183 | | | 52183 | 54183 | | 38183 | | | |
| 0.022 | | 50223 | | | 52223 | 54223 | | 38223 | | | |
| 0.027 | | 50273 | 52273 | 54273 | 38273 | | | | | | |
| 0.033 | | 5.0 x 10.5 x 10.0 | 0.6 | 50333 | 52333 | 1000 | 54333 | 1250 | 38333 | 1000 | |
| 0.039 | | | | 50393 | 52393 | | 54393 | | 38393 | | |
| 0.047 | | | | 50473 | 52473 | | 54473 | | 38473 | | |
| 0.056 | | 6.0 x 11.5 x 10.0 | 0.8 | 50563 | 52563 | 750 | 54563 | 1000 | 38563 | 750 | |

Notes

- SPQ = Standard Packing Quantity
- (1) For tolerances see section "Space Requirements for Printed-Circuit Board Applications and Dimension Tolerances"
- (2) Weight for short lead product only
- (3) H = in-tape height; P₀ = sprocket hole distance; for detailed specifications refer to packaging information



| ELECTRICAL DATA AND ORDERING INFORMATION - PITCH: 10 mm | | | | | | | | | | | | | | |
|---|---|--|----------------------------|--|-------------------------------------|-------|--------------------------------------|-------|---|-------|--|-----|-------|-----|
| U _{RAC} (V) | CAP. (µF) | DIMENSIONS ⁽¹⁾ w x h x l (mm) | MASS (g) ⁽²⁾ | CATALOG NUMBER BFC2 339 XXXX AND PACKAGING | | | | | | | | | | |
| | | | | LOOSE IN BOX | | | | | AMMOPACK ⁽³⁾ | | LARGE REEL (500 mm) ⁽³⁾⁽⁴⁾ | | | |
| | | | | SHORT LEADS | | | LONG LEADS | | H = 18.5 mm P ₀ = 12.7 mm | | H = 18.5 mm P ₀ = 12.7 mm | | | |
| | | | | l _t = 3.5 mm + 1 mm/- 0.5 mm | l _t = 5.0 mm ± 1.0 mm | SPQ | l _t = 25.0 mm ± 2.0 mm | SPQ | | SPQ | | SPQ | | |
| PITCH = 10.0 mm ± 0.4 mm; d _t = 0.60 mm ± 0.06 mm; C-TOL. = ± 20 % | | | | | | | | | | | | | | |
| 310 | 0.0010 | 4.0 x 10.0 x 12.5 | 0.6 | 21102 | 23102 | | 25102 | | 27102 | | | | | |
| | 0.0015 | | | 21152 | 23152 | | 25152 | | 27152 | | | | | |
| | 0.0022 | | | 21222 | 23222 | | 25222 | | 27222 | | | | | |
| | 0.0033 | | | 21332 | 23332 | | 25332 | | 27332 | | | | | |
| | 0.0047 | | | 21472 | 23472 | | 25472 | | 27472 | | | | | |
| | 0.0068 | | | 21682 | 23682 | 1000 | 25682 | 1250 | 27682 | 950 | - | - | | |
| | 0.010 | | | 21103 | 23103 | | 25103 | | 27103 | | | | | |
| | 0.015 | | | 21153 | 23153 | | 25153 | | 27153 | | | | | |
| | 0.022 | | | 21223 | 23223 | | 25223 | | 27223 | | | | | |
| | 0.033 | | | 21333 | 23333 | | 25333 | | 27333 | | | | | |
| | 0.047 | | | 21473 | 23473 | | 25473 | | 27473 | | | | | |
| | 0.068 | | | 5.0 x 11.0 x 12.5 | 0.82 | 21683 | 23683 | 1000 | 25683 | 1000 | 27683 | 750 | - | - |
| | 0.100 | | | 6.0 x 12.0 x 12.5 | 1.1 | 20104 | 22104 | 750 | 24104 | 750 | 28104 | 600 | 26104 | 900 |
| | PITCH = 10.0 mm ± 0.4 mm; d _t = 0.60 mm ± 0.06 mm; C-TOL. = ± 10 % | | | | | | | | | | | | | |
| 310 | 0.0010 | 4.0 x 10.0 x 12.5 | 0.6 | 11102 | 13102 | | 15102 | | 17102 | | | | | |
| | 0.0012 | | | 11122 | 13122 | | 15122 | | 17122 | | | | | |
| | 0.0015 | | | 11152 | 13152 | | 15152 | | 17152 | | | | | |
| | 0.0018 | | | 11182 | 13182 | | 15182 | | 17182 | | | | | |
| | 0.0022 | | | 11222 | 13222 | | 15222 | | 17222 | | | | | |
| | 0.0027 | | | 11272 | 13272 | | 15272 | | 17272 | | | | | |
| | 0.0033 | | | 11332 | 13332 | | 15332 | | 17332 | | | | | |
| | 0.0039 | | | 11392 | 13392 | | 15392 | | 17392 | | | | | |
| | 0.0047 | | | 11472 | 13472 | | 15472 | | 17472 | | | | | |
| | 0.0056 | | | 11562 | 13562 | | 15562 | | 17562 | | | | | |
| | 0.0068 | | | 11682 | 13682 | 1000 | 15682 | 1250 | 17682 | 950 | - | - | | |
| | 0.0082 | | | 11822 | 13822 | | 15822 | | 17822 | | | | | |
| | 0.010 | | | 11103 | 13103 | | 15103 | | 17103 | | | | | |
| | 0.012 | | | 11123 | 13123 | | 15123 | | 17123 | | | | | |
| | 0.015 | | | 11153 | 13153 | | 15153 | | 17153 | | | | | |
| | 0.018 | | | 11183 | 13183 | | 15183 | | 17183 | | | | | |
| | 0.022 | | | 11223 | 13223 | | 15223 | | 17223 | | | | | |
| | 0.027 | | | 11273 | 13273 | | 15273 | | 17273 | | | | | |
| | 0.033 | | | 11333 | 13333 | | 15333 | | 17333 | | | | | |
| | 0.039 | | | 11393 | 13393 | | 15393 | | 17393 | | | | | |
| 0.047 | 11473 | 13473 | | 15473 | | 17473 | | | | | | | | |
| 0.056 | 5.0 x 11.0 x 12.5 | 0.82 | 11563 | 13563 | 1000 | 15563 | 1000 | 17563 | 750 | - | - | | | |
| 0.068 | | | 10683 | 12683 | | 14683 | | 18683 | | 16683 | 1100 | | | |
| 0.082 | 6.0 x 12.0 x 12.5 | 1.1 | 10823 | 12823 | 750 | 14823 | 750 | 18823 | 600 | 16823 | 900 | | | |
| 0.100 | | | 10104 | 12104 | | 14104 | | 18104 | | 16104 | 900 | | | |



| ELECTRICAL DATA AND ORDERING INFORMATION - PITCH: 10 mm | | | | | | | | | | | | |
|--|-------------------|--|----------------------------|--|-------------------------------------|-------|--------------------------------------|-------|---|-------|--|-----|
| U _{RAC} (V) | CAP. (μF) | DIMENSIONS ⁽¹⁾ w x h x l (mm) | MASS (g) ⁽²⁾ | CATALOG NUMBER BFC2 339 XXXX AND PACKAGING | | | | | | | | |
| | | | | LOOSE IN BOX | | | | | AMMOPACK ⁽³⁾ | | LARGE REEL (500 mm) ⁽³⁾⁽⁴⁾ | |
| | | | | SHORT LEADS | | | LONG LEADS | | H = 18.5 mm P ₀ = 12.7 mm | | H = 18.5 mm P ₀ = 12.7 mm | |
| | | | | l _t = 3.5 mm + 1 mm/- 0.5 mm | l _t = 5.0 mm ± 1.0 mm | SPQ | l _t = 25.0 mm ± 2.0 mm | SPQ | | SPQ | | SPQ |
| PITCH = 10.0 mm ± 0.4 mm; d _t = 0.60 mm ± 0.06 mm; C-TOL. = ± 5 % | | | | | | | | | | | | |
| 310 | 0.0010 | 4.0 x 10.0 x 12.5 | 0.6 | 51102 | 53102 | | 55102 | | 48102 | | | |
| | 0.0012 | | | 51122 | 53122 | | 55122 | | 48122 | | | |
| | 0.0015 | | | 51152 | 53152 | | 55152 | | 48152 | | | |
| | 0.0018 | | | 51182 | 53182 | | 55182 | | 48182 | | | |
| | 0.0022 | | | 51222 | 53222 | | 55222 | | 48222 | | | |
| | 0.0027 | | | 51272 | 53272 | | 55272 | | 48272 | | | |
| | 0.0033 | | | 51332 | 53332 | | 55332 | | 48332 | | | |
| | 0.0039 | | | 51392 | 53392 | | 55392 | | 48392 | | | |
| | 0.0047 | | | 51472 | 53472 | | 55472 | | 48472 | | | |
| | 0.0056 | | | 51562 | 53562 | | 55562 | | 48562 | | | |
| | 0.0068 | | | 51682 | 53682 | 1000 | 55682 | 1250 | 48682 | 950 | - | - |
| | 0.0082 | | | 51822 | 53822 | | 55822 | | 48822 | | | |
| | 0.010 | | | 51103 | 53103 | | 55103 | | 48103 | | | |
| | 0.012 | | | 51123 | 53123 | | 55123 | | 48123 | | | |
| | 0.015 | | | 51153 | 53153 | | 55153 | | 48153 | | | |
| | 0.018 | | | 51183 | 53183 | | 55183 | | 48183 | | | |
| | 0.022 | | | 51223 | 53223 | | 55223 | | 48223 | | | |
| | 0.027 | | | 51273 | 53273 | | 55273 | | 48273 | | | |
| | 0.033 | | | 51333 | 53333 | | 55333 | | 48333 | | | |
| | 0.039 | | | 51393 | 53393 | | 55393 | | 48393 | | | |
| 0.047 | 51473 | 53473 | | 55473 | | 48473 | | | | | | |
| 0.056 | 5.0 x 11.0 x 12.5 | 0.82 | 51563 | 53563 | 1000 | 55563 | 1000 | 48563 | 750 | 46563 | 1100 | |
| 0.068 | | | 50683 | 52683 | | 54683 | | 38683 | | 36683 | | |
| 0.082 | 6.0 x 12.0 x 12.5 | 1.1 | 50823 | 52823 | 750 | 54823 | 750 | 38823 | 600 | 36823 | 900 | |

Notes

- SPQ = Standard Packing Quantity
- (1) For tolerances see section "Space Requirements for Printed-Circuit Board Applications and Dimension Tolerances"
- (2) Weight for short lead product only
- (3) H = in-tape height; P₀ = sprocket hole distance; for detailed specifications refer to packaging information
- (4) Reel diameter = 356 mm is available on request



| ELECTRICAL DATA AND ORDERING INFORMATION - PITCH: 15 mm | | | | | | | | | | | |
|---|---|--|----------------------------|---|-------------------------------------|-------|--------------------------------------|-------|--|------|--|
| U _{RAC} (V) | CAP. (µF) | DIMENSIONS ⁽¹⁾ w x h x l (mm) | MASS (g) ⁽²⁾ | CATALOG NUMBER BFC2 339 XXXXX AND PACKAGING | | | | | | | |
| | | | | LOOSE IN BOX | | | | | LARGE REEL (500 mm) ⁽³⁾⁽⁴⁾ | | |
| | | | | SHORT LEADS | | | LONG LEADS | | H = 18.5 mm P ₀ = 12.7 mm | | |
| | | | | l _t = 3.5 mm ± 0.3 mm | l _t = 5.0 mm ± 1.0 mm | SPQ | l _t = 25.0 mm ± 2.0 mm | SPQ | | SPQ | |
| PITCH = 15 mm ± 0.4 mm; d_t = 0.60 mm ± 0.06 mm; C-TOL. = ± 20 % | | | | | | | | | | | |
| 310 | 0.010 | 5.0 x 11.0 x 17.5 | 1 | 90001 | 90007 | 1250 | 90014 | 1000 | 90021 | 1100 | |
| | 0.015 | | | 90002 | 90008 | | 90015 | | 90022 | | |
| | 0.022 | | | 90003 | 90009 | | 90016 | | 90023 | | |
| | 0.033 | | | 90004 | 90011 | | 90017 | | 90024 | | |
| | 0.047 | | | 90005 | 90012 | | 90018 | | 90025 | | |
| | 0.068 | | | 90006 | 90013 | | 90019 | | 90026 | | |
| | 0.10 | | | 21104 | 23104 | | 25104 | | 27104 | | |
| | 0.15 | 6.0 x 12.0 x 17.5 | 1.4 | 20154 | 22154 | 1000 | 24154 | 1000 | 26154 | 900 | |
| | PITCH = 15 mm ± 0.4 mm; d_t = 0.80 mm ± 0.08 mm; C-TOL. = ± 20 % | | | | | | | | | | |
| | 0.22 | 7.0 x 13.5 x 17.5 | 1.8 | 20224 | 22224 | 750 | 24224 | 500 | 26224 | 800 | |
| 0.33 | 8.5 x 15.0 x 17.5 | 2.4 | 20334 | 22334 | 750 | 24334 | 500 | 26334 | 650 | | |
| 0.47 | 10.0 x 16.5 x 17.5 | 3.0 | 20474 | 22474 | 500 | 24474 | 450 | 26474 | 600 | | |
| | 8.5 x 17.5 x 18.0 | 3.1 | 90165 | 90166 | 300 | 90143 | 500 | - | - | | |
| 0.56 | 11.0 x 18.5 x 18.0 | 4.3 | 90174 | 90175 | 225 | 90176 | 350 | - | - | | |
| 0.68 | 11.0 x 18.5 x 18.0 | 5.5 | 90168 | 90169 | 225 | 90145 | 350 | - | - | | |
| PITCH = 15 mm ± 0.4 mm; d_t = 0.60 mm ± 0.06 mm; C-TOL. = ± 10 % | | | | | | | | | | | |
| 310 | 0.010 | 5.0 x 11.0 x 17.5 | 1.0 | 90027 | 90039 | 1250 | 90052 | 1000 | 90064 | 1100 | |
| | 0.012 | | | 90028 | 90041 | | 90053 | | 90065 | | |
| | 0.015 | | | 90029 | 90042 | | 90054 | | 90066 | | |
| | 0.018 | | | 90031 | 90043 | | 90055 | | 90067 | | |
| | 0.022 | | | 90032 | 90044 | | 90056 | | 90068 | | |
| | 0.027 | | | 90033 | 90045 | | 90057 | | 90069 | | |
| | 0.033 | | | 90034 | 90046 | | 90058 | | 90071 | | |
| | 0.039 | | | 90035 | 90047 | | 90059 | | 90072 | | |
| | 0.047 | | | 90036 | 90048 | | 90061 | | 90073 | | |
| | 0.056 | | | 90037 | 90049 | | 90062 | | 90074 | | |
| | 0.068 | | | 11683 | 13683 | | 15683 | | 17683 | | |
| | 0.082 | | | 11823 | 13823 | | 15823 | | 17823 | | |
| | 0.100 | | | 11104 | 13104 | | 15104 | | 17104 | | |
| | 0.12 | 6.0 x 12.0 x 17.5 | 1.4 | 10124 | 12124 | 1000 | 14124 | 1000 | 16124 | 900 | |
| | 0.15 | | | 10154 | 12154 | | 14154 | | 16154 | | |
| PITCH = 15 mm ± 0.4 mm; d_t = 0.80 mm ± 0.08 mm; C-TOL. = ± 10 % | | | | | | | | | | | |
| 0.18 | 7.0 x 13.5 x 17.5 | 1.8 | 10184 | 12184 | 750 | 14184 | 500 | 16184 | 800 | | |
| 0.22 | | | 10224 | 12224 | | 14224 | | 16224 | | | |
| 0.27 | 8.5 x 15.0 x 17.5 | 2.4 | 10274 | 12274 | 750 | 14274 | 500 | 16274 | 650 | | |
| 0.33 | | | 10334 | 12334 | | 14334 | | 16334 | | | |
| 0.39 | 10.0 x 16.5 x 17.5 | 3.0 | 10394 | 12394 | 500 | 14394 | 450 | 16394 | 600 | | |
| 0.47 | | | 10474 | 12474 | | 14474 | | 16474 | | | |
| 0.56 | 11.0 x 18.5 x 18.0 | 4.3 | 90167 | 90157 | 225 | 90144 | 400 | - | - | | |



| ELECTRICAL DATA AND ORDERING INFORMATION - PITCH: 15 mm | | | | | | | | | | |
|--|--------------|--|----------------------------|---|-------------------------------------|-------|--------------------------------------|-------|--|------|
| U _{RAC} (V) | CAP. (μF) | DIMENSIONS ⁽¹⁾ w x h x l (mm) | MASS (g) ⁽²⁾ | CATALOG NUMBER BFC2 339 XXXXX AND PACKAGING | | | | | | |
| | | | | LOOSE IN BOX | | | | | LARGE REEL (500 mm) ⁽³⁾⁽⁴⁾ | |
| | | | | SHORT LEADS | | | LONG LEADS | | H = 18.5 mm P ₀ = 12.7 mm | |
| | | | | l _t = 3.5 mm ± 0.3 mm | l _t = 5.0 mm ± 1.0 mm | SPQ | l _t = 25.0 mm ± 2.0 mm | SPQ | | SPQ |
| PITCH = 15 mm ± 0.4 mm; d _t = 0.60 mm ± 0.06 mm; C-TOL. = ± 5 % | | | | | | | | | | |
| 310 | 0.010 | 5.0 x 11.0 x 17.5 | 1.0 | 90221 | 90232 | 1250 | 90243 | 1000 | 90254 | 1100 |
| | 0.012 | | | 90222 | 90233 | | 90244 | | 90255 | |
| | 0.015 | | | 90223 | 90234 | | 90245 | | 90256 | |
| | 0.018 | | | 90224 | 90235 | | 90246 | | 90257 | |
| | 0.022 | | | 90225 | 90236 | | 90247 | | 90258 | |
| | 0.027 | | | 90226 | 90237 | | 90248 | | 90259 | |
| | 0.033 | | | 90227 | 90238 | | 90249 | | 90261 | |
| | 0.039 | | | 90228 | 90239 | | 90251 | | 90262 | |
| | 0.047 | | | 90229 | 90241 | | 90252 | | 90263 | |
| | 0.056 | | | 90231 | 90242 | | 90253 | | 90264 | |
| | 0.068 | | | 51683 | 53683 | | 55683 | | 46683 | |
| | 0.082 | | | 51823 | 53823 | | 55823 | | 46823 | |
| | 0.10 | 50104 | 52104 | 54104 | 36104 | | | | | |
| | 0.12 | 6.0 x 12.0 x 17.5 | 1.4 | 50124 | 52124 | 1000 | 54124 | 1000 | 36124 | 900 |
| 0.15 | | | 50154 | 52154 | | 54154 | | 36154 | | |
| PITCH = 15 mm ± 0.4 mm; d _t = 0.80 mm ± 0.08 mm; C-TOL. = ± 5 % | | | | | | | | | | |
| | 0.18 | 7.0 x 13.5 x 17.5 | 1.8 | 50184 | 52184 | 750 | 54184 | 500 | 36184 | 800 |
| | 0.22 | 8.5 x 15.0 x 17.5 | 2.4 | 50224 | 52224 | 750 | 54224 | 500 | 36224 | 650 |
| | 0.27 | | | 50274 | 52274 | | 54274 | | 36274 | |
| | 0.33 | | | 50334 | 52334 | | 54334 | | 36334 | |
| | 0.39 | 10.0 x 16.5 x 17.5 | 3.0 | 50394 | 52394 | 500 | 54394 | 450 | 36394 | 600 |

Notes

- SPQ = Standard Packing Quantity
- (1) For tolerances see section "Space Requirements for Printed-Circuit Board Applications and Dimension Tolerances"
- (2) Weight for short lead product only
- (3) H = in-tape height; P₀ = sprocket hole distance; for detailed specifications refer to packaging information
- (4) Reel diameter = 356 mm is available on request

| ELECTRICAL DATA AND ORDERING INFORMATION - PITCH: 22.5 mm | | | | | | | | | | |
|---|--------------|--|----------------------------|---|-------------------------------------|-----|--------------------------------------|-----|--|-----|
| U _{RAC} (V) | CAP. (μF) | DIMENSIONS ⁽¹⁾ w x h x l (mm) | MASS (g) ⁽²⁾ | CATALOG NUMBER BFC2 339 XXXXX AND PACKAGING | | | | | | |
| | | | | LOOSE IN BOX | | | | | LARGE REEL (500 mm) ⁽³⁾⁽⁴⁾ | |
| | | | | SHORT LEADS | | | LONG LEADS | | H = 18.5 mm P ₀ = 12.7 mm | |
| | | | | l _t = 3.5 mm ± 0.3 mm | l _t = 5.0 mm ± 1.0 mm | SPQ | l _t = 25.0 mm ± 2.0 mm | SPQ | | SPQ |
| PITCH = 22.5 mm ± 0.4 mm; d _t = 0.80 mm ± 0.08 mm; C-TOL. = ± 20 % | | | | | | | | | | |
| 310 | 0.15 | 6.0 x 15.5 x 26.0 | 2.4 | 21154 | 23154 | 300 | 25154 | 250 | 27154 | 600 |
| | 0.22 | | | 21224 | 23224 | | 25224 | | 27224 | |
| | 0.33 | | | 21334 | 23334 | | 25334 | | 27334 | |
| | 0.47 | 7.0 x 16.5 x 26.0 | 2.9 | 21474 | 23474 | 200 | 25474 | 250 | 27474 | 500 |
| | 0.68 | 8.5 x 18.0 x 26.0 | 3.8 | 20684 | 22684 | 200 | 24684 | 250 | 26684 | 450 |
| | 1.0 | 10.0 x 19.5 x 26.0 | 6.8 | 20105 | 22105 | 200 | 24105 | 200 | 26105 | 350 |
| | 1.5 | 12.5 x 22.5 x 26.5 | 10 | 90103 | 90138 | 140 | 90139 | 400 | 90141 | 300 |



| ELECTRICAL DATA AND ORDERING INFORMATION - PITCH: 22.5 mm | | | | | | | | | | | |
|---|--|--|----------------------------|---|-------------------------------------|-------|--------------------------------------|-------|--|-------|-----|
| U _{RAC} (V) | CAP. (μF) | DIMENSIONS ⁽¹⁾ w x h x l (mm) | MASS (g) ⁽²⁾ | CATALOG NUMBER BFC2 339 XXXXX AND PACKAGING | | | | | | | |
| | | | | LOOSE IN BOX | | | | | LARGE REEL (500 mm) ⁽³⁾⁽⁴⁾ | | |
| | | | | SHORT LEADS | | | LONG LEADS | | H = 18.5 mm P ₀ = 12.7 mm | | |
| | | | | l _t = 3.5 mm ± 0.3 mm | l _t = 5.0 mm ± 1.0 mm | SPQ | l _t = 25.0 mm ± 2.0 mm | SPQ | | SPQ | |
| PITCH = 22.5 mm ± 0.4 mm; d _t = 0.80 mm ± 0.08 mm; C-TOL. = ± 10 % | | | | | | | | | | | |
| 310 | 0.12 | 6.0 x 15.5 x 26.0 | 2.4 | 11124 | 13124 | 300 | 15124 | 250 | 17124 | 600 | |
| | 0.15 | | | 11154 | 13154 | | 15154 | | 17154 | | |
| | 0.18 | | | 11184 | 13184 | | 15184 | | 17184 | | |
| | 0.22 | | | 11224 | 13224 | | 15224 | | 17224 | | |
| | 0.27 | | | 11274 | 13274 | | 15274 | | 17274 | | |
| | 0.33 | | | 11334 | 13334 | | 15334 | | 17334 | | |
| | 0.33 | 8.5 x 14.0 x 26.5 | 3.6 | - | - | - | 75334 | 800 | - | - | |
| | 0.39 | 7.0 x 16.5 x 26.0 | 2.9 | 11394 | 13394 | 200 | 15394 | 250 | 17394 | 500 | |
| | 0.47 | | | 11474 | 13474 | | 15474 | | 17474 | | |
| | 0.47 | 8.5 x 14.0 x 26.5 | 3.6 | - | - | - | 75474 | 800 | - | - | |
| | 0.56 | 8.5 x 18.0 x 26.0 | 3.8 | 10564 | 12564 | 200 | 14564 | 250 | 16564 | 450 | |
| | 0.68 | 10.0 x 19.5 x 26.0 | 6.8 | 10684 | 12684 | 200 | 14684 | 200 | 16684 | 350 | |
| | 0.82 | | | 10824 | 12824 | | 14824 | | 16824 | | |
| | 1.0 | 12.0 x 22.0 x 26.0 | 7.8 | 10105 | 12105 | 150 | 14105 | 200 | 16105 | 300 | |
| | PITCH = 22.5 mm ± 0.4 mm; d _t = 0.80 mm ± 0.08 mm; C-TOL. = ± 5 % | | | | | | | | | | |
| | 310 | 0.12 | 6.0 x 15.5 x 26.0 | 2.4 | 51124 | 53124 | 300 | 55124 | 250 | 46124 | 600 |
| | | 0.15 | | | 51154 | 53154 | | 55154 | | 46154 | |
| | | 0.18 | | | 51184 | 53184 | | 55184 | | 46184 | |
| | | 0.22 | | | 51224 | 53224 | | 55224 | | 46224 | |
| | | 0.27 | | | 51274 | 53274 | | 55274 | | 46274 | |
| 0.33 | | 51334 | | | 53334 | 55334 | | 46334 | | | |
| 0.39 | | 7.0 x 16.5 x 26.0 | 2.9 | 51394 | 53394 | 200 | 55394 | 250 | 46394 | 500 | |
| 0.47 | | 8.5 x 18.0 x 26.0 | 3.8 | 51474 | 53474 | 200 | 55474 | 250 | 46474 | 450 | |
| 0.56 | | | | 50564 | 52564 | | 54564 | | 36564 | | |
| 0.68 | | 10.0 x 19.5 x 26.0 | 6.8 | 50684 | 52684 | 200 | 54684 | 200 | 36684 | 350 | |
| 0.82 | | | | 50824 | 52824 | | 54824 | | 36824 | | |
| 1.0 | | 12.0 x 22.0 x 26.0 | 7.8 | 50105 | 52105 | 150 | 54105 | 200 | 36105 | 300 | |

Notes

- SPQ = Standard Packing Quantity
- (1) For tolerances see section "Space Requirements for Printed-Circuit Board Applications and Dimension Tolerances"
- (2) Weight for short lead product only
- (3) H = in-tape height; P₀ = sprocket hole distance; for detailed specifications refer to packaging information
- (4) Reel diameter = 356 mm is available on request



| ELECTRICAL DATA AND ORDERING INFORMATION - PITCH: 27.5 mm | | | | | | | | | |
|---|---|--|----------------------------|---|----------------------------------|-------|-----------------------------------|-----|--|
| U _{RAC} (V) | CAP. (μF) | DIMENSIONS ⁽¹⁾ w x h x l (mm) | MASS (g) ⁽²⁾ | CATALOG NUMBER BFC2 339 XXXXX AND PACKAGING | | | | | |
| | | | | LOOSE IN BOX | | | | | |
| | | | | SHORT LEADS | | | LONG LEADS | | |
| | | | | l _t = 3.5 mm ± 0.3 mm | l _t = 5.0 mm ± 1.0 mm | SPQ | l _t = 25.0 mm ± 2.0 mm | SPQ | |
| PITCH = 27.5 mm ± 0.4 mm; d_t = 0.80 mm ± 0.08 mm; C-TOL. = ± 20 % | | | | | | | | | |
| 310 | 0.47 | 9.0 x 19.0 x 31.5 | 5.5 | 90076 | 90078 | 100 | 90081 | 150 | |
| | 0.68 | | | 21684 | 23684 | | 25684 | | |
| | 1.0 | 11.0 x 21.0 x 31.0 | 7.4 | 21105 | 23105 | 100 | 25105 | 125 | |
| | 1.5 | 13.0 x 23.0 x 31.0 | 9.2 | 20155 | 22155 | 100 | 24155 | 125 | |
| | 2.2 | 15.0 x 25.0 x 31.5 | 12.3 | 20225 | 22225 | 100 | 24225 | 125 | |
| | 3.3 | 18.0 x 28.0 x 31.5 | 16.1 | 20335 | 22335 | 100 | 24335 | 100 | |
| | 4.7 | 21.0 x 31.0 x 31.0 | 20.3 | 20475 | 22475 | 50 | 24475 | 75 | |
| | PITCH = 27.5 mm ± 0.4 mm; d_t = 0.80 mm ± 0.08 mm; C-TOL. = ± 10 % | | | | | | | | |
| | 0.68 | 9.0 x 19.0 x 31.5 | 5.5 | 11684 | 13684 | 100 | 15684 | 150 | |
| | 0.82 | 11.0 x 21.0 x 31.0 | 7.4 | 11824 | 13824 | 100 | 15824 | 125 | |
| | 1.0 | | | 11105 | 13105 | | 15105 | | |
| | 1.2 | | | 10125 | 12125 | | 14125 | | |
| | 1.5 | 13.0 x 23.0 x 31.0 | 9.2 | 10155 | 12155 | 100 | 14155 | 125 | |
| | 1.8 | 15.0 x 25.0 x 31.5 | 12.3 | 10185 | 12185 | 100 | 14185 | 125 | |
| 2.2 | 10225 | | | 12225 | 14225 | | | | |
| 2.7 | 18.0 x 28.0 x 31.5 | 16.1 | 10275 | 12275 | 100 | 14275 | 100 | | |
| 3.3 | 21.0 x 31.0 x 31.0 | 20.3 | 10335 | 12335 | 50 | 14335 | 75 | | |
| 3.9 | | | 10395 | 12395 | | 14395 | | | |
| PITCH = 27.5 mm ± 0.4 mm; d_t = 0.80 mm ± 0.08 mm; C-TOL. = ± 5 % | | | | | | | | | |
| 0.68 | 9.0 x 19.0 x 31.5 | 5.5 | 51684 | 53684 | 100 | 55684 | 150 | | |
| 0.82 | 11.0 x 21.0 x 31.0 | 7.4 | 51824 | 53824 | 100 | 55824 | 125 | | |
| 1.0 | | | 51105 | 53105 | | 55105 | | | |
| 1.2 | 13.0 x 23.0 x 31.0 | 9.2 | 50125 | 52125 | 100 | 54125 | 125 | | |
| 1.5 | | | 50155 | 52155 | | 54155 | | | |
| 1.8 | 15.0 x 25.0 x 31.5 | 12.3 | 50185 | 52185 | 100 | 54185 | 125 | | |
| 2.2 | 18.0 x 28.0 x 31.5 | 16.1 | 50225 | 52225 | 100 | 54225 | 100 | | |
| 2.7 | | | 50275 | 52275 | | 54275 | | | |
| 3.3 | 21.0 x 31.0 x 31.0 | 20.3 | 50335 | 52335 | 50 | 54335 | 75 | | |

Notes

- SPQ = Standard Packing Quantity
- (1) For tolerances see section "Space Requirements for Printed-Circuit Board Applications and Dimension Tolerances"
- (2) Weight for short lead product only

| APPROVALS | | | | |
|---|---------------------|----------------|-----------------------|--|
| SAFETY APPROVALS X2 | VOLTAGE | VALUE | FILE NUMBERS | LINK |
| EN 60384-14 (ENEC) (= IEC 60384-14 ed-4 (2013)) | 310 V _{AC} | 1 nF to 4.7 μF | ENEC16/FI/21/01054/A2 | www.vishay.com/doc?28179 |
| UL 60384-14 | 310 V _{AC} | 1 nF to 4.7 μF | E354331 | www.vishay.com/doc?28184 |
| CSA-E384-14 | 310 V _{AC} | 1 nF to 4.7 μF | E354331 | |
| CQC | 310 V _{AC} | 1 nF to 4.7 μF | CQC 07001021281 (L) | www.vishay.com/doc?28180 |
| | | | CQC 06001018290 (F) | www.vishay.com/doc?28181 |
| CB test certificate | 310 V _{AC} | 1 nF to 4.7 μF | FI-39827/A1 | www.vishay.com/doc?28175 |
| The ENEC-approval together with the CB-certificate replace all national marks of the following countries (they have already signed the ENEC-agreement): Austria; Belgium; Czech. Republic; Denmark; Finland; France; Germany; Greece; Hungary; Ireland; Italy; Luxembourg; Netherlands; Norway; Portugal; Slovenian; Spain; Sweden; Switzerland and United Kingdom. | | | | |
| | | | | |

MOUNTING

Normal Use

The capacitors are designed for mounting on printed circuit boards. The capacitors packed in bandoliers are designed for mounting in printed-circuit boards by means of automatic insertion machines.

For detailed tape specifications refer to “Packaging Information” www.vishay.com/doc?28139 or end of catalog.

Specific Method of Mounting to Withstand Vibration and Shock

In order to withstand vibration and shock tests, it must be insured that the stand-off pips are in good contact with the printed-circuit board:

- For pitches ≤ 15 mm capacitors shall be mechanically fixed by the leads.
- For larger pitches the capacitors shall be mounted in the same way and the body clamped.

Space Requirements for Printed-Circuit Board Applications and Dimension Tolerances

The maximum space for length ($l_{max.}$), width ($w_{max.}$), and height ($h_{max.}$) of film capacitors to take in account on the printed circuit board is shown in the drawings:

- For products with pitch ≤ 15 mm, $\Delta w = \Delta l = 0.3$ mm, $\Delta h = 0.1$ mm
- For products with 15 mm $<$ pitch ≤ 27.5 mm, $\Delta w = \Delta l = 0.5$ mm, $\Delta h = 0.1$ mm

Eccentricity defined as in drawing. The maximum eccentricity is smaller than or equal to the lead diameter of the product concerned.

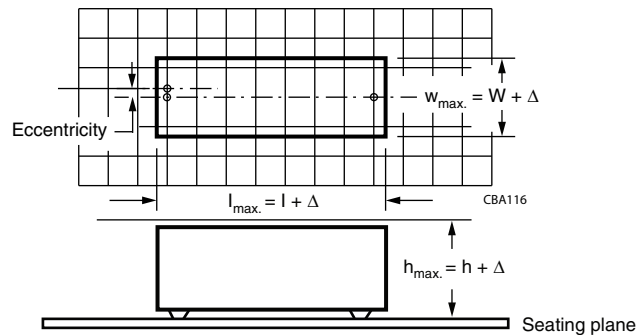

For the minimum product dimensions for length ($l_{min.}$), width ($w_{min.}$), and height ($h_{min.}$) following tolerances of the components are valid:

$l_{min.} = l - \Delta l$, $w_{min.} = w - \Delta w$ and $h_{min.} = h - \Delta h$ following

- For products with pitch ≤ 10 mm, $\Delta l = 0.3$ mm and $\Delta w = \Delta h = 0.3$ mm
- For products with pitch = 15 mm, $\Delta l = 0.5$ mm and $\Delta w = \Delta h = 0.5$ mm
- For products with 15 mm $<$ pitch ≤ 27.5 mm, $\Delta l = 1.0$ mm and $\Delta w = \Delta h = 0.5$ mm



SOLDERING CONDITIONS

For general soldering conditions and wave soldering profile, we refer to the application note: "Soldering Guidelines for Film Capacitors": www.vishay.com/doc?28171

Storage Temperature

Tstg = -25 °C to +35 °C, RH maximum 75 % without condensation

Ratings and Characteristics Reference Conditions

Unless otherwise specified, all electrical values apply to an ambient temperature of 23 °C ± 1 °C, an atmospheric pressure of 86 kPa to 106 kPa and a relative humidity of 50 % ± 2 %.

For reference testing, a conditioning period shall be applied over 96 h ± 4 h by heating the products in a circulating air oven at the rated temperature and a relative humidity not exceeding 20 %.

CHARACTERISTICS

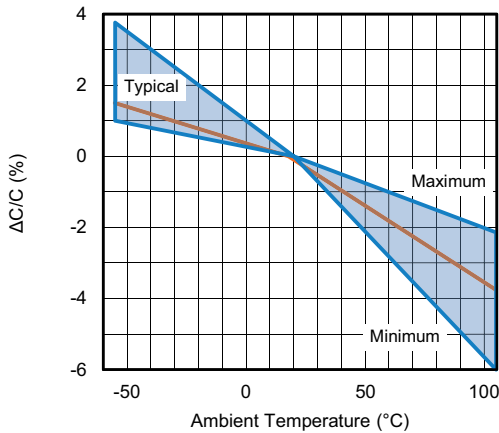

Capacitance as a function of ambient temperature (typical curve)

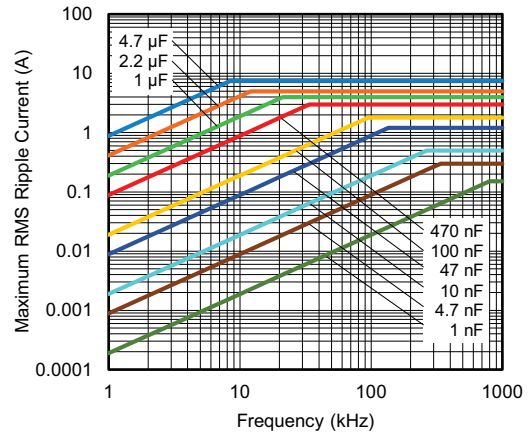

Maximum RMS current as a function of frequency

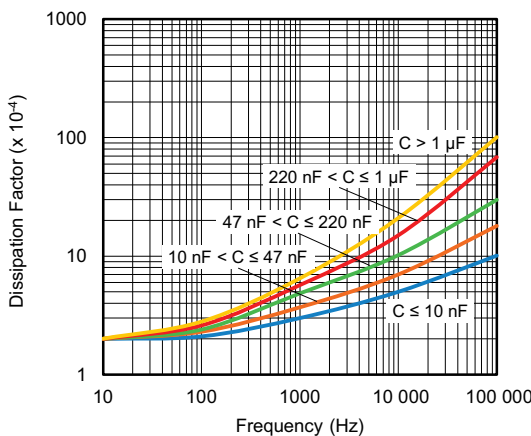

Tangent of loss angle as a function of frequency (typical curve)

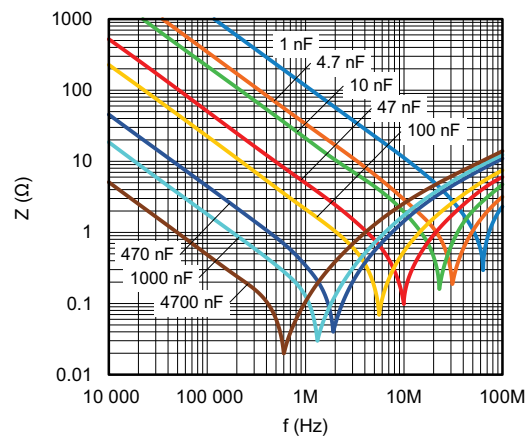

Impedance as a function of frequency (typical curve)

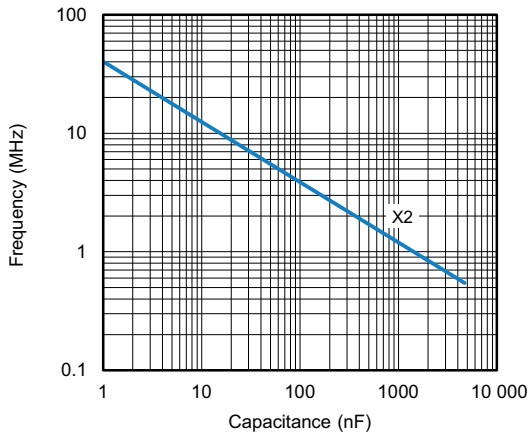

Resonant frequency as a function of capacitance (typical curve)

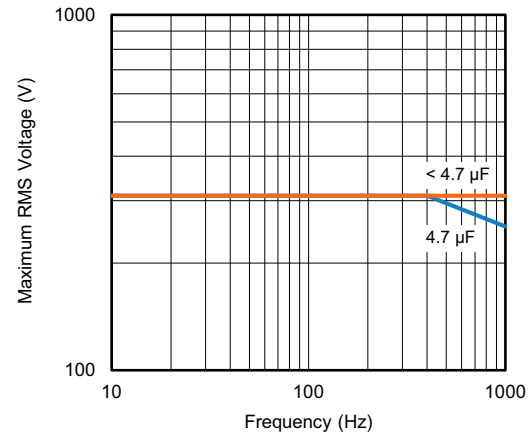

Maximum RMS voltage as a function of frequency

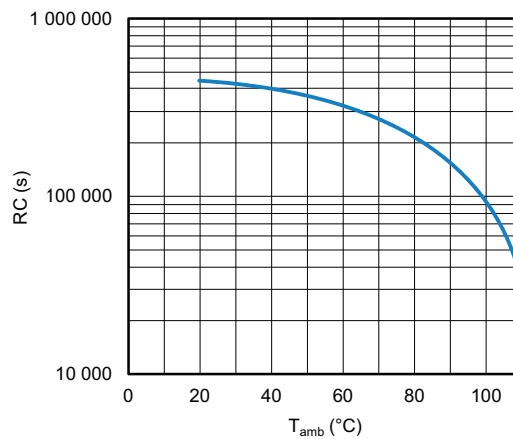

Insulation resistance as a function of ambient temperature (typical curve)

APPLICATION NOTES

- For X2 electromagnetic interference suppression in **standard across the line applications** (50 Hz / 60 Hz) with a maximum mains voltage of 310 V_{AC}
- For series impedance applications we refer to application note www.vishay.com/doc?28153
- For capacitors connected in parallel, normally the proof voltage and possibly the rated voltage must be reduced. For information depending of the capacitance value and the number of parallel connections contact: rfi@vishay.com
- These capacitors are not intended for continuous pulse application. For these situations capacitors of the AC and pulse programs must be used
- The maximum ambient temperature must not exceed 110 °C (125 °C for less than 1000 h) for C ≤ 470 nF and 110 °C for C > 470 nF
- Rated voltage pulse slope:
If the pulse voltage is lower than the rated voltage, the values of the specific reference data can be multiplied by 435 V_{DC} and divided by the applied voltage



INSPECTION REQUIREMENTS

General Notes

Sub-clause numbers of tests and performance requirements refer to the "Sectional Specification, publication IEC 60384-14 ed-4 (2013) and Specific Reference Data.

| GROUP C INSPECTION REQUIREMENTS | | |
|---|--|--|
| SUB-CLAUSE NUMBER AND TEST | CONDITIONS | PERFORMANCE REQUIREMENTS |
| SUB-GROUP C1A PART OF SAMPLE OF SUB-GROUP C1 | | |
| 4.1 Dimensions (detail) Initial measurements | Capacitance Tangent of loss angle: For C ≤ 1 μF at 10 kHz For C > 1 μF at 1 kHz | As specified in section "General data" of this specification |
| 4.3 Robustness of terminations | Tensile: load 10 N; 10 s Bending: load 5 N; 4 x 90° | No visible damage |
| 4.4 Resistance to soldering heat | No pre-drying Method: 1A Solder bath: 280 °C ± 5 °C Duration: 10 s | |
| 4.19 Component solvent resistance | Isopropylalcohol at room temperature Method: 2 Immersion time: 5 min ± 0.5 min Recovery time: Min. 1 h, max. 2 h | |
| 4.4.2 Final measurements | Visual examination Capacitance Tangent of loss angle Insulation resistance | No visible damage Legible marking ΔC/C ≤ 5 % of the value measured initially. Increase of tan δ: ≤ 0.008 for: C ≤ 1 μF or ≤ 0.005 for: C > 1 μF Compared to values measured initially As specified in section "Insulation Resistance" of this specification |
| SUB-GROUP C1B PART OF SAMPLE OF SUB-GROUP C1 | | |
| Initial measurements | Capacitance Tangent of loss angle: For C ≤ 1 μF at 10 kHz For C > 1 μF at 1 kHz | |
| 4.20 Solvent resistance of the marking | Isopropylalcohol at room temperature Method: 1 Rubbing material: Cotton wool Immersion time: 5 min ± 0.5 min | No visible damage Legible marking |



| GROUP C INSPECTION REQUIREMENTS | | |
|--|--|--|
| SUB-CLAUSE NUMBER AND TEST | CONDITIONS | PERFORMANCE REQUIREMENTS |
| SUB-GROUP C1B PART OF SAMPLE OF SUB-GROUP C1 | | |
| 4.6 Rapid change of temperature | <p>θA = -55 °C θB = +110 °C 5 cycles Duration t = 30 min</p> | |
| 4.6.1 Inspection | Visual examination | No visible damage |
| 4.7 Vibration | <p>Mounting: see section "Mounting" of this specification Procedure B4 Frequency range: 10 Hz to 55 Hz Amplitude: 0.75 mm or acceleration 98 m/s² (whichever is less severe) Total duration 6 h</p> | |
| 4.7.2 Final inspection | Visual examination | No visible damage |
| 4.9 Shock | <p>Mounting: see section "Mounting" for more information Pulse shape: half sine Acceleration: 490 m/s² Duration of pulse: 11 ms</p> | |
| 4.9.2 Final measurements | <p>Visual examination</p> <p>Capacitance</p> <p>Tangent of loss angle</p> <p>Insulation resistance</p> | <p>No visible damage</p> <p>$\Delta C/C \leq 5\%$ of the value measured initially.</p> <p>Increase of tan δ: ≤ 0.008 for: $C \leq 1 \mu\text{F}$ or ≤ 0.005 for: $C > 1 \mu\text{F}$ Compared to values measured initially</p> <p>As specified in section "Insulation Resistance" of this specification</p> |
| SUB-GROUP C1 COMBINED SAMPLE OF SPECIMENS OF SUB-GROUPS C1A AND C1B | | |
| 4.11 Climatic sequence | | |
| 4.11.1 Initial measurements | <p>Capacitance Measured in 4.4.2 and 4.9.2 Tangent of loss angle: Measured initially in C1A and C1B</p> | |
| 4.11.2 Dry heat | Temperature: 110 °C | |
| 4.11.3 Damp heat cyclic Test Db First cycle | Duration: 16 h | |
| 4.11.4 Cold | Temperature: -55 °C | |
| 4.11.5 Damp heat cyclic Test Db remaining cycles | Duration: 2 h | |



| GROUP C INSPECTION REQUIREMENTS | | |
|--|---|--|
| SUB-CLAUSE NUMBER AND TEST | CONDITIONS | PERFORMANCE REQUIREMENTS |
| SUB-GROUP C1 COMBINED SAMPLE OF SPECIMENS OF SUB-GROUPS C1A AND C1B | | |
| 4.11.6 Final measurements | Visual examination Capacitance Tangent of loss angle Voltage proof 1350 V _{DC} ; 1 min between terminations Insulation resistance | No visible damage Legible marking $ \Delta C/C \leq 5\%$ of the value measured in 4.11.1. Increase of tan δ : ≤ 0.008 for: $C \leq 1 \mu\text{F}$ or ≤ 0.005 for: $C > 1 \mu\text{F}$ Compared to values measured in 4.11.1. No permanent breakdown or flash-over $\geq 50\%$ of values specified in section "Insulation Resistance" of this specification |
| SUB-GROUP C2 | | |
| 4.12 Damp heat steady state | 56 days; 40 °C; 90 % to 95 % RH no load | |
| 4.12.1 Initial measurements | Capacitance Tangent of loss angle: at 1 kHz | |
| 4.12.3 Final measurements | Visual examination Capacitance Tangent of loss angle Voltage proof 1350 V _{DC} ; 1 min between terminations Insulation resistance | No visible damage Legible marking $ \Delta C/C \leq 5\%$ of the value measured in 4.12.1 Increase of tan δ : ≤ 0.008 for: $C \leq 1 \mu\text{F}$ or ≤ 0.005 for: $C > 1 \mu\text{F}$ Compared to values measured in 4.12.1 No permanent breakdown or flash-over $\geq 50\%$ of values specified in section "Insulation Resistance" of this specification |
| SUB-GROUP C3 | | |
| 4.13.1 Initial measurements | Capacitance Tangent of loss angle: For $C \leq 1 \mu\text{F}$ at 10 kHz For $C > 1 \mu\text{F}$ at 1 kHz | |
| 4.13 Impulse voltage | 3 successive impulses, full wave, peak voltage: X2: 2.5 kV for $C \leq 1 \mu\text{F}$ X2: 2.5 kV/ \sqrt{C} for $C > 1 \mu\text{F}$ Max. 24 pulses | No self healing breakdowns or flash-over |

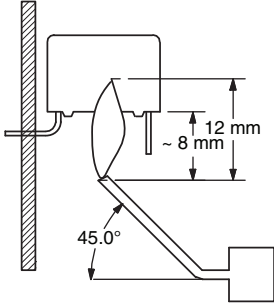

| GROUP C INSPECTION REQUIREMENTS | | |
|--|---|--|
| SUB-CLAUSE NUMBER AND TEST | CONDITIONS | PERFORMANCE REQUIREMENTS |
| SUB-GROUP C3 | | |
| 4.14 Endurance | Duration: 1000 h 1.25 x U _{RAC} at 110 °C Once in every hour the voltage is increased to 1000 V _{RMS} for 0.1 s via resistor of 47 Ω ± 5 % | |
| 4.14.7 Final measurements | Visual examination Capacitance Tangent of loss angle Voltage proof 1350 V _{DC} ; 1 min between terminations 2120 V _{AC} ; 1 min between terminations and case Insulation resistance | No visible damage Legible marking ΔC/C ≤ 10 % compared to values measured in 4.13.1 Increase of tan δ: ≤ 0.008 for: C ≤ 1 μF or ≤ 0.005 for: C > 1 μF Compared to values measured in 4.13.1 No permanent breakdown or flash-over ≥ 50 % of values specified in section "Insulation Resistance" of this specification |
| SUB-GROUP C4 | | |
| 4.15 Charge and discharge | 10 000 cycles charged to 435 V _{DC} Discharge resistance: $R = \frac{435 V_{DC}}{1.25 \times C (dU/dt)}$ | |
| 4.15.1 Initial measurements | Capacitance Tangent of loss angle: For C ≤ 1 μF at 10 kHz For C > 1 μF at 1 kHz | |
| 4.15.3 Final measurements | Capacitance Tangent of loss angle Insulation resistance | ΔC/C ≤ 10 % compared to values measured in 4.15.1. Increase of tan δ: ≤ 0.008 for: C ≤ 1 μF or ≤ 0.005 for: C > 1 μF Compared to values measured in 4.15.1 ≥ 50 % of values specified in section "Insulation Resistance" of this specification |
| SUB-GROUP C5 | | |
| 4.16 Radio frequency characteristic | Resonance frequency | ≥ 0.9 times the value as specified in section "Resonant Frequency" of this specification. |

| GROUP C INSPECTION REQUIREMENTS | | |
|--|--|--|
| SUB-CLAUSE NUMBER AND TEST | CONDITIONS | PERFORMANCE REQUIREMENTS |
| SUB-GROUP C6 | | |
| 4.17 Passive flammability Class B | Bore of gas jet: \varnothing 0.5 mm Fuel: butane Test duration for actual volume V in mm ³ : $V \leq 250$: 10 s $250 < V \leq 500$: 20 s $500 < V \leq 1750$: 30 s $V > 1750$: 60 s One flame application  | After removing test flame from capacitor, the capacitor must not continue to burn for more than 10 s. No burning particle must drop from the sample. |
| SUB-GROUP C7 | | |
| 4.18 Active flammability | 20 cycles of 2.5 kV discharges on the test capacitor connected to U_{RAC} | The cheese cloth around the capacitors shall not burn with a flame. No electrical measurements are required. |
| SUB-GROUP ADD 6 | | |
| A.6 Endurance | Duration: 1000 h for $C \leq 0.47 \mu\text{F}$ 500 h for $C > 0.47 \mu\text{F}$ $1.0 \times U_{RAC}$ at 125 °C | |
| A.6.1 Initial measurements | Capacitance Tangent of loss angle: for $C \leq 1 \mu\text{F}$ at 10 kHz for $C > 1 \mu\text{F}$ at 1 kHz | |
| A.6.2 Final measurements | Visual examination Capacitance Tangent of loss angle Insulation resistance. | No visible damage Legible marking $ \Delta C/C \leq 10\%$ of the value measured in A.6.1 Increase of $\tan \delta$: ≤ 0.008 for: $C \leq 1 \mu\text{F}$ or ≤ 0.005 for: $C > 1 \mu\text{F}$ Compared to values measured in A.6.1 $\geq 50\%$ of values specified in section "Insulation resistance" of this specification |
| SUB-GROUP ADD 7 | | |
| A.7 Endurance | Duration: 500 h $0.625 \times U_{RDC}$ at 125 °C | |
| A.7.1 Initial measurements | Capacitance Tangent of loss angle: for $C \leq 1 \mu\text{F}$ at 10 kHz for $C > 1 \mu\text{F}$ at 1 kHz | |



| GROUP C INSPECTION REQUIREMENTS | | |
|---|---|--|
| SUB-CLAUSE NUMBER AND TEST | CONDITIONS | PERFORMANCE REQUIREMENTS |
| SUB-GROUP ADD 7 | | |
| A.7.2 Final measurements | Visual examination Capacitance Tangent of loss angle Insulation resistance | No visible damage Legible marking $ \Delta C/C \leq 10\%$ of the value measured in A.7.1 Increase of $\tan \delta$: ≤ 0.008 for: $C \leq 1 \mu F$ or ≤ 0.005 for: $C > 1 \mu F$ Compared to values measured in A.7.1 $\geq 50\%$ of values specified in section "Insulation resistance" of this specification |
| SUB-GROUP ADD8 | | |
| A.8 Damp heat steady state with voltage | RH: 40 %; temp.: 93 °C, voltage: 310 V _{AC} Duration: 21 days | |
| A.8.1 Initial measurements | Capacitance Tangent of loss angle: at 10 kHz | |
| A.8.2 Final measurements | Visual examination Capacitance Tangent of loss angle Insulation resistance | No visible damage Legible marking $ \Delta C/C \leq 10\%$ of the value with initial measurement A.8.1 Increase of $\tan \delta \leq 0.024$ Compared to values with initial measurement A.8.1 $\geq 50\%$ of values specified in section "Insulation Resistance" of this specification |



| TEST CONDITIONS AND REQUIREMENTS ACCORDING AEC-Q200 REVISION C | | | | |
|--|--------------------------------------|------------------------|---|---|
| NO. | TEST NAME | REFERENCE | TEST CONDITIONS | PERFORMANCE REQUIREMENTS |
| 1 | Pre- and post-stress electrical test | User spec. | - | - |
| 3 | High temperature exposure (storage) | MIL-STD 202 method 108 | 1000 h; 110 °C; unpowered | $ \Delta C/C \leq \pm 5 \%$ Increase of $\tan \delta$ 0.008 for $C \leq 1 \mu\text{F}$ at 10 kHz or 0.005 for $C > 1 \mu\text{F}$ at 1 kHz $IR \geq 50 \%$ of initial requirement |
| 4 | Temperature cycling | JESD22 method JA-104 | 1000 cycles: -55 °C to +110 °C 10 min. dwell time each | $ \Delta C/C \leq \pm 5 \%$ Increase of $\tan \delta = 0.008$ at 10 kHz $IR \geq 50 \%$ of initial requirement |
| 6 | Moisture resistance | MIL-STD 202 method 106 | 10 cycles at 24 h/cycle unpowered | $ \Delta C/C \leq \pm 5 \%$ Increase of $\tan \delta$ 0.008 for $C \leq 1 \mu\text{F}$ at 10 kHz or 0.005 for $C > 1 \mu\text{F}$ at 1 kHz $IR \geq 50 \%$ of initial requirement |
| 7 | Biased humidity | MIL-STD 202 method 103 | 1000 h; 40 °C; 93 % RH with U_{RAC} | $ \Delta C/C \leq \pm 10 \%$ Increase of $\tan \delta$ 0.008 for $C \leq 1 \mu\text{F}$ at 10 kHz or 0.005 for $C > 1 \mu\text{F}$ at 1 kHz $IR \geq 50 \%$ of initial requirement |
| 8 | Operational life | MIL-STD 202 method 108 | $T_{amb} = 110 \text{ °C}$; 1000 h; $U_{test} = 1 \times U_{RAC}$ | $ \Delta C/C \leq \pm 10 \%$ Increase of $\tan \delta$ 0.008 for $C \leq 1 \mu\text{F}$ at 10 kHz or 0.005 for $C > 1 \mu\text{F}$ at 1 kHz $IR \geq 50 \%$ of initial requirement |
| 11 | Terminal strength (lead) | MIL-STD 202 method 211 | Leaded device lead integrity only. | $ \Delta C/C \leq \pm 5 \%$ Increase of $\tan \delta$ 0.008 for $C \leq 1 \mu\text{F}$ at 10 kHz or 0.005 for $C > 1 \mu\text{F}$ at 1 kHz $IR = \text{initial requirement}$ |
| 12 | Resistance to solvents | MIL-STD 202 method 215 | | No visual damage Legible marking |
| 13 | Mechanical shock | MIL-STD 202 method 213 | Figure a of method 213, condition C | No visual damage |
| 14 | Vibration | MIL-STD 202 method 204 | 5 g's for 20 min; 12 cycles, 3 orientations | No visual damage |
| 15 | Resistance to soldering heat | MIL-STD 202 method 210 | 260 °C; 10 s | $ \Delta C/C \leq \pm 5 \%$ Increase of $\tan \delta$ 0.008 for $C \leq 1 \mu\text{F}$ at 10 kHz or 0.005 for $C > 1 \mu\text{F}$ at 1 kHz $IR = \text{initial requirement}$ |
| 18 | Solderability | J-STD-002 | 235 °C / 5 s | Good tinning as evidence by free flowing of the solder with wetting of terminations > 95 % |
| 19 | Electrical characterization | User spec. | - | - |
| 20 | Flammability | UL 94 | Electrical test not required | Maximum permitted burning time < 10 s |



Disclaimer

ALL PRODUCT, PRODUCT SPECIFICATIONS AND DATA ARE SUBJECT TO CHANGE WITHOUT NOTICE TO IMPROVE RELIABILITY, FUNCTION OR DESIGN OR OTHERWISE.

Vishay Intertechnology, Inc., its affiliates, agents, and employees, and all persons acting on its or their behalf (collectively, "Vishay"), disclaim any and all liability for any errors, inaccuracies or incompleteness contained in any datasheet or in any other disclosure relating to any product.

Vishay makes no warranty, representation or guarantee regarding the suitability of the products for any particular purpose or the continuing production of any product. To the maximum extent permitted by applicable law, Vishay disclaims (i) any and all liability arising out of the application or use of any product, (ii) any and all liability, including without limitation special, consequential or incidental damages, and (iii) any and all implied warranties, including warranties of fitness for particular purpose, non-infringement and merchantability.

Statements regarding the suitability of products for certain types of applications are based on Vishay's knowledge of typical requirements that are often placed on Vishay products in generic applications. Such statements are not binding statements about the suitability of products for a particular application. It is the customer's responsibility to validate that a particular product with the properties described in the product specification is suitable for use in a particular application. Parameters provided in datasheets and / or specifications may vary in different applications and performance may vary over time. All operating parameters, including typical parameters, must be validated for each customer application by the customer's technical experts. Product specifications do not expand or otherwise modify Vishay's terms and conditions of purchase, including but not limited to the warranty expressed therein.

Hyperlinks included in this datasheet may direct users to third-party websites. These links are provided as a convenience and for informational purposes only. Inclusion of these hyperlinks does not constitute an endorsement or an approval by Vishay of any of the products, services or opinions of the corporation, organization or individual associated with the third-party website. Vishay disclaims any and all liability and bears no responsibility for the accuracy, legality or content of the third-party website or for that of subsequent links.

Vishay products are not designed for use in life-saving or life-sustaining applications or any application in which the failure of the Vishay product could result in personal injury or death unless specifically qualified in writing by Vishay. Customers using or selling Vishay products not expressly indicated for use in such applications do so at their own risk. Please contact authorized Vishay personnel to obtain written terms and conditions regarding products designed for such applications.

No license, express or implied, by estoppel or otherwise, to any intellectual property rights is granted by this document or by any conduct of Vishay. Product names and markings noted herein may be trademarks of their respective owners.