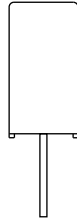
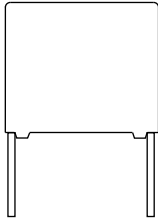

Interference Suppression Film Capacitors MKP Radial Potted Type

FEATURES

- AEC-Q200 qualified (rev. C) up to 110 °C
- THB: 40 °C / 93 % RH for 1000 h at rated voltage, in compliance with AEC-Q200
- Compliant with IEC 60384-14: AMD1 grade IA
- High temperature capabilities, up to 125 °C
- Material categorization: for definitions of compliance please see www.vishay.com/doc?99912

 AUTOMOTIVE
GRADE

RoHS
COMPLIANT

APPLICATIONS

For standard across the line X2 applications.

 See also application note: www.vishay.com/doc?28153

QUICK REFERENCE DATA	
Rated capacitance range (E12 series)	0.001 μ F to 4.7 μ F (preferred values acc. to E6)
Capacitance tolerance	± 20 %; ± 10 %; ± 5 %
Rated voltage range, U_{RAC}	310 V_{AC} ; 50 Hz to 60 Hz
Permissible DC voltage	800 V_{DC} at 85 °C 630 V_{DC} at 110 °C
Climatic testing class	55/110/56/C for product volumes ≤ 1750 mm ³ 55/110/56/B for product volumes > 1750 mm ³
Rated temperature	110 °C
Maximum application temperature	125 °C for limited time
Reference standards	IEC 60384-14:2013 IEC 60384-14:2013 / AMD1:2016 EN 60384-14:2013 + AMD1:2016 IEC 60065 requires pass. flamm. class B for volumes > 1750 mm ³ UL 60384-14 CSA-E384-14 CQC
Dielectric	Polypropylene film
Electrodes	Metallized
Construction	Mono construction 
Encapsulation	Plastic case, epoxy resin sealed, flame retardant UL-class 94 V-0
Leads	Tinned wire
Marking	C-value; tolerance; rated voltage; sub-class; manufacturer's type; code for dielectric material, manufacturer location; manufacturer's logo; year and week; safety approvals

Note

- For more detailed data and test requirements, contact rfi@vishay.com

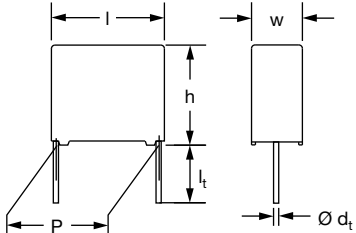
DIMENSIONS in millimeters



COMPOSITION OF CATALOG NUMBER



TYPE	PACKAGING	STANDARD DIMENSIONS	C-TOL.	CODE NUMBER		
339 X2	Loose in box	Lead length 3.5 mm + 1 mm/- 0.5 mm or 3.5 mm ± 0.3 mm	± 20 %	BFC2 339 20...		
		Lead length 5.0 mm ± 1.0 mm		BFC2 339 22...		
		Lead length 25.0 mm ± 2.0 mm		BFC2 339 24...		
	Taped ⁽¹⁾	Reel: H = 18.5 mm; P ₀ = 12.7 mm or 15.0 mm		BFC2 339 26...		
		Ammopack: H = 18.5 mm; P ₀ = 12.7 mm		BFC2 339 28...		
	Loose in box	Lead length 3.5 mm + 1 mm/- 0.5 mm or 3.5 mm ± 0.3 mm		± 10 %	BFC2 339 10...	
		Lead length 5.0 mm ± 1.0 mm			BFC2 339 12...	
		Lead length 25.0 mm ± 2.0 mm			BFC2 339 14...	
	Taped ⁽¹⁾	Reel: H = 18.5 mm; P ₀ = 12.7 mm or 15.0 mm			BFC2 339 16...	
		Ammopack: H = 18.5 mm; P ₀ = 12.7 mm	BFC2 339 18...			
	Loose in box	Lead length 3.5 mm + 1 mm/- 0.5 mm or 3.5 mm ± 0.3 mm	± 5 %		BFC2 339 50...	
		Lead length 5.0 mm ± 1.0 mm			BFC2 339 52...	
		Lead length 25.0 mm ± 2.0 mm			BFC2 339 54...	
	Taped ⁽¹⁾	Reel: H = 18.5 mm; P ₀ = 12.7 mm or 15.0 mm			BFC2 339 36...	
		Ammopack: H = 18.5 mm; P ₀ = 12.7 mm		BFC2 339 38...		
		PACKAGING		ALTERNATIVE LARGER PITCH SIZES	C-TOL.	CODE NUMBER
	Loose in box	Lead length 3.5 mm + 1 mm/- 0.5 mm or 3.5 mm ± 0.3 mm		± 20 %	BFC2 339 21...	
		Lead length 5.0 mm ± 1.0 mm			BFC2 339 23...	
		Lead length 25.0 mm ± 2.0 mm			BFC2 339 25...	
	Taped ⁽¹⁾⁽²⁾	Reel or ammpack: H = 18.5 mm; P ₀ = 12.7 mm	BFC2 339 27...			
	Loose in box	Lead length 3.5 mm + 1 mm/- 0.5 mm or 3.5 mm ± 0.3 mm	± 10 %		BFC2 339 11...	
		Lead length 5.0 mm ± 1.0 mm			BFC2 339 13...	
		Lead length 25.0 mm ± 2.0 mm			BFC2 339 15...	
	Taped ⁽¹⁾⁽²⁾	Reel or ammpack: H = 18.5 mm; P ₀ = 12.7 mm			BFC2 339 17...	
Loose in box	Lead length 3.5 mm + 1 mm/- 0.5 mm or 3.5 mm ± 0.3 mm	± 5 %			BFC2 339 51...	
	Lead length 5.0 mm ± 1.0 mm			BFC2 339 53...		
	Lead length 25.0 mm ± 2.0 mm			BFC2 339 55...		
Taped ⁽¹⁾⁽²⁾	Reel: H = 18.5 mm; P ₀ = 12.7 mm or 15.0 mm			BFC2 339 46...		
	Ammopack: H = 18.5 mm; P ₀ = 12.7 mm			BFC2 339 48...		

Notes

- (1) For detailed tape specification refer to "Packaging Information": www.vishay.com/doc?28139
- (2) Taped on reel pitch = 27.5 mm is not available



SPECIFIC REFERENCE DATA		
DESCRIPTION	VALUE	
Rated AC voltage (U_{RAC})	310 V	
Permissible DC voltage (U_{RDC})	630 V	
Tangent of loss angle:	at 1 kHz	at 10 kHz
$C < 470 \text{ nF}$	$\leq 10 \times 10^{-4}$	$\leq 20 \times 10^{-4}$
$470 \text{ nF} \leq C \leq 1 \text{ }\mu\text{F}$	$\leq 20 \times 10^{-4}$	$\leq 70 \times 10^{-4}$
$C > 1 \text{ }\mu\text{F}$	$\leq 30 \times 10^{-4}$	-
Rated voltage pulse slope (dU/dt) _R at 435 V _{DC} :		
Pitch = 7.5 mm	600 V/ μ s	
Pitch = 10 mm	600 V/ μ s	
Pitch = 15 mm	400 V/ μ s	
Pitch = 22.5 mm	150 V/ μ s	
Pitch = 27.5 mm	100 V/ μ s	
R between leads, for $C \leq 0.33 \text{ }\mu\text{F}$ at 100 V; 1 min	> 15 000 M Ω	
RC between leads, for $C > 0.33 \text{ }\mu\text{F}$ at 100 V; 1 min	> 5000 s	
R between leads and case; 100 V; 1 min	> 30 000 M Ω	
Withstanding (DC) voltage (cut off current 10 mA) ⁽¹⁾ ; rise time $\leq 1000 \text{ V/s}$:		
$C \leq 1 \text{ }\mu\text{F}$	2200 V; 1 min	
$C > 1 \text{ }\mu\text{F}$	1800 V; 1 min	
Withstanding (AC) voltage between leads and case	2120 V; 1 min	
Max. application temperature for $0.001 \text{ }\mu\text{F} \leq C \leq 0.47 \text{ }\mu\text{F}$	125 °C up to 1000 h	
Max. application temperature for $C > 0.47 \text{ }\mu\text{F}$	125 °C up to 500 h	

Note

⁽¹⁾ See "Voltage Proof Test for Metalized Film Capacitors": www.vishay.com/doc?28169

ELECTRICAL DATA AND ORDERING INFORMATION - PITCH: 7.5 mm										
U_{RAC} (V)	CAP. (μ F)	DIMENSIONS ⁽¹⁾ w x h x l (mm)	MASS (g) ⁽²⁾	CATALOG NUMBER BFC2 339 XXXXX AND PACKAGING						
				LOOSE IN BOX					AMMOPACK ⁽³⁾	
				SHORT LEADS			LONG LEADS		H = 18.5 mm P ₀ = 12.7 mm	
				$l_t = 3.5 \text{ mm}$ + 1 mm/- 0.5 mm	$l_t = 5.0 \text{ mm}$ $\pm 1.0 \text{ mm}$	SPQ	$l_t = 25.0 \text{ mm}$ $\pm 2.0 \text{ mm}$	SPQ		SPQ
310	PITCH = 7.5 mm \pm 0.4 mm; $d_t = 0.50 \text{ mm} \pm 0.05 \text{ mm}$; C-TOL. = $\pm 20 \%$									
	0.0010			20102	22102		24102		28102	
	0.0015			20152	22152		24152		28152	
	0.0022			20222	22222		24222		28222	
	0.0033			20332	22332		24332		28332	
	0.0047			20472	22472		24472		28472	
	0.0068	4.0 x 9.0 x 10.0	0.4	20682	22682	1500	24682	1000	28682	1250
	0.010			20103	22103		24103		28103	
	0.015			20153	22153		24153		28153	
	0.022			20223	22223		24223		28223	
	0.033			20333	22333		24333		28333	
	0.047	5.0 x 10.5 x 10.0	0.4	20473	22473	1000	24473	1250	28473	1000
	0.068	6.0 x 11.5 x 10.0	0.8	20683	22683	750	24683	1000	28683	750



ELECTRICAL DATA AND ORDERING INFORMATION - PITCH: 7.5 mm											
U _{RAC} (V)	CAP. (µF)	DIMENSIONS ⁽¹⁾ w x h x l (mm)	MASS (g) ⁽²⁾	CATALOG NUMBER BFC2 339 XXXXX AND PACKAGING							
				LOOSE IN BOX					AMMOPACK ⁽³⁾		
				SHORT LEADS			LONG LEADS		H = 18.5 mm P ₀ = 12.7 mm		
				<i>l</i> _t = 3.5 mm + 1 mm/- 0.5 mm	<i>l</i> _t = 5.0 mm ± 1.0 mm	SPQ	<i>l</i> _t = 25.0 mm ± 2.0 mm	SPQ		SPQ	
PITCH = 7.5 mm ± 0.4 mm; d_t = 0.50 mm ± 0.05 mm; C-TOL. = ± 10 %											
310	0.0010	4.0 x 9.0 x 10.0	0.45	10102	12102	1500	14102	1000	18102	1250	
	0.0012			10122	12122		14122		18122		
	0.0015			10152	12152		14152		18152		
	0.0018			10182	12182		14182		18182		
	0.0022			10222	12222		14222		18222		
	0.0027			10272	12272		14272		18272		
	0.0033			10332	12332		14332		18332		
	0.0039			10392	12392		14392		18392		
	0.0047			10472	12472		14472		18472		
	0.0056			10562	12562		14562		18562		
	0.0068			10682	12682		14682		18682		
	0.0082			10822	12822		14822		18822		
	0.010			10103	12103		14103		18103		
	0.012			10123	12123		14123		18123		
	0.015			10153	12153		14153		18153		
	0.018			10183	12183		14183		18183		
	0.022			10223	12223		14223		18223		
	0.027	10273	12273	14273	18273						
	0.033	5.0 x 10.5 x 10.0	0.6	10333	12333	1000	14333	1250	18333	1000	
	0.039			10393	12393		14393		18393		
	0.047			10473	12473		14473		18473		
	0.056	6.0 x 11.5 x 10.0	0.8	10563	12563	750	14563	1000	18563	750	
	PITCH = 7.5 mm ± 0.4 mm; d_t = 0.50 mm ± 0.05 mm; C-TOL. = ± 5 %										
	310	0.0010	4.0 x 9.0 x 10.0	0.45	50102	52102	1500	54102	1000	38102	1250
		0.0012			50122	52122		54122		38122	
		0.0015			50152	52152		54152		38152	
		0.0018			50182	52182		54182		38182	
		0.0022			50222	52222		54222		38222	
		0.0027			50272	52272		54272		38272	
		0.0033			50332	52332		54332		38332	
		0.0039			50392	52392		54392		38392	
		0.0047			50472	52472		54472		38472	
		0.0056			50562	52562		54562		38562	
0.0068		50682			52682	54682		38682			
0.0082		50822			52822	54822		38822			
0.010		50103			52103	54103		38103			
0.012		50123			52123	54123		38123			
0.015		50153			52153	54153		38153			
0.018		50183			52183	54183		38183			
0.022		50223			52223	54223		38223			
0.027		50273	52273	54273	38273						
0.033		5.0 x 10.5 x 10.0	0.6	50333	52333	1000	54333	1250	38333	1000	
0.039				50393	52393		54393		38393		
0.047				50473	52473		54473		38473		
0.056		6.0 x 11.5 x 10.0	0.8	50563	52563	750	54563	1000	38563	750	

Notes

- SPQ = Standard Packing Quantity
- (1) For tolerances see section "Space Requirements for Printed-Circuit Board Applications and Dimension Tolerances"
- (2) Weight for short lead product only
- (3) H = in-tape height; P₀ = sprocket hole distance; for detailed specifications refer to packaging information



ELECTRICAL DATA AND ORDERING INFORMATION - PITCH: 10 mm														
U _{RAC} (V)	CAP. (µF)	DIMENSIONS ⁽¹⁾ w x h x l (mm)	MASS (g) ⁽²⁾	CATALOG NUMBER BFC2 339 XXXX AND PACKAGING										
				LOOSE IN BOX					AMMOPACK ⁽³⁾		LARGE REEL (500 mm) ⁽³⁾⁽⁴⁾			
				SHORT LEADS			LONG LEADS		H = 18.5 mm P ₀ = 12.7 mm		H = 18.5 mm P ₀ = 12.7 mm			
				l _t = 3.5 mm + 1 mm/- 0.5 mm	l _t = 5.0 mm ± 1.0 mm	SPQ	l _t = 25.0 mm ± 2.0 mm	SPQ		SPQ		SPQ		
PITCH = 10.0 mm ± 0.4 mm; d _t = 0.60 mm ± 0.06 mm; C-TOL. = ± 20 %														
310	0.0010	4.0 x 10.0 x 12.5	0.6	21102	23102		25102		27102					
	0.0015			21152	23152		25152		27152					
	0.0022			21222	23222		25222		27222					
	0.0033			21332	23332		25332		27332					
	0.0047			21472	23472		25472		27472					
	0.0068			21682	23682	1000	25682	1250	27682	950	-	-		
	0.010			21103	23103		25103		27103					
	0.015			21153	23153		25153		27153					
	0.022			21223	23223		25223		27223					
	0.033			21333	23333		25333		27333					
	0.047			21473	23473		25473		27473					
	0.068			5.0 x 11.0 x 12.5	0.82	21683	23683	1000	25683	1000	27683	750	-	-
	0.100			6.0 x 12.0 x 12.5	1.1	20104	22104	750	24104	750	28104	600	26104	900
PITCH = 10.0 mm ± 0.4 mm; d _t = 0.60 mm ± 0.06 mm; C-TOL. = ± 10 %														
310	0.0010	4.0 x 10.0 x 12.5	0.6	11102	13102		15102		17102					
	0.0012			11122	13122		15122		17122					
	0.0015			11152	13152		15152		17152					
	0.0018			11182	13182		15182		17182					
	0.0022			11222	13222		15222		17222					
	0.0027			11272	13272		15272		17272					
	0.0033			11332	13332		15332		17332					
	0.0039			11392	13392		15392		17392					
	0.0047			11472	13472		15472		17472					
	0.0056			11562	13562		15562		17562					
	0.0068			11682	13682	1000	15682	1250	17682	950	-	-		
	0.0082			11822	13822		15822		17822					
	0.010			11103	13103		15103		17103					
	0.012			11123	13123		15123		17123					
	0.015			11153	13153		15153		17153					
	0.018			11183	13183		15183		17183					
	0.022			11223	13223		15223		17223					
	0.027			11273	13273		15273		17273					
	0.033			11333	13333		15333		17333					
	0.039			11393	13393		15393		17393					
	0.047			11473	13473		15473		17473					
0.056	5.0 x 11.0 x 12.5	0.82	11563	13563	1000	15563	1000	17563	750	-	-			
0.068			10683	12683		14683		18683		16683	1100			
0.082	6.0 x 12.0 x 12.5	1.1	10823	12823	750	14823	750	18823	600	16823	900			
0.100			10104	12104		14104		18104		16104	900			



ELECTRICAL DATA AND ORDERING INFORMATION - PITCH: 10 mm												
U _{RAC} (V)	CAP. (μF)	DIMENSIONS ⁽¹⁾ w x h x l (mm)	MASS (g) ⁽²⁾	CATALOG NUMBER BFC2 339 XXXX AND PACKAGING								
				LOOSE IN BOX					AMMOPACK ⁽³⁾		LARGE REEL (500 mm) ⁽³⁾⁽⁴⁾	
				SHORT LEADS			LONG LEADS		H = 18.5 mm P ₀ = 12.7 mm		H = 18.5 mm P ₀ = 12.7 mm	
				l _t = 3.5 mm + 1 mm/- 0.5 mm	l _t = 5.0 mm ± 1.0 mm	SPQ	l _t = 25.0 mm ± 2.0 mm	SPQ		SPQ		SPQ
PITCH = 10.0 mm ± 0.4 mm; d _t = 0.60 mm ± 0.06 mm; C-TOL. = ± 5 %												
310	0.0010	4.0 x 10.0 x 12.5	0.6	51102	53102		55102		48102			
	0.0012			51122	53122		55122		48122			
	0.0015			51152	53152		55152		48152			
	0.0018			51182	53182		55182		48182			
	0.0022			51222	53222		55222		48222			
	0.0027			51272	53272		55272		48272			
	0.0033			51332	53332		55332		48332			
	0.0039			51392	53392		55392		48392			
	0.0047			51472	53472		55472		48472			
	0.0056			51562	53562		55562		48562			
	0.0068			51682	53682	1000	55682	1250	48682	950	-	-
	0.0082			51822	53822		55822		48822			
	0.010			51103	53103		55103		48103			
	0.012			51123	53123		55123		48123			
	0.015			51153	53153		55153		48153			
	0.018			51183	53183		55183		48183			
	0.022			51223	53223		55223		48223			
	0.027			51273	53273		55273		48273			
	0.033			51333	53333		55333		48333			
	0.039			51393	53393		55393		48393			
0.047	51473	53473		55473		48473						
0.056	5.0 x 11.0 x 12.5	0.82	51563	53563	1000	55563	1000	48563	750	46563	1100	
0.068			50683	52683		54683		38683		36683		
0.082	6.0 x 12.0 x 12.5	1.1	50823	52823	750	54823	750	38823	600	36823	900	

Notes

- SPQ = Standard Packing Quantity
- (1) For tolerances see section "Space Requirements for Printed-Circuit Board Applications and Dimension Tolerances"
- (2) Weight for short lead product only
- (3) H = in-tape height; P₀ = sprocket hole distance; for detailed specifications refer to packaging information
- (4) Reel diameter = 356 mm is available on request



ELECTRICAL DATA AND ORDERING INFORMATION - PITCH: 15 mm											
U _{RAC} (V)	CAP. (µF)	DIMENSIONS ⁽¹⁾ w x h x l (mm)	MASS (g) ⁽²⁾	CATALOG NUMBER BFC2 339 XXXXX AND PACKAGING							
				LOOSE IN BOX					LARGE REEL (500 mm) ⁽³⁾⁽⁴⁾		
				SHORT LEADS			LONG LEADS		H = 18.5 mm P ₀ = 12.7 mm		
				l _t = 3.5 mm ± 0.3 mm	l _t = 5.0 mm ± 1.0 mm	SPQ	l _t = 25.0 mm ± 2.0 mm	SPQ		SPQ	
PITCH = 15 mm ± 0.4 mm; d_t = 0.60 mm ± 0.06 mm; C-TOL. = ± 20 %											
310	0.010	5.0 x 11.0 x 17.5	1	90001	90007	1250	90014	1000	90021	1100	
	0.015			90002	90008		90015		90022		
	0.022			90003	90009		90016		90023		
	0.033			90004	90011		90017		90024		
	0.047			90005	90012		90018		90025		
	0.068			90006	90013		90019		90026		
	0.10			21104	23104		25104		27104		
	0.15	6.0 x 12.0 x 17.5	1.4	20154	22154	1000	24154	1000	26154	900	
	PITCH = 15 mm ± 0.4 mm; d_t = 0.80 mm ± 0.08 mm; C-TOL. = ± 20 %										
	0.22	7.0 x 13.5 x 17.5	1.8	20224	22224	750	24224	500	26224	800	
0.33	8.5 x 15.0 x 17.5	2.4	20334	22334	750	24334	500	26334	650		
0.47	10.0 x 16.5 x 17.5	3.0	20474	22474	500	24474	450	26474	600		
	8.5 x 17.5 x 18.0	3.1	90165	90166	300	90143	500	-	-		
0.56	11.0 x 18.5 x 18.0	4.3	90174	90175	225	90176	350	-	-		
0.68	11.0 x 18.5 x 18.0	5.5	90168	90169	225	90145	350	-	-		
PITCH = 15 mm ± 0.4 mm; d_t = 0.60 mm ± 0.06 mm; C-TOL. = ± 10 %											
310	0.010	5.0 x 11.0 x 17.5	1.0	90027	90039	1250	90052	1000	90064	1100	
	0.012			90028	90041		90053		90065		
	0.015			90029	90042		90054		90066		
	0.018			90031	90043		90055		90067		
	0.022			90032	90044		90056		90068		
	0.027			90033	90045		90057		90069		
	0.033			90034	90046		90058		90071		
	0.039			90035	90047		90059		90072		
	0.047			90036	90048		90061		90073		
	0.056			90037	90049		90062		90074		
	0.068			11683	13683		15683		17683		
	0.082			11823	13823		15823		17823		
	0.100			11104	13104		15104		17104		
	0.12	6.0 x 12.0 x 17.5	1.4	10124	12124	1000	14124	1000	16124	900	
	0.15			10154	12154		14154		16154		
PITCH = 15 mm ± 0.4 mm; d_t = 0.80 mm ± 0.08 mm; C-TOL. = ± 10 %											
0.18	7.0 x 13.5 x 17.5	1.8	10184	12184	750	14184	500	16184	800		
0.22			10224	12224		14224		16224			
0.27	8.5 x 15.0 x 17.5	2.4	10274	12274	750	14274	500	16274	650		
0.33			10334	12334		14334		16334			
0.39	10.0 x 16.5 x 17.5	3.0	10394	12394	500	14394	450	16394	600		
0.47			10474	12474		14474		16474			
0.56	11.0 x 18.5 x 18.0	4.3	90167	90157	225	90144	400	-	-		



ELECTRICAL DATA AND ORDERING INFORMATION - PITCH: 15 mm										
U _{RAC} (V)	CAP. (μF)	DIMENSIONS ⁽¹⁾ w x h x l (mm)	MASS (g) ⁽²⁾	CATALOG NUMBER BFC2 339 XXXXX AND PACKAGING						
				LOOSE IN BOX					LARGE REEL (500 mm) ⁽³⁾⁽⁴⁾	
				SHORT LEADS			LONG LEADS		H = 18.5 mm P ₀ = 12.7 mm	
				l _t = 3.5 mm ± 0.3 mm	l _t = 5.0 mm ± 1.0 mm	SPQ	l _t = 25.0 mm ± 2.0 mm	SPQ		SPQ
PITCH = 15 mm ± 0.4 mm; d _t = 0.60 mm ± 0.06 mm; C-TOL. = ± 5 %										
310	0.010	5.0 x 11.0 x 17.5	1.0	90221	90232	1250	90243	1000	90254	1100
	0.012			90222	90233		90244		90255	
	0.015			90223	90234		90245		90256	
	0.018			90224	90235		90246		90257	
	0.022			90225	90236		90247		90258	
	0.027			90226	90237		90248		90259	
	0.033			90227	90238		90249		90261	
	0.039			90228	90239		90251		90262	
	0.047			90229	90241		90252		90263	
	0.056			90231	90242		90253		90264	
	0.068	51683	53683	55683	46683					
	0.082	51823	53823	55823	46823					
	0.10	50104	52104	54104	36104					
0.12	6.0 x 12.0 x 17.5	1.4	50124	52124	1000	54124	1000	36124	900	
0.15			50154	52154		54154		36154		
PITCH = 15 mm ± 0.4 mm; d _t = 0.80 mm ± 0.08 mm; C-TOL. = ± 5 %										
	0.18	7.0 x 13.5 x 17.5	1.8	50184	52184	750	54184	500	36184	800
	0.22	8.5 x 15.0 x 17.5	2.4	50224	52224	750	54224	500	36224	650
	0.27			50274	52274		54274		36274	
	0.33			50334	52334		54334		36334	
	0.39	10.0 x 16.5 x 17.5	3.0	50394	52394	500	54394	450	36394	600

Notes

- SPQ = Standard Packing Quantity
- (1) For tolerances see section "Space Requirements for Printed-Circuit Board Applications and Dimension Tolerances"
- (2) Weight for short lead product only
- (3) H = in-tape height; P₀ = sprocket hole distance; for detailed specifications refer to packaging information
- (4) Reel diameter = 356 mm is available on request

ELECTRICAL DATA AND ORDERING INFORMATION - PITCH: 22.5 mm										
U _{RAC} (V)	CAP. (μF)	DIMENSIONS ⁽¹⁾ w x h x l (mm)	MASS (g) ⁽²⁾	CATALOG NUMBER BFC2 339 XXXXX AND PACKAGING						
				LOOSE IN BOX					LARGE REEL (500 mm) ⁽³⁾⁽⁴⁾	
				SHORT LEADS			LONG LEADS		H = 18.5 mm P ₀ = 12.7 mm	
				l _t = 3.5 mm ± 0.3 mm	l _t = 5.0 mm ± 1.0 mm	SPQ	l _t = 25.0 mm ± 2.0 mm	SPQ		SPQ
PITCH = 22.5 mm ± 0.4 mm; d _t = 0.80 mm ± 0.08 mm; C-TOL. = ± 20 %										
310	0.15	6.0 x 15.5 x 26.0	2.4	21154	23154	300	25154	250	27154	600
	0.22			21224	23224		25224		27224	
	0.33			21334	23334		25334		27334	
	0.47	7.0 x 16.5 x 26.0	2.9	21474	23474	200	25474	250	27474	500
	0.68	8.5 x 18.0 x 26.0	3.8	20684	22684	200	24684	250	26684	450
	1.0	10.0 x 19.5 x 26.0	6.8	20105	22105	200	24105	200	26105	350
	1.5	12.5 x 22.5 x 26.5	10	90103	90138	140	90139	400	90141	300



ELECTRICAL DATA AND ORDERING INFORMATION - PITCH: 22.5 mm											
U _{RAC} (V)	CAP. (μF)	DIMENSIONS ⁽¹⁾ w x h x l (mm)	MASS (g) ⁽²⁾	CATALOG NUMBER BFC2 339 XXXXX AND PACKAGING							
				LOOSE IN BOX					LARGE REEL (500 mm) ⁽³⁾⁽⁴⁾		
				SHORT LEADS			LONG LEADS		H = 18.5 mm P ₀ = 12.7 mm		
				l _t = 3.5 mm ± 0.3 mm	l _t = 5.0 mm ± 1.0 mm	SPQ	l _t = 25.0 mm ± 2.0 mm	SPQ		SPQ	
PITCH = 22.5 mm ± 0.4 mm; d _t = 0.80 mm ± 0.08 mm; C-TOL. = ± 10 %											
310	0.12	6.0 x 15.5 x 26.0	2.4	11124	13124	300	15124	250	17124	600	
	0.15			11154	13154		15154		17154		
	0.18			11184	13184		15184		17184		
	0.22			11224	13224		15224		17224		
	0.27			11274	13274		15274		17274		
	0.33			11334	13334		15334		17334		
	0.33	8.5 x 14.0 x 26.5	3.6	-	-	-	75334	800	-	-	
	0.39	7.0 x 16.5 x 26.0	2.9	11394	13394	200	15394	250	17394	500	
	0.47			11474	13474		15474		17474		
	0.47	8.5 x 14.0 x 26.5	3.6	-	-	-	75474	800	-	-	
	0.56	8.5 x 18.0 x 26.0	3.8	10564	12564	200	14564	250	16564	450	
	0.68	10.0 x 19.5 x 26.0	6.8	10684	12684	200	14684	200	16684	350	
	0.82			10824	12824		14824		16824		
	1.0	12.0 x 22.0 x 26.0	7.8	10105	12105	150	14105	200	16105	300	
	PITCH = 22.5 mm ± 0.4 mm; d _t = 0.80 mm ± 0.08 mm; C-TOL. = ± 5 %										
	310	0.12	6.0 x 15.5 x 26.0	2.4	51124	53124	300	55124	250	46124	600
		0.15			51154	53154		55154		46154	
		0.18			51184	53184		55184		46184	
		0.22			51224	53224		55224		46224	
		0.27			51274	53274		55274		46274	
0.33		51334			53334	55334		46334			
0.39		7.0 x 16.5 x 26.0	2.9	51394	53394	200	55394	250	46394	500	
0.47		8.5 x 18.0 x 26.0	3.8	51474	53474	200	55474	250	46474	450	
0.56				50564	52564		54564		36564		
0.68		10.0 x 19.5 x 26.0	6.8	50684	52684	200	54684	200	36684	350	
0.82				50824	52824		54824		36824		
1.0		12.0 x 22.0 x 26.0	7.8	50105	52105	150	54105	200	36105	300	

Notes

- SPQ = Standard Packing Quantity
- (1) For tolerances see section "Space Requirements for Printed-Circuit Board Applications and Dimension Tolerances"
- (2) Weight for short lead product only
- (3) H = in-tape height; P₀ = sprocket hole distance; for detailed specifications refer to packaging information
- (4) Reel diameter = 356 mm is available on request



ELECTRICAL DATA AND ORDERING INFORMATION - PITCH: 27.5 mm									
U _{RAC} (V)	CAP. (μF)	DIMENSIONS ⁽¹⁾ w x h x l (mm)	MASS (g) ⁽²⁾	CATALOG NUMBER BFC2 339 XXXXX AND PACKAGING					
				LOOSE IN BOX					
				SHORT LEADS			LONG LEADS		
				l _t = 3.5 mm ± 0.3 mm		l _t = 5.0 mm ± 1.0 mm	SPQ	l _t = 25.0 mm ± 2.0 mm	SPQ
PITCH = 27.5 mm ± 0.4 mm; d_t = 0.80 mm ± 0.08 mm; C-TOL. = ± 20 %									
310	0.47	9.0 x 19.0 x 31.5	5.5	90076	90078	100	90081	150	
	0.68			21684	23684		25684		
	1.0	11.0 x 21.0 x 31.0	7.4	21105	23105	100	25105	125	
	1.5	13.0 x 23.0 x 31.0	9.2	20155	22155	100	24155	125	
	2.2	15.0 x 25.0 x 31.5	12.3	20225	22225	100	24225	125	
	3.3	18.0 x 28.0 x 31.5	16.1	20335	22335	100	24335	100	
	4.7	21.0 x 31.0 x 31.0	20.3	20475	22475	50	24475	75	
	PITCH = 27.5 mm ± 0.4 mm; d_t = 0.80 mm ± 0.08 mm; C-TOL. = ± 10 %								
	0.68	9.0 x 19.0 x 31.5	5.5	11684	13684	100	15684	150	
	0.82	11.0 x 21.0 x 31.0	7.4	11824	13824	100	15824	125	
	1.0			11105	13105		15105		
	1.2			10125	12125		14125		
	1.5	13.0 x 23.0 x 31.0	9.2	10155	12155	100	14155	125	
	1.8	15.0 x 25.0 x 31.5	12.3	10185	12185	100	14185	125	
	2.2			10225	12225		14225		
	2.7	18.0 x 28.0 x 31.5	16.1	10275	12275	100	14275	100	
	3.3	21.0 x 31.0 x 31.0	20.3	10335	12335	50	14335	75	
	3.9			10395	12395		14395		
	PITCH = 27.5 mm ± 0.4 mm; d_t = 0.80 mm ± 0.08 mm; C-TOL. = ± 5 %								
	0.68	9.0 x 19.0 x 31.5	5.5	51684	53684	100	55684	150	
	0.82	11.0 x 21.0 x 31.0	7.4	51824	53824	100	55824	125	
	1.0			51105	53105		55105		
	1.2	13.0 x 23.0 x 31.0	9.2	50125	52125	100	54125	125	
	1.5			50155	52155		54155		
1.8	15.0 x 25.0 x 31.5	12.3	50185	52185	100	54185	125		
2.2	18.0 x 28.0 x 31.5	16.1	50225	52225	100	54225	100		
2.7			50275	52275		54275			
3.3	21.0 x 31.0 x 31.0	20.3	50335	52335	50	54335	75		

Notes

• SPQ = Standard Packing Quantity

(1) For tolerances see section "Space Requirements for Printed-Circuit Board Applications and Dimension Tolerances"

(2) Weight for short lead product only

APPROVALS				
SAFETY APPROVALS X2	VOLTAGE	VALUE	FILE NUMBERS	LINK
EN 60384-14 (ENEC) (= IEC 60384-14 ed-4 (2013))	310 V _{AC}	1 nF to 4.7 μF	ENEC16/FI/21/01054/A2	www.vishay.com/doc?28179
UL 60384-14	310 V _{AC}	1 nF to 4.7 μF	E354331	www.vishay.com/doc?28184
CSA-E384-14	310 V _{AC}	1 nF to 4.7 μF	E354331	
CQC	310 V _{AC}	1 nF to 4.7 μF	CQC 07001021281 (L)	www.vishay.com/doc?28180
			CQC 06001018290 (F)	www.vishay.com/doc?28181
CB test certificate	310 V _{AC}	1 nF to 4.7 μF	FI-39827/A1	www.vishay.com/doc?28175
The ENEC-approval together with the CB-certificate replace all national marks of the following countries (they have already signed the ENEC-agreement): Austria; Belgium; Czech. Republic; Denmark; Finland; France; Germany; Greece; Hungary; Ireland; Italy; Luxembourg; Netherlands; Norway; Portugal; Slovenian; Spain; Sweden; Switzerland and United Kingdom.				

MOUNTING

Normal Use

The capacitors are designed for mounting on printed circuit boards. The capacitors packed in bandoliers are designed for mounting in printed-circuit boards by means of automatic insertion machines.

For detailed tape specifications refer to “Packaging Information” www.vishay.com/doc?28139 or end of catalog.

Specific Method of Mounting to Withstand Vibration and Shock

In order to withstand vibration and shock tests, it must be insured that the stand-off pips are in good contact with the printed-circuit board:

- For pitches ≤ 15 mm capacitors shall be mechanically fixed by the leads.
- For larger pitches the capacitors shall be mounted in the same way and the body clamped.

Space Requirements for Printed-Circuit Board Applications and Dimension Tolerances

The maximum space for length ($l_{max.}$), width ($w_{max.}$), and height ($h_{max.}$) of film capacitors to take in account on the printed circuit board is shown in the drawings:

- For products with pitch ≤ 15 mm, $\Delta w = \Delta l = 0.3$ mm, $\Delta h = 0.1$ mm
- For products with 15 mm $<$ pitch ≤ 27.5 mm, $\Delta w = \Delta l = 0.5$ mm, $\Delta h = 0.1$ mm

Eccentricity defined as in drawing. The maximum eccentricity is smaller than or equal to the lead diameter of the product concerned.

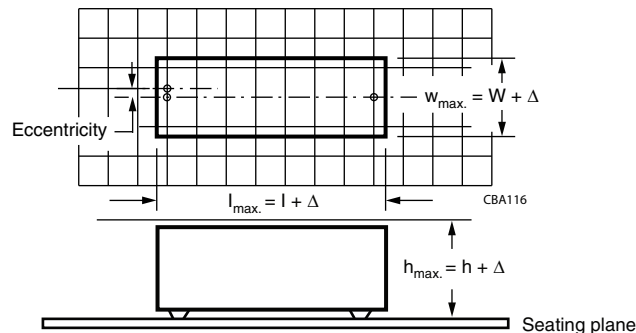

For the minimum product dimensions for length ($l_{min.}$), width ($w_{min.}$), and height ($h_{min.}$) following tolerances of the components are valid:

$l_{min.} = l - \Delta l$, $w_{min.} = w - \Delta w$ and $h_{min.} = h - \Delta h$ following

- For products with pitch ≤ 10 mm, $\Delta l = 0.3$ mm and $\Delta w = \Delta h = 0.3$ mm
- For products with pitch = 15 mm, $\Delta l = 0.5$ mm and $\Delta w = \Delta h = 0.5$ mm
- For products with 15 mm $<$ pitch ≤ 27.5 mm, $\Delta l = 1.0$ mm and $\Delta w = \Delta h = 0.5$ mm



SOLDERING CONDITIONS

For general soldering conditions and wave soldering profile, we refer to the application note: "Soldering Guidelines for Film Capacitors": www.vishay.com/doc?28171

Storage Temperature

T_{stg} = -25 °C to +35 °C, RH maximum 75 % without condensation

Ratings and Characteristics Reference Conditions

Unless otherwise specified, all electrical values apply to an ambient temperature of 23 °C ± 1 °C, an atmospheric pressure of 86 kPa to 106 kPa and a relative humidity of 50 % ± 2 %.

For reference testing, a conditioning period shall be applied over 96 h ± 4 h by heating the products in a circulating air oven at the rated temperature and a relative humidity not exceeding 20 %.

CHARACTERISTICS

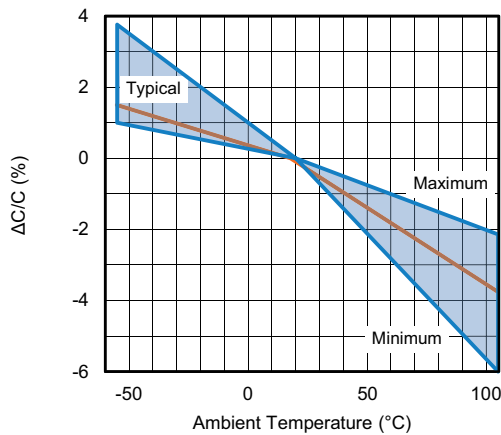

Capacitance as a function of ambient temperature (typical curve)

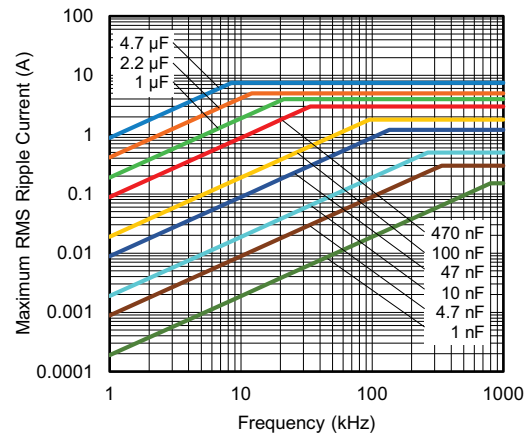

Maximum RMS current as a function of frequency

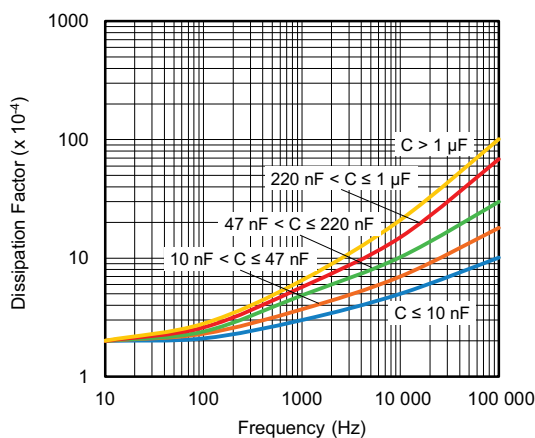

Tangent of loss angle as a function of frequency (typical curve)

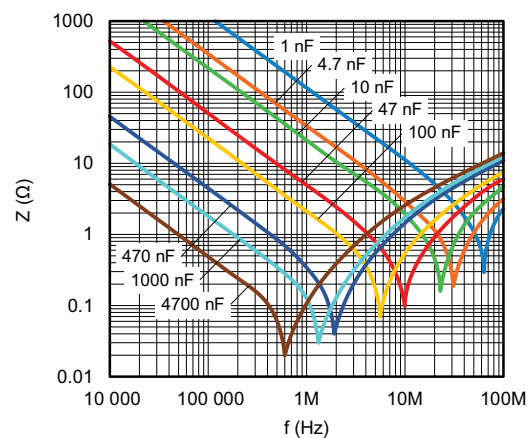

Impedance as a function of frequency (typical curve)

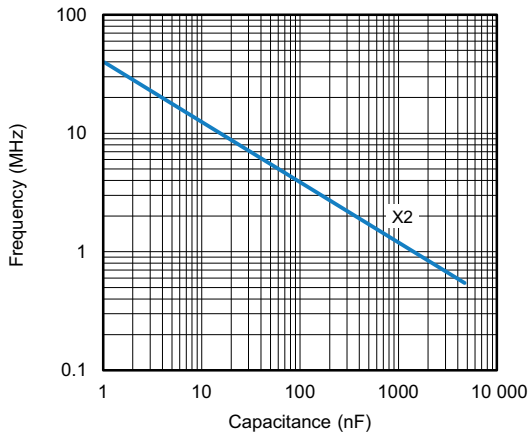

Resonant frequency as a function of capacitance (typical curve)

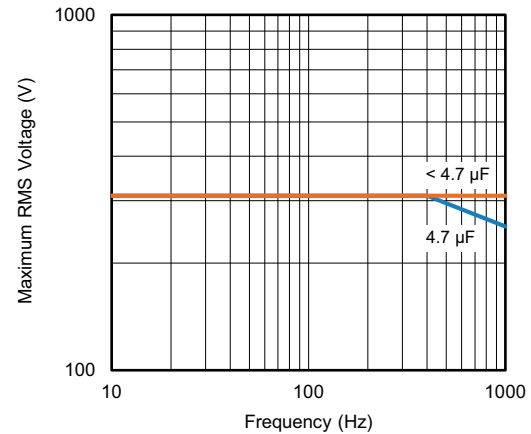

Maximum RMS voltage as a function of frequency

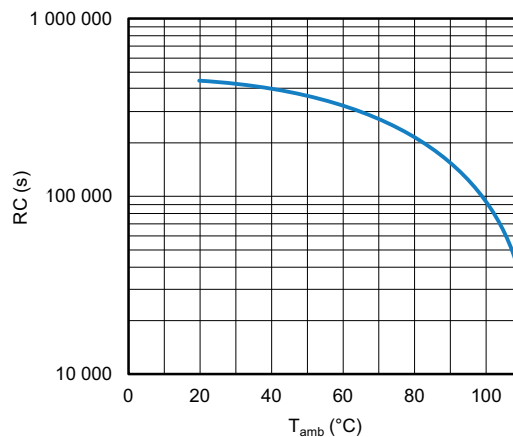

Insulation resistance as a function of ambient temperature (typical curve)

APPLICATION NOTES

- For X2 electromagnetic interference suppression in **standard across the line applications** (50 Hz / 60 Hz) with a maximum mains voltage of 310 V_{AC}
- For series impedance applications we refer to application note www.vishay.com/doc?28153
- For capacitors connected in parallel, normally the proof voltage and possibly the rated voltage must be reduced. For information depending of the capacitance value and the number of parallel connections contact: rfi@vishay.com
- These capacitors are not intended for continuous pulse application. For these situations capacitors of the AC and pulse programs must be used
- The maximum ambient temperature must not exceed 110 °C (125 °C for less than 1000 h) for C ≤ 470 nF and 110 °C for C > 470 nF
- Rated voltage pulse slope:
If the pulse voltage is lower than the rated voltage, the values of the specific reference data can be multiplied by 435 V_{DC} and divided by the applied voltage



INSPECTION REQUIREMENTS

General Notes

Sub-clause numbers of tests and performance requirements refer to the "Sectional Specification, publication IEC 60384-14 ed-4 (2013) and Specific Reference Data.

GROUP C INSPECTION REQUIREMENTS		
SUB-CLAUSE NUMBER AND TEST	CONDITIONS	PERFORMANCE REQUIREMENTS
SUB-GROUP C1A PART OF SAMPLE OF SUB-GROUP C1		
4.1 Dimensions (detail) Initial measurements	Capacitance Tangent of loss angle: For C ≤ 1 μF at 10 kHz For C > 1 μF at 1 kHz	As specified in section "General data" of this specification
4.3 Robustness of terminations	Tensile: load 10 N; 10 s Bending: load 5 N; 4 x 90°	No visible damage
4.4 Resistance to soldering heat	No pre-drying Method: 1A Solder bath: 280 °C ± 5 °C Duration: 10 s	
4.19 Component solvent resistance	Isopropylalcohol at room temperature Method: 2 Immersion time: 5 min ± 0.5 min Recovery time: Min. 1 h, max. 2 h	
4.4.2 Final measurements	Visual examination Capacitance Tangent of loss angle Insulation resistance	No visible damage Legible marking ΔC/C ≤ 5 % of the value measured initially. Increase of tan δ: ≤ 0.008 for: C ≤ 1 μF or ≤ 0.005 for: C > 1 μF Compared to values measured initially As specified in section "Insulation Resistance" of this specification
SUB-GROUP C1B PART OF SAMPLE OF SUB-GROUP C1		
Initial measurements	Capacitance Tangent of loss angle: For C ≤ 1 μF at 10 kHz For C > 1 μF at 1 kHz	
4.20 Solvent resistance of the marking	Isopropylalcohol at room temperature Method: 1 Rubbing material: Cotton wool Immersion time: 5 min ± 0.5 min	No visible damage Legible marking



GROUP C INSPECTION REQUIREMENTS		
SUB-CLAUSE NUMBER AND TEST	CONDITIONS	PERFORMANCE REQUIREMENTS
SUB-GROUP C1B PART OF SAMPLE OF SUB-GROUP C1		
4.6 Rapid change of temperature	<p>θA = -55 °C θB = +110 °C 5 cycles Duration t = 30 min</p>	
4.6.1 Inspection	Visual examination	No visible damage
4.7 Vibration	<p>Mounting: see section "Mounting" of this specification Procedure B4 Frequency range: 10 Hz to 55 Hz Amplitude: 0.75 mm or acceleration 98 m/s² (whichever is less severe) Total duration 6 h</p>	
4.7.2 Final inspection	Visual examination	No visible damage
4.9 Shock	<p>Mounting: see section "Mounting" for more information Pulse shape: half sine Acceleration: 490 m/s² Duration of pulse: 11 ms</p>	
4.9.2 Final measurements	<p>Visual examination</p> <p>Capacitance</p> <p>Tangent of loss angle</p> <p>Insulation resistance</p>	<p>No visible damage</p> <p>$\Delta C/C \leq 5\%$ of the value measured initially.</p> <p>Increase of tan δ: ≤ 0.008 for: $C \leq 1 \mu\text{F}$ or ≤ 0.005 for: $C > 1 \mu\text{F}$ Compared to values measured initially</p> <p>As specified in section "Insulation Resistance" of this specification</p>
SUB-GROUP C1 COMBINED SAMPLE OF SPECIMENS OF SUB-GROUPS C1A AND C1B		
4.11 Climatic sequence		
4.11.1 Initial measurements	<p>Capacitance Measured in 4.4.2 and 4.9.2 Tangent of loss angle: Measured initially in C1A and C1B</p>	
4.11.2 Dry heat	Temperature: 110 °C	
4.11.3 Damp heat cyclic Test Db First cycle	Duration: 16 h	
4.11.4 Cold	Temperature: -55 °C	
4.11.5 Damp heat cyclic Test Db remaining cycles	Duration: 2 h	



GROUP C INSPECTION REQUIREMENTS		
SUB-CLAUSE NUMBER AND TEST	CONDITIONS	PERFORMANCE REQUIREMENTS
SUB-GROUP C1 COMBINED SAMPLE OF SPECIMENS OF SUB-GROUPS C1A AND C1B		
4.11.6 Final measurements	Visual examination Capacitance Tangent of loss angle Voltage proof 1350 V _{DC} ; 1 min between terminations Insulation resistance	No visible damage Legible marking $ \Delta C/C \leq 5\%$ of the value measured in 4.11.1. Increase of tan δ : ≤ 0.008 for: C $\leq 1 \mu\text{F}$ or ≤ 0.005 for: C $> 1 \mu\text{F}$ Compared to values measured in 4.11.1. No permanent breakdown or flash-over $\geq 50\%$ of values specified in section "Insulation Resistance" of this specification
SUB-GROUP C2		
4.12 Damp heat steady state	56 days; 40 °C; 90 % to 95 % RH no load	
4.12.1 Initial measurements	Capacitance Tangent of loss angle: at 1 kHz	
4.12.3 Final measurements	Visual examination Capacitance Tangent of loss angle Voltage proof 1350 V _{DC} ; 1 min between terminations Insulation resistance	No visible damage Legible marking $ \Delta C/C \leq 5\%$ of the value measured in 4.12.1 Increase of tan δ : ≤ 0.008 for: C $\leq 1 \mu\text{F}$ or ≤ 0.005 for: C $> 1 \mu\text{F}$ Compared to values measured in 4.12.1 No permanent breakdown or flash-over $\geq 50\%$ of values specified in section "Insulation Resistance" of this specification
SUB-GROUP C3		
4.13.1 Initial measurements	Capacitance Tangent of loss angle: For C $\leq 1 \mu\text{F}$ at 10 kHz For C $> 1 \mu\text{F}$ at 1 kHz	
4.13 Impulse voltage	3 successive impulses, full wave, peak voltage: X2: 2.5 kV for C $\leq 1 \mu\text{F}$ X2: 2.5 kV/ \sqrt{C} for C $> 1 \mu\text{F}$ Max. 24 pulses	No self healing breakdowns or flash-over

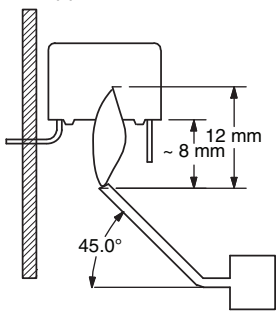

GROUP C INSPECTION REQUIREMENTS		
SUB-CLAUSE NUMBER AND TEST	CONDITIONS	PERFORMANCE REQUIREMENTS
SUB-GROUP C3		
4.14 Endurance	Duration: 1000 h 1.25 x U _{RAC} at 110 °C Once in every hour the voltage is increased to 1000 V _{RMS} for 0.1 s via resistor of 47 Ω ± 5 %	
4.14.7 Final measurements	Visual examination Capacitance Tangent of loss angle Voltage proof 1350 V _{DC} ; 1 min between terminations 2120 V _{AC} ; 1 min between terminations and case Insulation resistance	No visible damage Legible marking ΔC/C ≤ 10 % compared to values measured in 4.13.1 Increase of tan δ: ≤ 0.008 for: C ≤ 1 μF or ≤ 0.005 for: C > 1 μF Compared to values measured in 4.13.1 No permanent breakdown or flash-over ≥ 50 % of values specified in section “Insulation Resistance” of this specification
SUB-GROUP C4		
4.15 Charge and discharge	10 000 cycles charged to 435 V _{DC} Discharge resistance: $R = \frac{435 V_{DC}}{1.25 \times C (dU/dt)}$	
4.15.1 Initial measurements	Capacitance Tangent of loss angle: For C ≤ 1 μF at 10 kHz For C > 1 μF at 1 kHz	
4.15.3 Final measurements	Capacitance Tangent of loss angle Insulation resistance	ΔC/C ≤ 10 % compared to values measured in 4.15.1. Increase of tan δ: ≤ 0.008 for: C ≤ 1 μF or ≤ 0.005 for: C > 1 μF Compared to values measured in 4.15.1 ≥ 50 % of values specified in section “Insulation Resistance” of this specification
SUB-GROUP C5		
4.16 Radio frequency characteristic	Resonance frequency	≥ 0.9 times the value as specified in section “Resonant Frequency” of this specification.

GROUP C INSPECTION REQUIREMENTS		
SUB-CLAUSE NUMBER AND TEST	CONDITIONS	PERFORMANCE REQUIREMENTS
SUB-GROUP C6		
4.17 Passive flammability Class B	Bore of gas jet: \varnothing 0.5 mm Fuel: butane Test duration for actual volume V in mm ³ : $V \leq 250$: 10 s $250 < V \leq 500$: 20 s $500 < V \leq 1750$: 30 s $V > 1750$: 60 s One flame application 	After removing test flame from capacitor, the capacitor must not continue to burn for more than 10 s. No burning particle must drop from the sample.
SUB-GROUP C7		
4.18 Active flammability	20 cycles of 2.5 kV discharges on the test capacitor connected to U_{RAC}	The cheese cloth around the capacitors shall not burn with a flame. No electrical measurements are required.
SUB-GROUP ADD 6		
A.6 Endurance	Duration: 1000 h for $C \leq 0.47 \mu\text{F}$ 500 h for $C > 0.47 \mu\text{F}$ $1.0 \times U_{RAC}$ at 125 °C	
A.6.1 Initial measurements	Capacitance Tangent of loss angle: for $C \leq 1 \mu\text{F}$ at 10 kHz for $C > 1 \mu\text{F}$ at 1 kHz	
A.6.2 Final measurements	Visual examination Capacitance Tangent of loss angle Insulation resistance.	No visible damage Legible marking $ \Delta C/C \leq 10\%$ of the value measured in A.6.1 Increase of $\tan \delta$: ≤ 0.008 for: $C \leq 1 \mu\text{F}$ or ≤ 0.005 for: $C > 1 \mu\text{F}$ Compared to values measured in A.6.1 $\geq 50\%$ of values specified in section "Insulation resistance" of this specification
SUB-GROUP ADD 7		
A.7 Endurance	Duration: 500 h $0.625 \times U_{RDC}$ at 125 °C	
A.7.1 Initial measurements	Capacitance Tangent of loss angle: for $C \leq 1 \mu\text{F}$ at 10 kHz for $C > 1 \mu\text{F}$ at 1 kHz	



GROUP C INSPECTION REQUIREMENTS		
SUB-CLAUSE NUMBER AND TEST	CONDITIONS	PERFORMANCE REQUIREMENTS
SUB-GROUP ADD 7		
A.7.2 Final measurements	Visual examination Capacitance Tangent of loss angle Insulation resistance	No visible damage Legible marking $ \Delta C/C \leq 10\%$ of the value measured in A.7.1 Increase of $\tan \delta$: ≤ 0.008 for: $C \leq 1 \mu F$ or ≤ 0.005 for: $C > 1 \mu F$ Compared to values measured in A.7.1 $\geq 50\%$ of values specified in section "Insulation resistance" of this specification
SUB-GROUP ADD8		
A.8 Damp heat steady state with voltage	RH: 40 %; temp.: 93 °C, voltage: 310 V _{AC} Duration: 21 days	
A.8.1 Initial measurements	Capacitance Tangent of loss angle: at 10 kHz	
A.8.2 Final measurements	Visual examination Capacitance Tangent of loss angle Insulation resistance	No visible damage Legible marking $ \Delta C/C \leq 10\%$ of the value with initial measurement A.8.1 Increase of $\tan \delta \leq 0.024$ Compared to values with initial measurement A.8.1 $\geq 50\%$ of values specified in section "Insulation Resistance" of this specification



TEST CONDITIONS AND REQUIREMENTS ACCORDING AEC-Q200 REVISION C				
NO.	TEST NAME	REFERENCE	TEST CONDITIONS	PERFORMANCE REQUIREMENTS
1	Pre- and post-stress electrical test	User spec.	-	-
3	High temperature exposure (storage)	MIL-STD 202 method 108	1000 h; 110 °C; unpowered	$ \Delta C/C \leq \pm 5\%$ Increase of $\tan \delta$ 0.008 for $C \leq 1 \mu\text{F}$ at 10 kHz or 0.005 for $C > 1 \mu\text{F}$ at 1 kHz $IR \geq 50\%$ of initial requirement
4	Temperature cycling	JESD22 method JA-104	1000 cycles: -55 °C to +110 °C 10 min. dwell time each	$ \Delta C/C \leq \pm 5\%$ Increase of $\tan \delta = 0.008$ at 10 kHz $IR \geq 50\%$ of initial requirement
6	Moisture resistance	MIL-STD 202 method 106	10 cycles at 24 h/cycle unpowered	$ \Delta C/C \leq \pm 5\%$ Increase of $\tan \delta$ 0.008 for $C \leq 1 \mu\text{F}$ at 10 kHz or 0.005 for $C > 1 \mu\text{F}$ at 1 kHz $IR \geq 50\%$ of initial requirement
7	Biased humidity	MIL-STD 202 method 103	1000 h; 40 °C; 93 % RH with U_{RAC}	$ \Delta C/C \leq \pm 10\%$ Increase of $\tan \delta$ 0.008 for $C \leq 1 \mu\text{F}$ at 10 kHz or 0.005 for $C > 1 \mu\text{F}$ at 1 kHz $IR \geq 50\%$ of initial requirement
8	Operational life	MIL-STD 202 method 108	$T_{amb} = 110\text{ °C}$; 1000 h; $U_{test} = 1 \times U_{RAC}$	$ \Delta C/C \leq \pm 10\%$ Increase of $\tan \delta$ 0.008 for $C \leq 1 \mu\text{F}$ at 10 kHz or 0.005 for $C > 1 \mu\text{F}$ at 1 kHz $IR \geq 50\%$ of initial requirement
11	Terminal strength (leaded)	MIL-STD 202 method 211	Leaded device lead integrity only.	$ \Delta C/C \leq \pm 5\%$ Increase of $\tan \delta$ 0.008 for $C \leq 1 \mu\text{F}$ at 10 kHz or 0.005 for $C > 1 \mu\text{F}$ at 1 kHz $IR = \text{initial requirement}$
12	Resistance to solvents	MIL-STD 202 method 215		No visual damage Legible marking
13	Mechanical shock	MIL-STD 202 method 213	Figure a of method 213, condition C	No visual damage
14	Vibration	MIL-STD 202 method 204	5 g's for 20 min; 12 cycles, 3 orientations	No visual damage
15	Resistance to soldering heat	MIL-STD 202 method 210	260 °C; 10 s	$ \Delta C/C \leq \pm 5\%$ Increase of $\tan \delta$ 0.008 for $C \leq 1 \mu\text{F}$ at 10 kHz or 0.005 for $C > 1 \mu\text{F}$ at 1 kHz $IR = \text{initial requirement}$
18	Solderability	J-STD-002	235 °C / 5 s	Good tinning as evidence by free flowing of the solder with wetting of terminations > 95 %
19	Electrical characterization	User spec.	-	-
20	Flammability	UL 94	Electrical test not required	Maximum permitted burning time < 10 s



Disclaimer

ALL PRODUCT, PRODUCT SPECIFICATIONS AND DATA ARE SUBJECT TO CHANGE WITHOUT NOTICE TO IMPROVE RELIABILITY, FUNCTION OR DESIGN OR OTHERWISE.

Vishay Intertechnology, Inc., its affiliates, agents, and employees, and all persons acting on its or their behalf (collectively, "Vishay"), disclaim any and all liability for any errors, inaccuracies or incompleteness contained in any datasheet or in any other disclosure relating to any product.

Vishay makes no warranty, representation or guarantee regarding the suitability of the products for any particular purpose or the continuing production of any product. To the maximum extent permitted by applicable law, Vishay disclaims (i) any and all liability arising out of the application or use of any product, (ii) any and all liability, including without limitation special, consequential or incidental damages, and (iii) any and all implied warranties, including warranties of fitness for particular purpose, non-infringement and merchantability.

Statements regarding the suitability of products for certain types of applications are based on Vishay's knowledge of typical requirements that are often placed on Vishay products in generic applications. Such statements are not binding statements about the suitability of products for a particular application. It is the customer's responsibility to validate that a particular product with the properties described in the product specification is suitable for use in a particular application. Parameters provided in datasheets and / or specifications may vary in different applications and performance may vary over time. All operating parameters, including typical parameters, must be validated for each customer application by the customer's technical experts. Product specifications do not expand or otherwise modify Vishay's terms and conditions of purchase, including but not limited to the warranty expressed therein.

Hyperlinks included in this datasheet may direct users to third-party websites. These links are provided as a convenience and for informational purposes only. Inclusion of these hyperlinks does not constitute an endorsement or an approval by Vishay of any of the products, services or opinions of the corporation, organization or individual associated with the third-party website. Vishay disclaims any and all liability and bears no responsibility for the accuracy, legality or content of the third-party website or for that of subsequent links.

Vishay products are not designed for use in life-saving or life-sustaining applications or any application in which the failure of the Vishay product could result in personal injury or death unless specifically qualified in writing by Vishay. Customers using or selling Vishay products not expressly indicated for use in such applications do so at their own risk. Please contact authorized Vishay personnel to obtain written terms and conditions regarding products designed for such applications.

No license, express or implied, by estoppel or otherwise, to any intellectual property rights is granted by this document or by any conduct of Vishay. Product names and markings noted herein may be trademarks of their respective owners.