

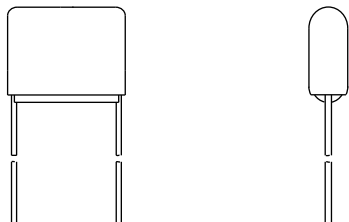

Metallized Polyester Film Capacitors MKT Radial Epoxy Partly Lacquered Type

**FEATURES**

- Partly lacquered product
- Pitch 10 mm to 22.5 mm available loose in box
- Material categorization:
for definitions of compliance please see www.vishay.com/doc?99912

RoHS
COMPLIANT**APPLICATIONS**

- Blocking, coupling and decoupling
- Bypass and energy reservoir

QUICK REFERENCE DATA

Capacitance range (E12 series)	0.01 μ F to 10 μ F
Capacitance tolerance	± 10 %; ± 5 %
Rated DC voltage	250 V; 400 V; 630 V
Rated AC voltage	63 V; 100 V; 160 V
Rated temperature	85 °C
Climatic category	55/105/56
Maximum application temperature	105 °C
Leads	Tinned wire
Reference specifications	IEC 60384-2
Dielectric	Polyester film
Electrodes	Vacuum deposited aluminum
Construction	Wound mono construction
Coating	Flame retardant epoxy material (UL-class 94 V-0)
Performance grade	Grade 1 (long life)
Marking	C-value; rated voltage; tolerance

Note

- For more detailed data and test requirements contact: dc-film@vishay.com

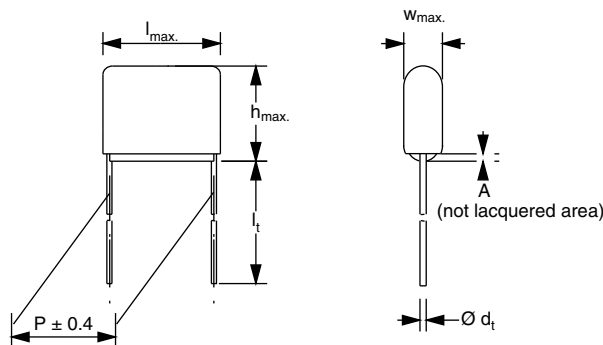
DIMENSIONS in millimeters



COMPOSITION OF CATALOG NUMBER

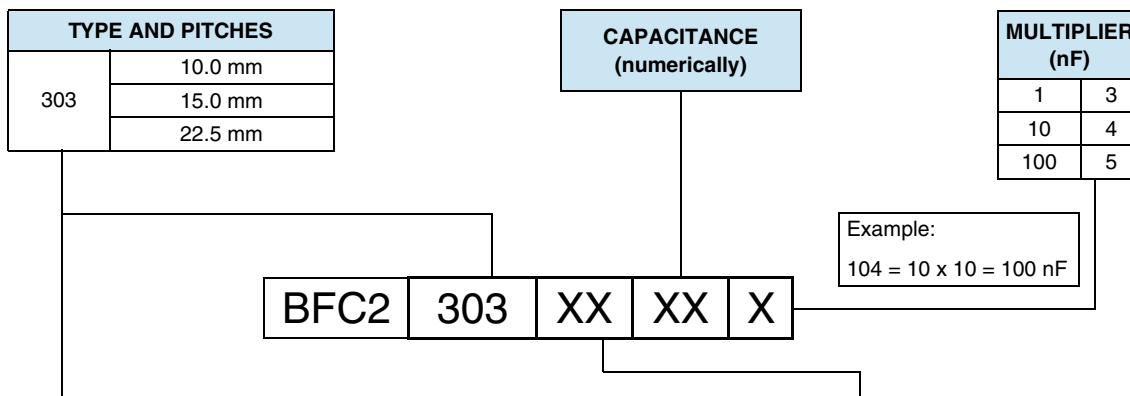

TYPE	PACKAGING	LEAD CONFIGURATION	PREFERRED			
			C-TOL.	250 V	400 V	630 V
303	Loose in box	Straight leads 3.5 mm	± 10 %	41	51	61
			± 5 %	42	52	62
			ON REQUEST			
303	Loose in box	Straight long leads	± 10 %	43	53	63
			± 5 %	44	54	64
			ON REQUEST (ALTERNATIVE DIMENSIONS)			
303	Loose in box	Straight lead 3.5 mm	± 10 %	45	55	65
			± 5 %	46	56	66
		Straight long leads	± 10 %	47	57	67
			± 5 %	48	58	68

SPECIFIC REFERENCE DATA			
DESCRIPTION	VALUE		
	at 1 kHz	at 10 kHz	at 100 kHz
Tangent of loss angle:			
$C \leq 0.47 \mu\text{F}$	$\leq 75 \times 10^{-4}$	$\leq 120 \times 10^{-4}$	$\leq 225 \times 10^{-4}$
$C > 0.47 \mu\text{F}$	$\leq 75 \times 10^{-4}$	$\leq 120 \times 10^{-4}$	-
Rated voltage pulse slope (dU/dt) _R :	at 250 V _{DC}	at 400 V _{DC}	at 630 V _{DC}
$I_{\text{max.}} = 12.5 \text{ mm}$	18 V/μs	45 V/μs	137 V/μs
$I_{\text{max.}} = 17.5 \text{ mm}$	6 V/μs	15 V/μs	44 V/μs
$I_{\text{max.}} = 26.0 \text{ mm}$	2 V/μs	6 V/μs	17 V/μs
R between leads, for $C \leq 0.33 \mu\text{F}$ at 100 V; 1 min	> 30 000 MΩ		
RC between leads, for $C > 0.33 \mu\text{F}$ at 100 V; 1 min	> 10 000 s		
R between interconnecting leads and casing; 100 V; 1 min	> 30 000 MΩ		
Withstanding (DC) voltage (cut off current 10 mA) ⁽¹⁾ ; rise time 1000 V/s	400 V; 1 min	640 V; 1 min	1008 V; 1 min
Withstanding (DC) voltage between leads and case	500 V; 1 min	800 V; 1 min	1260 V; 1 min

Note

⁽¹⁾ See "Voltage Proof Test for Metallized Film Capacitors": www.vishay.com/doc?28169



ELECTRICAL DATA AND ORDERING INFORMATION ($U_{RAC} = 63 V$)									
U_{RDC} (V)	CAP. ⁽²⁾ (μF)	DIMENSIONS $W_{max} \times H_{max} \times L_{max}$ (mm)	MASS (g)	CATALOG NUMBER 2222 303 AND PACKAGING					
				LOOSE IN BOX					
				$l_t = 3.5 \text{ mm} \pm 0.5 \text{ mm}$			LONG LEADS ⁽¹⁾		
				C-TOL. = $\pm 10 \%$	C-TOL. = $\pm 5 \%$	SPQ	C-TOL. = $\pm 10 \%$	C-TOL. = $\pm 5 \%$	SPQ
LAST 5 DIGITS OF CATALOG NUMBER	LAST 5 DIGITS OF CATALOG NUMBER	LAST 5 DIGITS OF CATALOG NUMBER	LAST 5 DIGITS OF CATALOG NUMBER						
250	PITCH = 10.0 mm \pm 0.4 mm; $d_t = 0.60 \text{ mm} \pm 0.06 \text{ mm}$; $A \leq 3.5 \text{ mm}$								
	0.10	4.7 x 9.4 x 12.5	0.5	41104	42104	2000	43104	44104	1000
	0.12	4.3 x 9.1 x 12.5	0.4	41124	42124	2000	43124	44124	1250
	0.15	4.8 x 9.5 x 12.5	0.5	41154	42154	2000	43154	44154	1000
	0.18	5.2 x 9.9 x 12.5	0.6	41184	42184	2000	43184	44184	1000
	0.22	4.5 x 9.3 x 12.5	0.5	41224	42224	2000	43224	44224	1000
	0.27	5.0 x 9.7 x 12.5	0.5	41274	42274	2000	43274	44274	1000
	0.33	4.6 x 9.3 x 12.5	0.5	41334	42334	2000	43334	44334	1000
	0.39	4.9 x 9.6 x 12.5	0.5	41394	42394	2000	43394	44394	1000
	0.47	5.4 x 10.1 x 12.5	0.6	41474	42474	2000	43474	44474	900
	0.56	5.8 x 10.5 x 12.5	0.7	41564	42564	2000	43564	44564	900
	PITCH = 15.0 mm \pm 0.4 mm; $d_t = 0.80 \text{ mm} \pm 0.08 \text{ mm}$; $A \leq 4.0 \text{ mm}$								
	<i>0.39</i>	<i>5.8 x 10.5 x 17.5</i>	0.9	45394	46394	1500	47394	48394	900
	<i>0.47</i>	<i>6.4 x 11.1 x 17.5</i>	1.1	45474	46474	1500	47474	48474	800
	0.56	5.5 x 10.2 x 17.5	0.9	45564	46564	2000	47564	48564	900
	0.68	6.0 x 10.7 x 17.5	1.0	41684	42684	1500	43684	44684	800
	0.82	5.4 x 10.2 x 17.5	0.8	41824	42824	2000	43824	44824	1000
	1.0	6.0 x 10.7 x 17.5	1.0	41105	42105	1500	43105	44105	800
	1.2	6.5 x 11.2 x 17.5	1.1	41125	42125	1500	43125	44125	750
	1.5	7.3 x 12.0 x 17.5	1.3	41155	42155	1250	43155	44155	650
	1.8	7.9 x 12.7 x 17.5	1.5	41185	42185	1250	43185	44185	600
	PITCH = 22.5 mm \pm 0.4 mm; $d_t = 0.80 \text{ mm} \pm 0.08 \text{ mm}$; $A \leq 4.0 \text{ mm}$								
	1.8	8.7 x 16.5 x 26.0	3.3	45185	46185	800	47185	48185	500
	2.2	9.7 x 17.5 x 26.0	3.8	41225	42225	700	43225	44225	500
	2.7	8.3 x 16.1 x 26.0	3.0	41275	42275	900	43275	44275	600
	3.3	9.2 x 17.1 x 26.0	3.6	41335	42335	750	43335	44335	500
	3.9	8.2 x 16.0 x 26.0	3.0	41395	42395	900	43395	44395	600
	4.7	9.0 x 16.9 x 26.0	3.4	41475	42475	750	43475	44475	500
	5.6	9.9 x 17.7 x 26.0	4.0	41565	42565	600	43565	44565	500

Notes

- (1) Length of long leads:
a) $l_t = 19.0 \text{ mm} \pm 4.0 \text{ mm}$ for pitch = 10 mm and 15.0 mm.
b) $l_t = 25.0 \text{ mm} \pm 4.0 \text{ mm}$ for pitch = 22.5 mm.
(2) Values in *Italic* indicate alternative dimensions.



ELECTRICAL DATA AND ORDERING INFORMATION ($U_{RAC} = 100\text{ V}$)									
U_{RDC} (V)	CAP. (2) (μF)	DIMENSIONS $W_{max} \times H_{max} \times L_{max}$ (mm)	MASS (g)	CATALOG NUMBER 2222 303 AND PACKAGING					
				LOOSE IN BOX					
				$l_t = 3.5\text{ mm} \pm 0.5\text{ mm}$			LONG LEADS (1)		
				C-TOL. = $\pm 10\%$	C-TOL. = $\pm 5\%$	SPQ	C-TOL. = $\pm 10\%$	C-TOL. = $\pm 5\%$	SPQ
LAST 5 DIGITS OF CATALOG NUMBER	LAST 5 DIGITS OF CATALOG NUMBER	LAST 5 DIGITS OF CATALOG NUMBER	LAST 5 DIGITS OF CATALOG NUMBER						
400	PITCH = 10.0 mm \pm 0.4 mm; $d_t = 0.60\text{ mm} \pm 0.06\text{ mm}$; $A \leq 3.5\text{ mm}$								
	0.10	4.7 x 9.4 x 12.5	0.5	51104	52104	2000	53104	54104	1000
	0.12	4.3 x 9.1 x 12.5	0.4	51124	52124	2000	53124	54124	1250
	0.15	4.8 x 9.5 x 12.5	0.5	51154	52154	2000	53154	54154	1000
	0.18	5.2 x 9.9 x 12.5	0.6	51184	52184	2000	53184	54184	1000
	0.22	5.7 x 10.4 x 12.5	0.6	51224	52224	2000	53224	54224	900
	PITCH = 15.0 mm \pm 0.4 mm; $d_t = 0.80\text{ mm} \pm 0.08\text{ mm}$; $A \leq 4.0\text{ mm}$								
	0.12	<i>5.7 x 10.4 x 17.5</i>	1.1	55124	56124	2000	57124	58124	900
	0.15	<i>5.4 x 10.1 x 17.5</i>	0.8	55154	56154	2000	57154	58154	1000
	0.18	<i>5.9 x 10.6 x 17.5</i>	1.0	55184	56184	1500	57184	58184	800
	0.22	<i>5.3 x 10.0 x 17.5</i>	0.8	55224	56224	2000	57224	58224	1000
	0.27	<i>5.8 x 10.5 x 17.5</i>	0.9	51274	52274	1500	53274	54274	900
	0.33	<i>5.4 x 10.1 x 17.5</i>	0.8	51334	52334	2000	53334	54334	1000
	0.39	<i>5.8 x 10.5 x 17.5</i>	0.9	51394	52394	1500	53394	54394	900
	0.47	<i>6.4 x 11.1 x 17.5</i>	1.1	51474	52474	1500	53474	54474	800
	0.56	<i>6.9 x 11.7 x 17.5</i>	1.2	51564	52564	1500	53564	54564	700
	0.68	<i>7.6 x 12.3 x 17.5</i>	1.4	51684	52684	1250	53684	54684	600
	0.82	<i>8.4 x 13.1 x 17.5</i>	1.7	51824	52824	1000	53824	54824	500
	PITCH = 22.5 mm \pm 0.4 mm; $d_t = 0.80\text{ mm} \pm 0.08\text{ mm}$; $A \leq 4.0\text{ mm}$								
	0.56	<i>9.9 x 17.7 x 26.0</i>	4.0	55564	56564	600	57564	58564	500
	0.68	<i>7.9 x 15.8 x 26.0</i>	2.8	55684	56684	900	57684	58684	600
	0.82	<i>8.7 x 16.6 x 26.0</i>	3.3	55824	56824	800	57824	58824	500
	1.0	<i>7.7 x 15.5 x 26.0</i>	2.7	51105	52105	900	53105	54105	600
	1.2	<i>8.4 x 16.3 x 26.0</i>	3.1	51125	52125	800	53125	54125	600
	1.5	<i>7.9 x 15.8 x 26.0</i>	2.8	51155	52155	900	53155	54155	600
	1.8	<i>8.7 x 16.6 x 26.0</i>	3.3	51185	52185	800	53185	54185	500
	2.2	<i>9.7 x 17.5 x 26.0</i>	3.8	51225	52225	700	53225	54225	500

Notes

- (1) Length of long leads:
a) $l_t = 19.0\text{ mm} \pm 4.0\text{ mm}$ for pitch = 10 mm and 15.0 mm.
b) $l_t = 25.0\text{ mm} \pm 4.0\text{ mm}$ for pitch = 22.5 mm.
(2) Values in *Italic* indicate alternative dimensions.



ELECTRICAL DATA AND ORDERING INFORMATION ($U_{RAC} = 160 V$)									
U_{RDC} (V)	CAP. ⁽²⁾ (μF)	DIMENSIONS $W_{max} \times H_{max} \times L_{max}$ (mm)	MASS (g)	CATALOG NUMBER 2222 303 AND PACKAGING					
				LOOSE IN BOX					
				$l_t = 3.5 mm \pm 0.5 mm$			LONG LEADS ⁽¹⁾		
				C-TOL. = $\pm 10\%$	C-TOL. = $\pm 5\%$	SPQ	C-TOL. = $\pm 10\%$	C-TOL. = $\pm 5\%$	SPQ
LAST 5 DIGITS OF CATALOG NUMBER	LAST 5 DIGITS OF CATALOG NUMBER	LAST 5 DIGITS OF CATALOG NUMBER	LAST 5 DIGITS OF CATALOG NUMBER						
630	PITCH = 10.0 mm \pm 0.4 mm; $d_t = 0.60 mm \pm 0.06 mm$; $A \leq 3.5 mm$								
	0.010	4.1 x 8.8 x 12.5	0.4	61103	62103	2000	63103	64103	1250
	0.012	4.5 x 9.3 x 12.5	0.5	61123	62123	2000	63123	64123	1000
	0.015	4.9 x 9.6 x 12.5	0.5	61153	62153	2000	63153	64153	1000
	0.018	4.4 x 9.1 x 12.5	0.4	61183	62183	2000	63183	64183	1250
	0.022	4.8 x 9.5 x 12.5	0.5	61223	62223	2000	63223	64223	1000
	0.027	4.2 x 8.9 x 12.5	0.4	61273	62273	2000	63273	64273	1250
	0.033	4.0 x 8.7 x 12.5	0.4	61333	62333	2000	63333	64333	1250
	0.039	4.3 x 9.0 x 12.5	0.4	61393	62393	2000	63393	64393	1250
	0.047	4.7 x 9.4 x 12.5	0.5	61473	62473	2000	63473	64473	1000
	0.056	5.1 x 9.8 x 12.5	0.5	61563	62563	2000	63563	64563	1000
	0.068	5.5 x 10.3 x 12.5	0.6	61683	62683	2000	63683	64683	900
	PITCH = 15.0 mm \pm 0.4 mm; $d_t = 0.80 mm \pm 0.08 mm$; $A \leq 4.0 mm$								
	<i>0.056</i>	<i>5.9 x 10.6 x 17.5</i>	1.0	65563	66563	1500	67563	68563	800
	<i>0.068</i>	<i>6.4 x 11.1 x 17.5</i>	1.1	65683	66683	1500	67683	68683	800
	<i>0.082</i>	<i>5.4 x 10.1 x 17.5</i>	0.8	61823	62823	2000	63823	64823	1000
	0.10	5.2 x 9.9 x 17.5	0.8	61104	62104	2000	63104	64104	1000
	0.12	5.7 x 10.4 x 17.5	0.9	61124	62124	2000	63124	64124	900
	0.15	6.3 x 11.0 x 17.5	1.1	61154	62154	1500	63154	64154	800
	0.18	6.9 x 11.6 x 17.5	1.2	61184	62184	1500	63184	64184	700
	0.22	7.6 x 12.3 x 17.5	1.4	61224	62224	1250	63224	64224	600
	0.27	8.4 x 13.1 x 17.5	1.7	61274	62274	1000	63274	64274	500
	PITCH = 22.5 mm \pm 0.4 mm; $d_t = 0.80 mm \pm 0.08 mm$; $A \leq 4.0 mm$								
	<i>0.27</i>	<i>8.9 x 16.8 x 26.0</i>	3.4	65274	66274	800	67274	68274	500
	<i>0.33</i>	<i>9.9 x 17.8 x 26.0</i>	4.0	61334	62334	600	63334	64334	500
	<i>0.39</i>	<i>8.1 x 16.0 x 26.0</i>	2.9	61394	62394	900	63394	64394	600
	<i>0.47</i>	<i>7.7 x 15.6 x 26.0</i>	2.7	61474	62474	900	63474	64474	600
	<i>0.56</i>	<i>8.4 x 16.3 x 26.0</i>	3.1	61564	62564	800	63564	64564	600
	<i>0.68</i>	<i>9.4 x 17.2 x 26.0</i>	3.7	61684	62684	700	63684	64684	500

Notes

- (1) Length of long leads:
a) $l_t = 19.0 mm \pm 4.0 mm$ for pitch = 10 mm and 15.0 mm.
b) $l_t = 25.0 mm \pm 4.0 mm$ for pitch = 22.5 mm.
(2) Values in *italic* indicate alternative dimensions.



MAXIMUM RMS VOLTAGE (SINEWAVE) AS A FUNCTION OF FREQUENCY

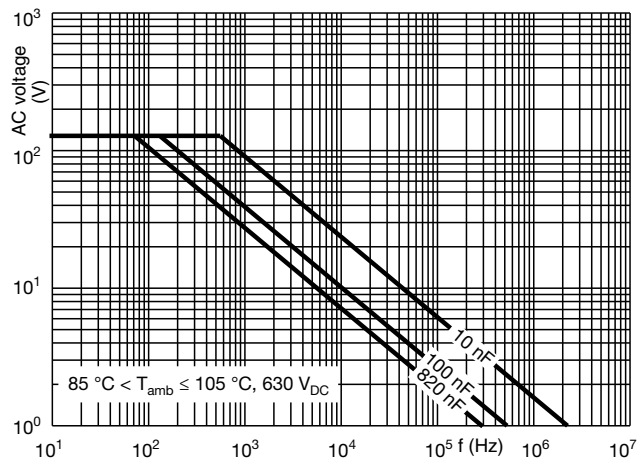
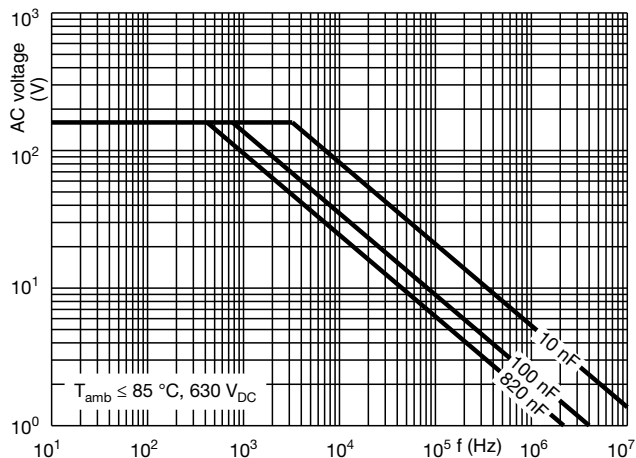
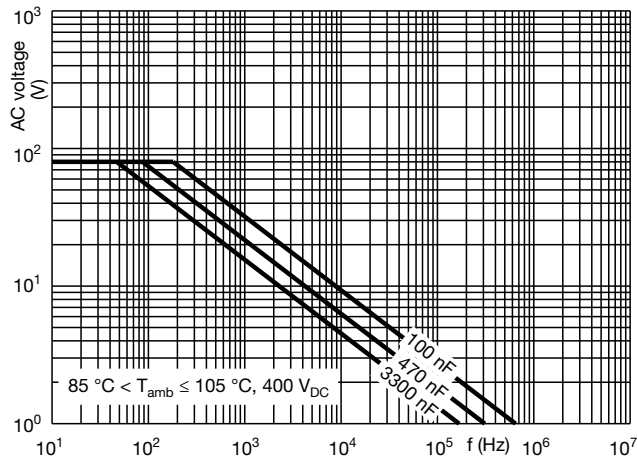
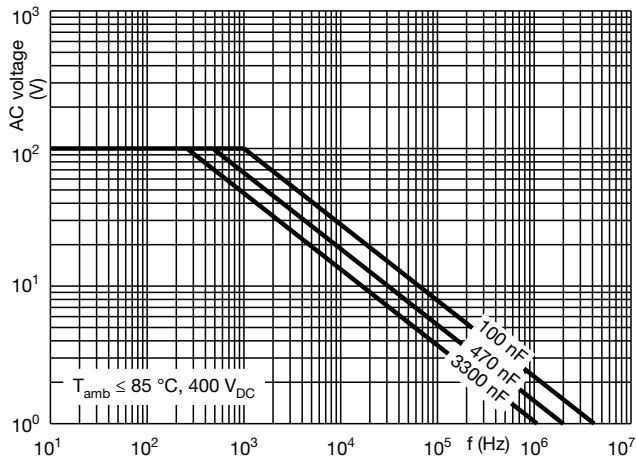
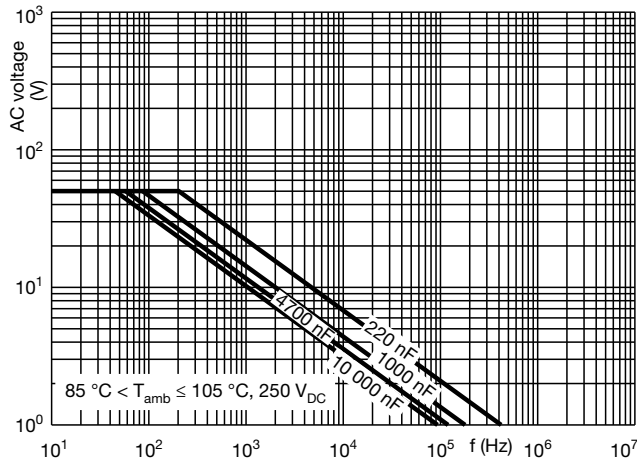
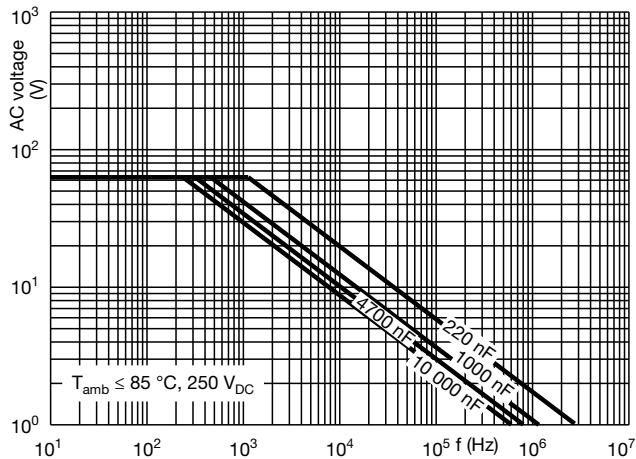



CAPACITANCE

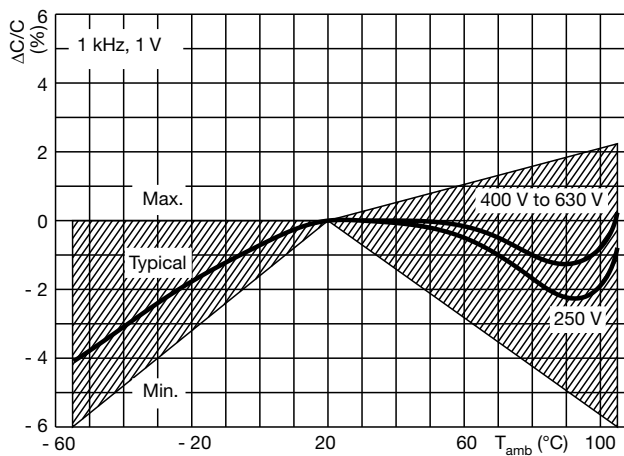
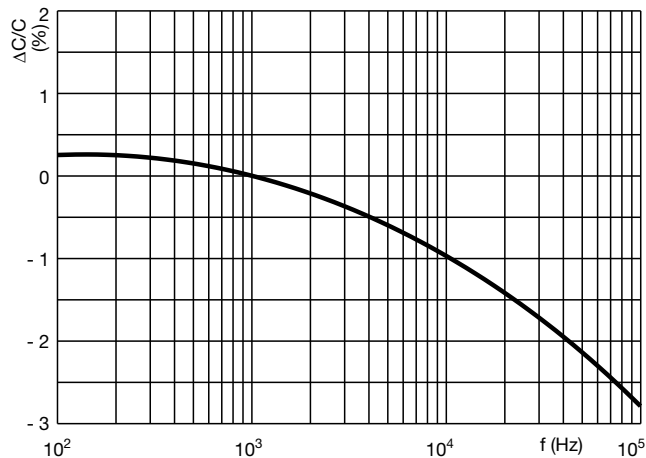

IMPEDANCE

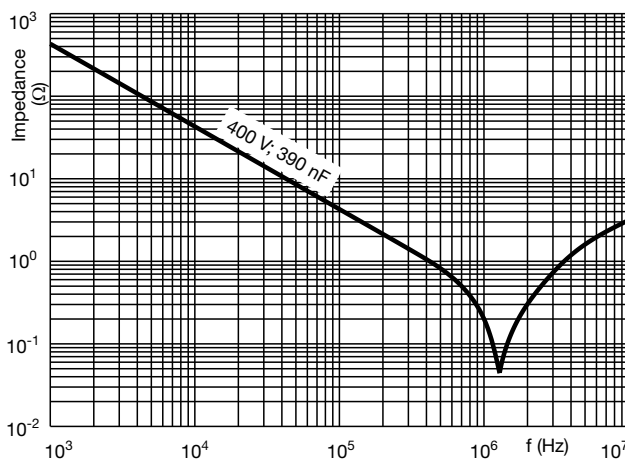



Disclaimer

ALL PRODUCT, PRODUCT SPECIFICATIONS AND DATA ARE SUBJECT TO CHANGE WITHOUT NOTICE TO IMPROVE RELIABILITY, FUNCTION OR DESIGN OR OTHERWISE.

Vishay Intertechnology, Inc., its affiliates, agents, and employees, and all persons acting on its or their behalf (collectively, "Vishay"), disclaim any and all liability for any errors, inaccuracies or incompleteness contained in any datasheet or in any other disclosure relating to any product.

Vishay makes no warranty, representation or guarantee regarding the suitability of the products for any particular purpose or the continuing production of any product. To the maximum extent permitted by applicable law, Vishay disclaims (i) any and all liability arising out of the application or use of any product, (ii) any and all liability, including without limitation special, consequential or incidental damages, and (iii) any and all implied warranties, including warranties of fitness for particular purpose, non-infringement and merchantability.

Statements regarding the suitability of products for certain types of applications are based on Vishay's knowledge of typical requirements that are often placed on Vishay products in generic applications. Such statements are not binding statements about the suitability of products for a particular application. It is the customer's responsibility to validate that a particular product with the properties described in the product specification is suitable for use in a particular application. Parameters provided in datasheets and / or specifications may vary in different applications and performance may vary over time. All operating parameters, including typical parameters, must be validated for each customer application by the customer's technical experts. Product specifications do not expand or otherwise modify Vishay's terms and conditions of purchase, including but not limited to the warranty expressed therein.

Hyperlinks included in this datasheet may direct users to third-party websites. These links are provided as a convenience and for informational purposes only. Inclusion of these hyperlinks does not constitute an endorsement or an approval by Vishay of any of the products, services or opinions of the corporation, organization or individual associated with the third-party website. Vishay disclaims any and all liability and bears no responsibility for the accuracy, legality or content of the third-party website or for that of subsequent links.

Vishay products are not designed for use in life-saving or life-sustaining applications or any application in which the failure of the Vishay product could result in personal injury or death unless specifically qualified in writing by Vishay. Customers using or selling Vishay products not expressly indicated for use in such applications do so at their own risk. Please contact authorized Vishay personnel to obtain written terms and conditions regarding products designed for such applications.

No license, express or implied, by estoppel or otherwise, to any intellectual property rights is granted by this document or by any conduct of Vishay. Product names and markings noted herein may be trademarks of their respective owners.