

DC Film Capacitors MKT Radial Potted Type

FEATURES

- 10 mm to 27.5 mm lead pitch
- Supplied loose in box taped on ammpack or reel
- Material categorization:
for definitions of compliance please see www.vishay.com/doc?99912

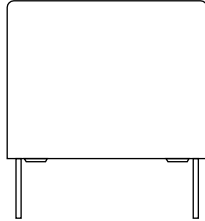

RoHS
COMPLIANT
HALOGEN
FREE

APPLICATIONS

Blocking, coupling, and decoupling, bypass and energy reservoir, industrial, consumer, lighting.

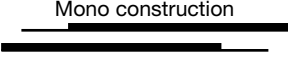
QUICK REFERENCE DATA	
Capacitance range (E12 series)	0.01 μ F to 10 μ F
Capacitance tolerance	$\pm 10\%$, $\pm 5\%$
Climatic testing class according to IEC 60068-1	55/105/56
Maximum application temperature	105 °C
Reference standards	IEC 60384-2
Dielectric	Polyester film
Electrodes	Metallized
Construction	Mono construction 
Encapsulation	Flame retardant plastic case and epoxy resin UL-class 94 V-0
Leads	Tinned wire
Marking	C-value; tolerance; rated voltage; manufacturer's symbol; year and week of manufacture; manufacturer's type designation
Rated (DC) voltage	250 V, 400 V, 630 V
Rated (AC) voltage	63 V, 100 V, 160 V
Rated temperature	85 °C
Performance grade	Grade 1 (long life)

Note

- For more detailed data and test requirements, contact dc-film@vishay.com

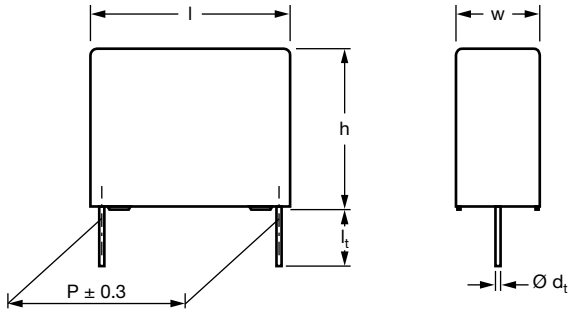
DIMENSIONS



COMPOSITION OF CATALOG NUMBER

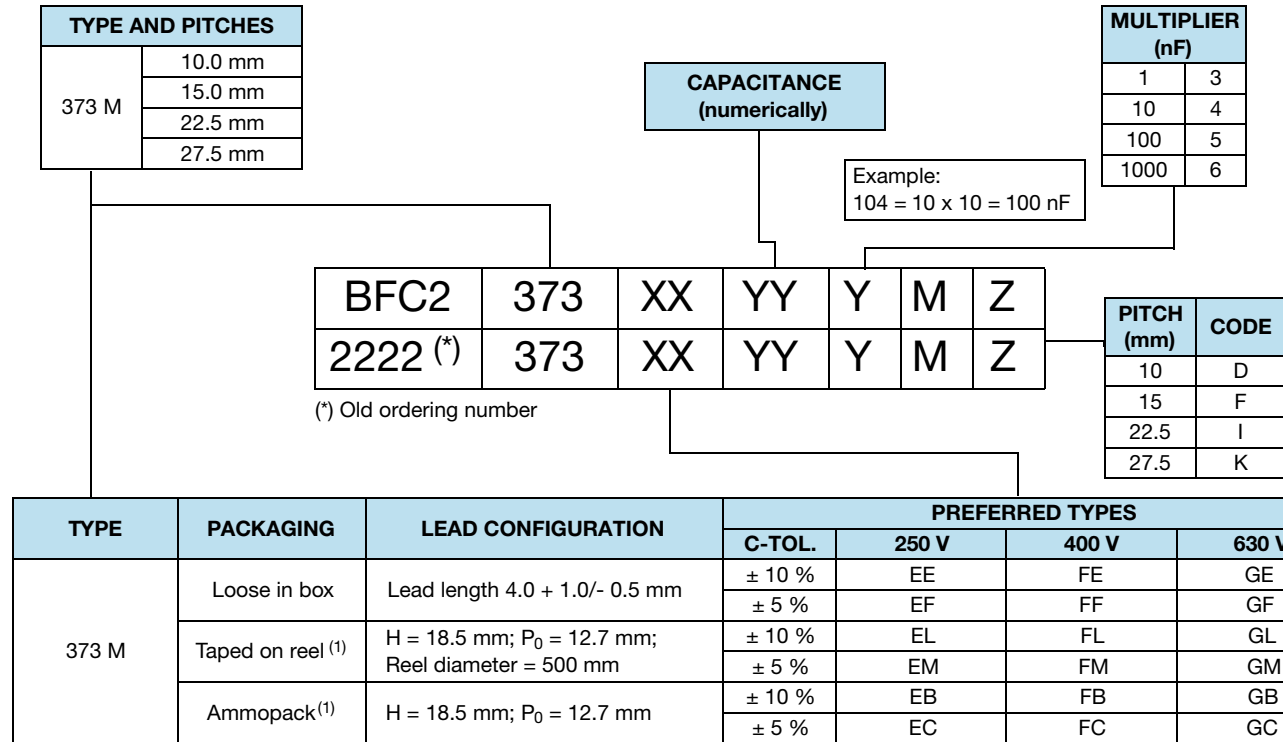

Note

⁽¹⁾ For detailed tape specifications refer to packaging information: www.vishay.com/doc?28139

SPECIFIC REFERENCE DATA			
DESCRIPTION	VALUE		
	at 1 kHz	at 10 kHz	at 100 kHz
Tangent of loss angle:			
C ≤ 0.1 μF	≤ 75 x 10 ⁻⁴	≤ 130 x 10 ⁻⁴	≤ 250 x 10 ⁻⁴
0.1 μF < C ≤ 0.47 μF	≤ 75 x 10 ⁻⁴	≤ 130 x 10 ⁻⁴	≤ 300 x 10 ⁻⁴
0.47 μF < C ≤ 1.0 μF	≤ 75 x 10 ⁻⁴	≤ 130 x 10 ⁻⁴	-
1.0 μF < C ≤ 10 μF	≤ 75 x 10 ⁻⁴	≤ 150 x 10 ⁻⁴	-
C > 10 μF	≤ 75 x 10 ⁻⁴	-	-
Rated voltage pulse slope (dU/dt) _R at	250 V _{DC}	400 V _{DC}	630 V _{DC}
L _{max.} = 12.5 mm	20 V/μs	45 V/μs	137 V/μs
L _{max.} = 17.5 mm	11 V/μs	20 V/μs	44 V/μs
L _{max.} = 26.0 mm	7 V/μs	10 V/μs	17 V/μs
L _{max.} = 30.0 mm	5 V/μs	8 V/μs	12 V/μs
R between leads, for C ≤ 0.33 μF at 100 V; 1 min	> 30 000 MΩ	> 30 000 MΩ	-
R between leads, for C ≤ 0.33 μF at 500 V; 1 min	-	-	> 30 000 MΩ
RC between leads, for C > 0.33 μF at 100 V; 1 min	> 10 000 s	> 10 000 s	-
RC between leads, for C > 0.33 μF at 500 V; 1 min	-	-	> 10 000 s
R between interconnecting leads and casing, 100 V; 1 min	> 30 000 MΩ		
Withstanding (DC) voltage (cut off current 10 mA) ⁽¹⁾ ; rise time ≤ 1000 V/s:	250 V _{DC}	400 V _{DC}	630 V _{DC}
	400 V; 1 min	640 V; 1 min	1008 V; 1 min
Withstanding (DC) voltage between leads and case for	250 V _{DC}	400 V _{DC}	630 V _{DC}
	500 V; 1 min	800 V; 1 min	1260 V; 1 min
Maximum application temperature	105 °C		

Note

⁽¹⁾ See "Voltage Proof Test for Metallized Film Capacitors": www.vishay.com/doc?28169



ELECTRICAL DATA AND ORDERING INFORMATION													
U_{RDC} (V)	CAP. (μ F)	DIMENSIONS w x h x l (mm)	MASS (g) ⁽³⁾	CATALOG NUMBER BFC2 373 XXYYMZ AND PACKAGING								C- VALUE ..YYY	PITCH mm CODE MZ
				LOOSE IN BOX		REEL (500 mm) ⁽¹⁾⁽²⁾		AMMOPACK ⁽²⁾		C-TOL. = $\pm 10\%$	C-TOL. = $\pm 5\%$		
				$l_t = 4.0\text{ mm} + 1.0\text{ mm}/$ $- 0.5\text{ mm}$		H = 18.5 mm; P ₀ = 12.7 mm		H = 18.5 mm; P ₀ = 12.7 mm					
				XX (SPQ)	XX (SPQ)	XX (SPQ)	XX (SPQ)	XX (SPQ)	XX (SPQ)				
PITCH = 10.0 mm \pm 0.40 mm; $d_t = 0.60\text{ mm} \pm 0.06\text{ mm}$ ($U_{RAC} = 63\text{ V}$)													
250	0.10	4.0 x 10.0 x 12.5	0.65	EE... (1000)	EF... (1000)	EL... (1400)	EM... (1400)	EB... (750)	EC... (750)	104	MD		
	0.12									124	MD		
	0.15									154	MD		
	0.18									184	MD		
	0.22									224	MD		
	0.27									274	MD		
	0.33	5.0 x 11.0 x 12.5	0.87	EE... (1000)	EF... (1000)	EL... (1100)	EM... (1100)	EB... (600)	EC... (600)	334	MD		
	0.39									394	MD		
	0.47	6.0 x 12.0 x 12.5	1.15	EE... (750)	EF... (750)	EL... (900)	EM... (900)	EB... (500)	EC... (500)	474	MD		
	0.56									564	MD		
	PITCH = 15.0 mm \pm 0.40 mm; $d_t = 0.60\text{ mm} \pm 0.06\text{ mm}$ ($U_{RAC} = 63\text{ V}$)												
	0.56	5.0 x 11.0 x 17.5	1.1	EE... (1000)	EF... (1000)	EL... (1100)	EM... (1100)	Not available	564	MF			
	0.68	6.0 x 12.0 x 17.5	1.5	EE... (1000)	EF... (1000)	EL... (900)	EM... (900)		684	MF			
	0.82								824	MF			
	PITCH = 15.0 mm \pm 0.40 mm; $d_t = 0.80\text{ mm} \pm 0.08\text{ mm}$ ($U_{RAC} = 63\text{ V}$)												
	1.0	7.0 x 13.5 x 17.5	2.0	EE... (1000)	EF... (1000)	EL... (800)	EM... (800)	Not available	105	MF			
	1.2	8.5 x 15.0 x 17.5	2.7	EE... (1000)	EF... (1000)	EL... (650)	EM... (650)		125	MF			
	1.5								155	MF			
	1.8	10.0 x 16.5 x 17.5	3.5	EE... (500)	EF... (500)	EL... (600)	EM... (600)		185	MF			
	PITCH = 22.5 mm \pm 0.40 mm; $d_t = 0.80\text{ mm} \pm 0.08\text{ mm}$ ($U_{RAC} = 63\text{ V}$)												
	2.2	8.5 x 18.0 x 26.0	4.5	EE... (200)	EF... (200)	EL... (450)	EM... (450)	Not available	225	MI			
	2.7								275	MI			
	3.3								335	MI			
	3.9	10.0 x 19.5 x 26.0	5.7	EE... (200)	EF... (200)	EL... (350)	EM... (350)		395	MI			
4.7	475								MI				
5.6	565								MI				
6.8	12.0 x 22.0 x 26.0	7.8	EE... (150)	EF... (150)	EL... (300)	EM... (300)	685	MI					
8.2							825	MI					
PITCH = 27.5 mm \pm 0.40 mm; $d_t = 0.80\text{ mm} \pm 0.08\text{ mm}$ ($U_{RAC} = 63\text{ V}$)													
6.8	13.0 x 23.0 x 31.0	10.4	EE... (100)	EF... (100)	Not available	Not available	685	MK					
8.2	15.0 x 25.0 x 31.5	12.8	EE... (100)	EF... (100)			825	MK					
10.0							106	MK					
15.0	18.0 x 28.0 x 31.5	18.4	EE... (100)	EF... (100)			156	MK					



ELECTRICAL DATA AND ORDERING INFORMATION

U _{RDC} (V)	CAP. (μF)	DIMENSIONS w x h x l (mm)	MASS (g) ⁽³⁾	CATALOG NUMBER BFC2 373 XXYYMZ AND PACKAGING								C- VALUE ..YYY	PITCH mm CODE MZ
				LOOSE IN BOX		REEL (500 mm) ⁽¹⁾⁽²⁾		AMMOPACK ⁽²⁾					
				l _t = 4.0 mm + 1.0 mm/ - 0.5 mm		H = 18.5 mm; P ₀ = 12.7 mm		H = 18.5 mm; P ₀ = 12.7 mm					
				C-TOL. = ± 10 %	C-TOL. = ± 5 %	C-TOL. = ± 10 %	C-TOL. = ± 5 %	C-TOL. = ± 10 %	C-TOL. = ± 5 %				
		XX (SPQ)	XX (SPQ)	XX (SPQ)	XX (SPQ)	XX (SPQ)	XX (SPQ)						
PITCH = 10.0 mm ± 0.40 mm; d_t = 0.60 mm ± 0.06 mm (U_{RAC} = 100 V)													
400	0.082	4.0 x 10.0 x 12.5	0.65							823	MD		
	0.10			FE...	FF...	FL...	FM...	FB...	FC...	104	MD		
	0.12			(1000)	(1000)	(1400)	(1400)	(750)	(750)	124	MD		
	0.15									154	MD		
	0.18	5.0 x 11.0 x 12.5	0.87							184	MD		
	0.22			FE...	FF...	FL...	FM...	FB...	FC...	224	MD		
	0.27			(1000)	(1000)	(1100)	(1100)	(600)	(600)	274	MD		
	0.33	6.0 x 12.0 x 12.5	1.15							334	MD		
					FE...	FF...	FL...	FM...	FB...	FC...			
					(750)	(750)	(900)	(900)	(500)	(500)			
	PITCH = 15.0 mm ± 0.40 mm; d_t = 0.60 mm ± 0.06 mm (U_{RAC} = 100 V)												
		0.27	5.0 x 11.0 x 17.5	1.1							274	MF	
	0.33	FE...			FF...	FL...	FM...			334	MF		
	0.39	(1000)			(1000)	(1100)	(1100)	Not available		394	MF		
	0.47	6.0 x 12.0 x 17.5	1.5							474	MF		
	0.56			FE...	FF...	FL...	FM...			564	MF		
				(1000)	(1000)	(900)	(900)						
PITCH = 15.0 mm ± 0.40 mm; d_t = 0.80 mm ± 0.08 mm (U_{RAC} = 100 V)													
	0.68	7.0 x 13.5 x 17.5	2.0							684	MF		
	0.82	8.5 x 15.0 x 17.5	2.7							824	MF		
	1.0			FE...	FF...	FL...	FM...	Not available		105	MF		
	1.2			(1000)	(1000)	(650)	(650)			125	MF		
	1.5	10.0 x 16.5 x 17.5	3.5							155	MF		
				FE...	FF...	FL...	FM...						
				(500)	(500)	(600)	(600)						
PITCH = 22.5 mm ± 0.40 mm; d_t = 0.80 mm ± 0.08 mm (U_{RAC} = 100 V)													
	1.0	7.0 x 16.5 x 26.0	3.3							105	MI		
	1.2			FE...	FF...	FL...	FM...	Not available		125	MI		
	1.5			(200)	(200)	(450)	(450)			155	MI		
	1.8	8.5 x 18.0 x 26.0	4.5							185	MI		
	2.2			FE...	FF...	FL...	FM...			225	MI		
				(200)	(200)	(450)	(450)						
	2.7	10.0 x 19.5 x 26.0	5.7							275	MI		
	3.3			FE...	FF...	FL...	FM...			335	MI		
				(200)	(200)	(350)	(350)						
	3.9	12.0 x 22.0 x 26.0	7.8							395	MI		
				FE...	FF...	FL...	FM...						
				(150)	(150)	(300)	(300)						
PITCH = 27.5 mm ± 0.40 mm; d_t = 0.80 mm ± 0.08 mm (U_{RAC} = 100 V)													
	2.7	9.0 x 19.0 x 31.5	5.5							275	MK		
	3.3	11.0 x 21.0 x 31.0	7.8							335	MK		
	3.9			FE...	FF...	Not available		Not available		395	MK		
				(100)	(100)								
				(100)	(100)								
				(100)	(100)								



ELECTRICAL DATA AND ORDERING INFORMATION													
U _{RDC} (V)	CAP. (μF)	DIMENSIONS w x h x l (mm)	MASS (g) ⁽³⁾	CATALOG NUMBER BFC2 373 XXYYMZ AND PACKAGING								C- VALUE ..YYY	PITCH mm CODE MZ
				LOOSE IN BOX		REEL (500 mm) ⁽¹⁾⁽²⁾		AMMOPACK ⁽²⁾					
				l _t = 4.0 mm + 1.0 mm/ - 0.5 mm		H = 18.5 mm; P ₀ = 12.7 mm		H = 18.5 mm; P ₀ = 12.7 mm					
				C-TOL. = ± 10 %	C-TOL. = ± 5 %	C-TOL. = ± 10 %	C-TOL. = ± 5 %	C-TOL. = ± 10 %	C-TOL. = ± 5 %				
XX (SPQ)		XX (SPQ)		XX (SPQ)		XX (SPQ)		XX (SPQ)					
PITCH = 10.0 mm ± 0.40 mm; d_t = 0.60 mm ± 0.06 mm (U_{RAC} = 160 V)													
0.010		4.0 x 10.0 x 12.5	0.65	GE... (1000)	GF... (1000)	GL... (1400)	GM... (1400)	GB... (750)	GC... (750)	103	MD		
0.012										123	MD		
0.015										153	MD		
0.018										183	MD		
0.022										223	MD		
0.027										273	MD		
0.033										333	MD		
0.039										393	MD		
0.047										473	MD		
0.056		563	MD										
0.068		5.0 x 11.0 x 12.5	0.87	GE... (1000)	GF... (1000)	GL... (1100)	GM... (1100)	GB... (600)	GC... (600)	683	MD		
0.082										823	MD		
0.100		6.0 x 12.0 x 12.5	1.15	GE... (750)	GF... (750)	GL... (900)	GM... (900)	GB... (500)	GC... (500)	104	MD		
PITCH = 15.0 mm ± 0.40 mm; d_t = 0.60 mm ± 0.06 mm (U_{RAC} = 160 V)													
0.082		5.0 x 11.0 x 17.5	1.1	GE... (1000)	GF... (1000)	GL... (1100)	GM... (1100)	Not available		823	MF		
0.100										104	MF		
0.120										124	MF		
0.150		6.0 x 12.0 x 17.5	1.5	GE... (1000)	GF... (1000)	GL... (900)	GM... (900)	Not available		154	MF		
0.180										184	MF		
PITCH = 15.0 mm ± 0.40 mm; d_t = 0.80 mm ± 0.08 mm (U_{RAC} = 160 V)													
0.22		7.0 x 13.5 x 17.5	2.0	GE... (1000)	GF... (1000)	GL... (800)	GM... (800)	Not available		224	MF		
0.27		8.5 x 15.0 x 17.5	2.7	GE... (1000)	GF... (1000)	GL... (650)	GM... (650)			274	MF		
0.33										334	MF		
0.39										394	MF		
0.47		10.0 x 16.5 x 17.5	3.5	GE... (500)	GF... (500)	GL... (600)	GM... (600)			474	MF		
PITCH = 22.5 mm ± 0.40 mm; d_t = 0.80 mm ± 0.08 mm (U_{RAC} = 160 V)													
0.33		8.5 x 18.0 x 26.0	4.5	GE... (200)	GF... (200)	GL... (450)	GM... (450)	Not available		334	MI		
0.39										394	MI		
0.47										474	MI		
0.56										564	MI		
0.68										684	MI		
0.82										824	MI		
1.00		10.0 x 19.5 x 26.0	5.7	GE... (200)	GF... (200)	GL... (350)	GM... (350)	105	MI				
1.20		12.0 x 22.0 x 26.0	7.8	GE... (150)	GF... (150)	GL... (300)	GM... (300)	125	MI				
PITCH = 27.5 mm ± 0.40 mm; d_t = 0.80 mm ± 0.08 mm (U_{RAC} = 160 V)													
0.82		9.0 x 19.0 x 31.5	5.5	GE... (100)	GF... (100)	Not available		Not available		824	MK		
1.00		11.0 x 21.0 x 31.0	7.8	GE... (100)	GF... (100)					105	MK		
1.20										125	MK		

Notes

- SPQ = Standard Packing Quantity
- (1) H = in-tape height; P₀ = sprocket hole distance; for detailed specifications refer to Packaging Information.
- (2) Reel diameter = 356 mm is available on request
- (3) Weight for short lead product only

MOUNTING

Normal Use

The capacitors are designed for mounting on printed-circuit boards. The capacitors packed in bandoliers are designed for mounting in printed-circuit boards by means of automatic insertion machines.

For detailed tape specifications refer to type detail information: www.vishay.com/doc?28139

Specific Method of Mounting to Withstand Vibration and Shock

In order to withstand vibration and shock tests, it must be ensured that the underside of this product is in good contact with the printed-circuit board:

- For pitches ≤ 15 mm capacitors shall be mechanically fixed by the leads
- For larger pitches the capacitors shall be mounted in the same way and the body clamped

Ratings and Characteristics Reference Conditions

Unless otherwise specified, all electrical values apply to an ambient temperature of $23\text{ }^{\circ}\text{C} \pm 1\text{ }^{\circ}\text{C}$, an atmospheric pressure of 86 kPa to 106 kPa and a relative humidity of $50\% \pm 2\%$.

For reference testing, a conditioning period shall be applied over $96\text{ h} \pm 4\text{ h}$ by heating the products in a circulating air oven at the rated temperature and a relative humidity not exceeding 20 %.

SPACE REQUIREMENTS FOR PRINTED-CIRCUIT BOARD APPLICATIONS AND DIMENSION TOLERANCES

The maximum space for length ($l_{\max.}$), width ($w_{\max.}$), and height ($h_{\max.}$) of film capacitors to take in account on the printed-circuit board is shown in the drawings:

- For products with pitch ≤ 15 mm, $\Delta w = \Delta l = 0.3$ mm and $\Delta h = 0.1$ mm
- For products with $15\text{ mm} < \text{pitch} \leq 27.5$ mm, $\Delta w = \Delta l = 0.5$ mm and $\Delta h = 0.1$ mm

Eccentricity defined as in drawing. The maximum eccentricity is smaller than or equal to the lead diameter of the product concerned.

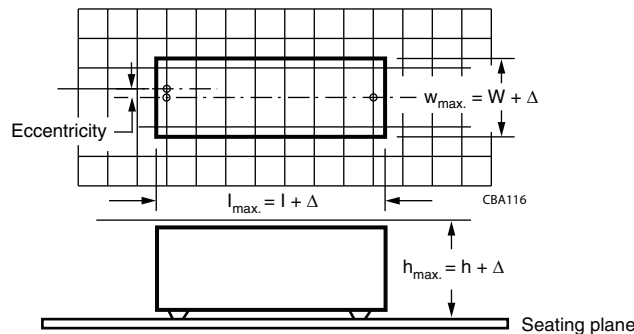

For the minimum product dimensions for length ($l_{\min.}$), width ($w_{\min.}$), and height ($h_{\min.}$) following tolerances of the components are valid:

$l_{\min.} = l - \Delta l$, $w_{\min.} = w - \Delta w$, and $h_{\min.} = h - \Delta h$ following

- For products with pitch ≤ 10 mm, $\Delta l = 0.3$ mm and $\Delta w = \Delta h = 0.3$ mm
- For products with pitch = 15 mm, $\Delta l = 0.5$ mm and $\Delta w = \Delta h = 0.5$ mm
- For products with $15\text{ mm} < \text{pitch} \leq 27.5$ mm, $\Delta l = 1.0$ mm and $\Delta w = \Delta h = 0.5$ mm

SOLDERING CONDITIONS

For general soldering conditions and wave soldering profile, we refer to the application note:

“Soldering Guidelines for Film Capacitors”: www.vishay.com/doc?28171

Storage Temperature

$T_{\text{stg}} = -25\text{ }^{\circ}\text{C}$ to $+35\text{ }^{\circ}\text{C}$ with RH maximum 75 % without condensation



CHARACTERISTICS

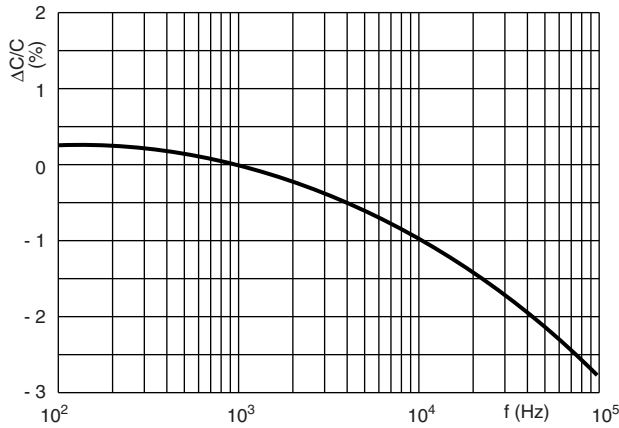

Capacitance as a function of frequency

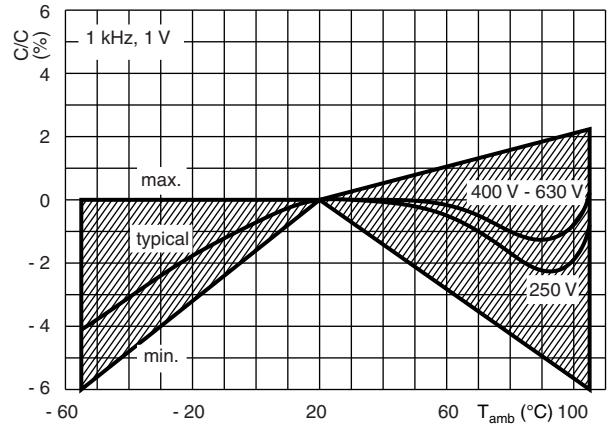

Capacitance as a function of ambient temperature

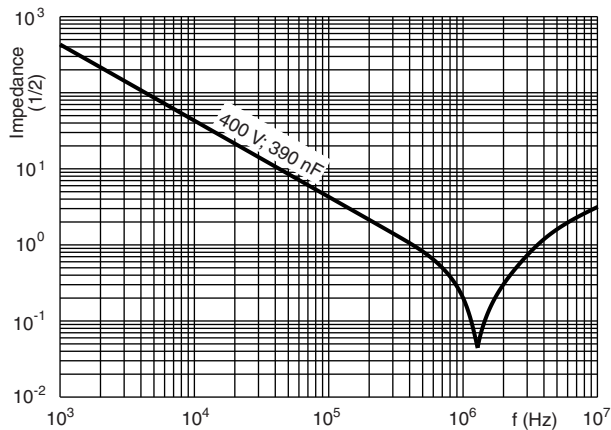

Impedance as a function of frequency

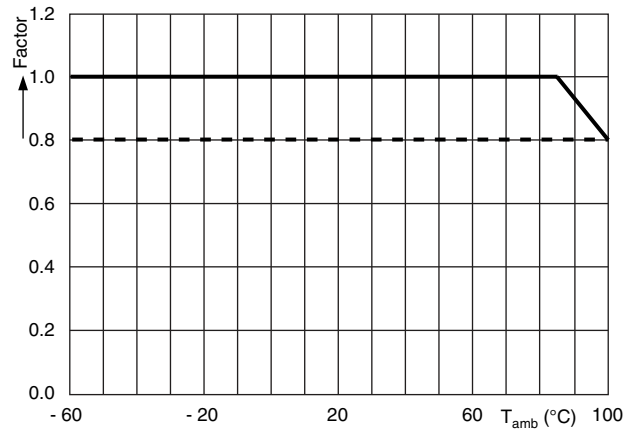

Max. DC and AC voltage as a function of temperature

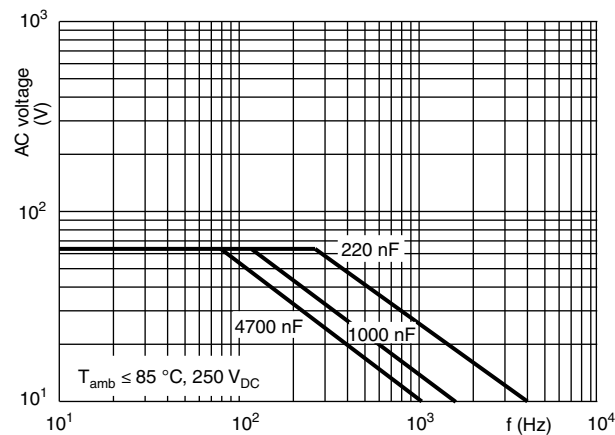

Max. RMS voltage and AC current (sinewave)

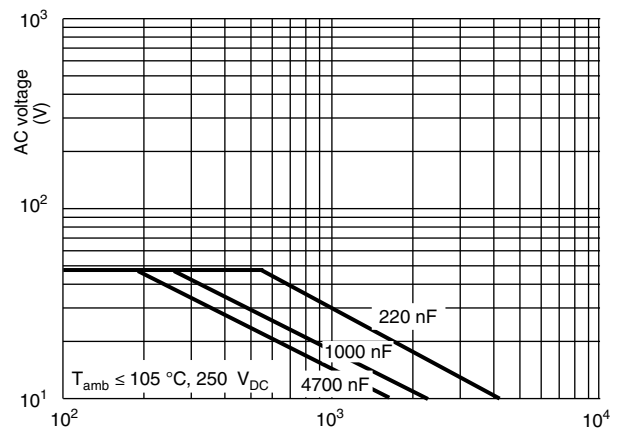

Max. RMS voltage and AC current (sinewave)

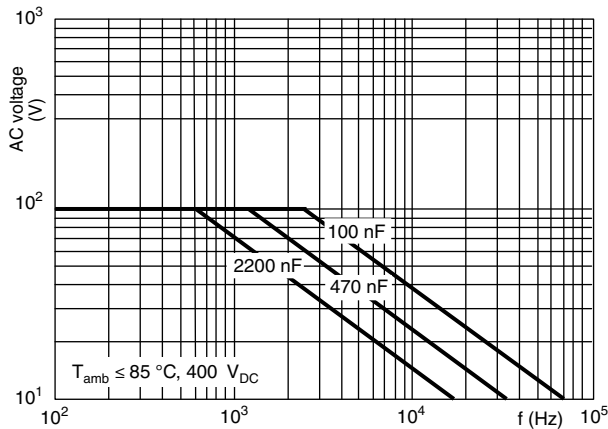

Max. RMS voltage and AC current (sinewave)

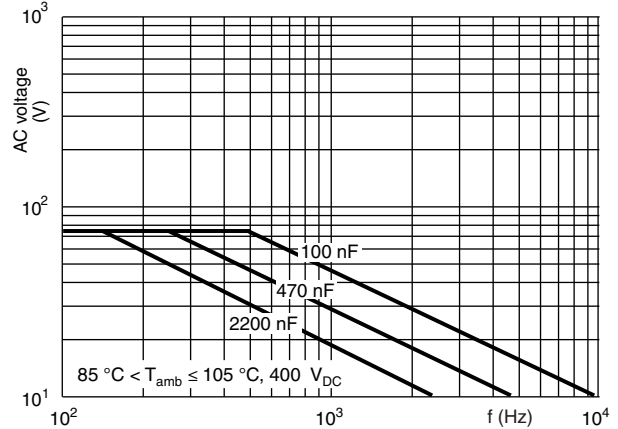

Max. RMS voltage and AC current (sinewave)

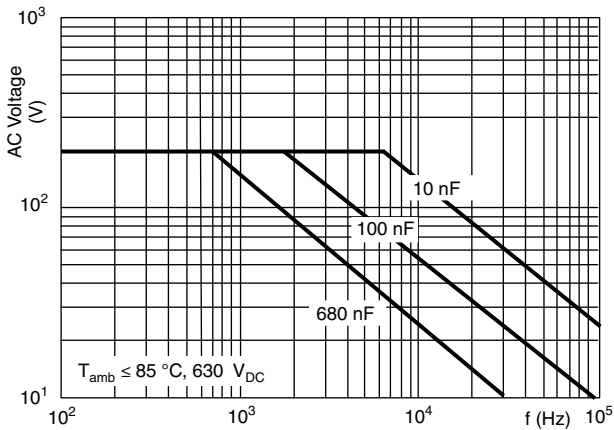

Max. RMS voltage and AC current (sinewave)

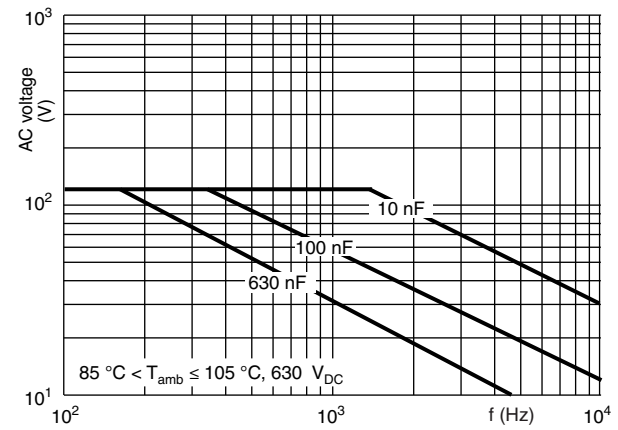

Max. RMS voltage and AC current (sinewave)

Maximum RMS Current (Sinewave) as a Function of Frequency

The maximum RMS current is defined by $I_{AC} = \omega \times C \times U_{AC}$.

U_{AC} is the maximum AC voltage depending on the ambient temperature in the curves “Max. RMS voltage and AC current as a function of frequency”.

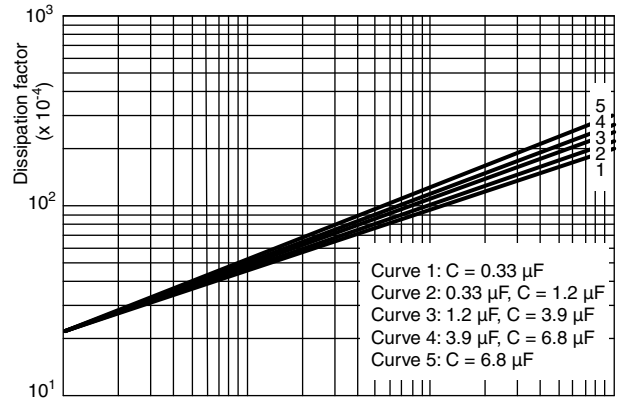

Tangent of loss angle as a function of frequency (typical curve)

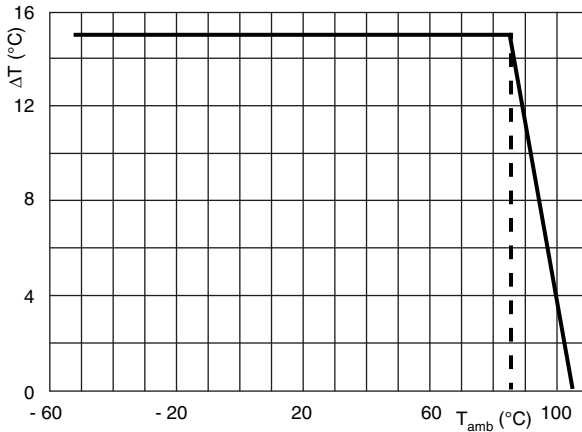

Maximum allowed component temperature rise (ΔT) as a function of the ambient temperature (T_{amb})

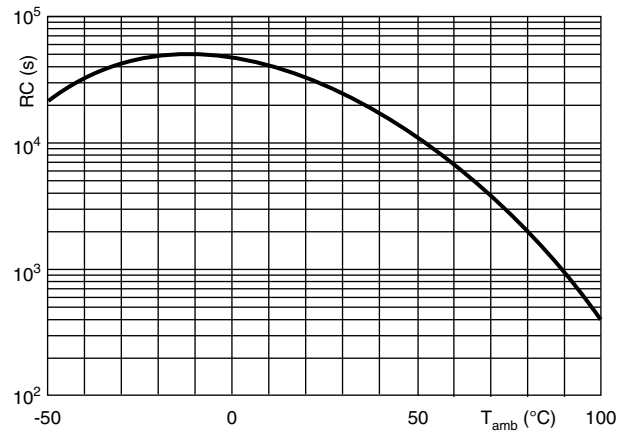

Insulation resistance as a function of the ambient temperature (typical curve)

HEAT CONDUCTIVITY (G) AS A FUNCTION OF (ORIGINAL) PITCH AND CAPACITOR BODY THICKNESS IN mW/°C

$W_{max.}$ (mm)	HEAT CONDUCTIVITY (mW/°C)			
	PITCH 10 mm	PITCH 15 mm	PITCH 22.5 mm	PITCH 27.5 mm
4.0	6.0	-	-	-
4.5	-	-	-	-
5.0	7.5	10	-	-
6.0	9.0	11	19	-
7.0	-	12	21	-
8.5	-	16	25	-
10.0	-	18	28	-
11.0	-	-	-	36
12.0	-	-	34	-
13.0	-	-	-	42
15.0	-	-	-	48
18.0	-	-	-	57

POWER DISSIPATION AND MAXIMUM COMPONENT TEMPERATURE RISE

The power dissipation must be limited in order not to exceed the maximum allowed component temperature rise as a function of the free ambient temperature.

The power dissipation can be calculated according type detail specification “HQN-384-01/101: Technical Information Film Capacitors”, www.vishay.com/doc?28147.

The component temperature rise (ΔT) can be measured (see section “Measuring the component temperature” for more details) or calculated by $\Delta T = P/G$:

- ΔT = component temperature rise ($^{\circ}\text{C}$)
- P = power dissipation of the component (mW)
- G = heat conductivity of the component (mW/ $^{\circ}\text{C}$)

MEASURING THE COMPONENT TEMPERATURE

A thermocouple must be attached to the capacitor body as in:

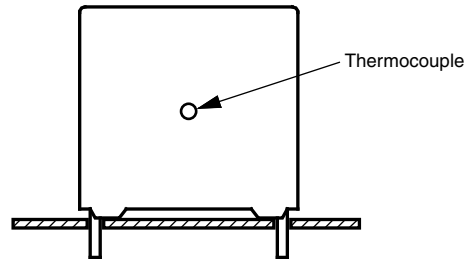

The temperature is measured in unloaded (T_{amb}) and maximum loaded condition (T_C).

The temperature rise is given by $\Delta T = T_C - T_{\text{amb}}$.

To avoid radiation or convection, the capacitor should be tested in a wind-free box.

APPLICATION NOTE AND LIMITING CONDITIONS

These capacitors are not suitable for mains applications as across-the-line capacitors.

For capacitors connected in parallel, normally the proof voltage and possibly the rated voltage must be reduced. For information depending of the capacitance value and the number of parallel connections contact: dc-film@vishay.com

To select the capacitor for a certain application, the following conditions must be checked:

1. The peak voltage (U_P) shall not be greater than the rated DC voltage (U_{RDC})
2. The peak-to-peak voltage ($U_{\text{P-P}}$) shall not be greater than $2\sqrt{2} \times U_{\text{RAC}}$ to avoid the ionization inception level
3. The voltage peak slope (dU/dt) shall not exceed the rated voltage pulse slope in an RC-circuit at rated voltage and without ringing. If the pulse voltage is lower than the rated DC voltage, the rated voltage pulse slope may be multiplied by U_{RDC} and divided by the applied voltage.

For all other pulses following equation must be fulfilled:

$$2 \times \int_0^T \left(\frac{dU}{dt} \right)^2 \times dt < U_{\text{RDC}} \times \left(\frac{dU}{dt} \right)_{\text{rated}}$$

T is the pulse duration.

The rated voltage pulse slope is valid for ambient temperatures up to 85°C . For higher temperatures a derating factor of 3 % per K shall be applied.

4. The maximum component surface temperature rise must be lower than the limits (see figure Max. Allowed Component Temperature Rise).
5. Since in circuits used at voltages over 280 V peak-to-peak the risk for an intrinsically active flammability after a capacitor breakdown (short circuit) increases, it is recommended that the power to the component is limited to 100 times the values mentioned in the table: “Heat Conductivity”
6. When using these capacitors as across-the-line capacitor in the input filter for mains applications the applicant must guarantee that the following conditions are fulfilled in any case (spikes and surge voltages from the mains included).
7. For continuous use as series connection with an impedance to the mains, please refer to application note www.vishay.com/doc?28153.



VOLTAGE CONDITIONS FOR 6 ABOVE		
ALLOWED VOLTAGES	T_{amb} ≤ 85 °C	85 °C < T_{amb} ≤ 105 °C
Maximum continuous RMS voltage	U _{RAC}	0.8 x U _{RAC}
Maximum temperature RMS-overvoltage (< 24 h)	1.25 x U _{RAC}	1.0 x U _{RAC}
Maximum peak voltage (V _{O-P}) (< 2 s)	1.6 x U _{RDC}	1.3 x U _{RDC}

INSPECTION REQUIREMENTS

General Notes

Sub-clause numbers of tests and performance requirements refer to the “Sectional Specification, Publication IEC 60384-2 and Specific Reference Data”.

GROUP C INSPECTION REQUIREMENTS		
SUB-CLAUSE NUMBER AND TEST	CONDITIONS	PERFORMANCE REQUIREMENTS
SUB-GROUP C1A PART OF SAMPLE OF SUB-GROUP C1		
4.1 Dimensions (detail)		As specified in chapter “General Data” of this specification
4.3.1 Initial measurements	Capacitance at 1 kHz Tangent of loss angle: for C ≤ 470 nF at 100 kHz or for C > 470 nF at 10 kHz	
4.3 Robustness of terminations	Tensile and bending	No visible damage
4.4 Resistance to soldering heat	Method: 1A Solder bath: 280 °C ± 5 °C Duration: 10 s	
4.14 Component solvent resistance	Isopropylalcohol at room temperature Method: 2 Immersion time: 5 min ± 0.5 min Recovery time: min. 1 h, max. 2 h	
4.4.2 Final measurements	Visual examination Capacitance Tangent of loss angle	No visible damage Legible marking ΔC/C ≤ 2 % of the value measured initially Increase of tan δ: ≤ 0.005 for: C ≤ 100 nF or ≤ 0.010 for: 100 nF < C ≤ 220 nF or ≤ 0.015 for: 220 nF < C ≤ 470 nF and ≤ 0.003 for: C > 470 nF Compared to values measured in 4.3.1
SUB-GROUP C1B PART OF SAMPLE OF SUB-GROUP C1		
4.6.1 Initial measurements	Capacitance at 1 kHz Tangent of loss angle: for C ≤ 470 nF at 100 kHz or for C > 470 nF at 10 kHz	
4.6 Rapid change of temperature	θA = lower category temperature θB = upper category temperature 5 cycles Duration t = 30 min Visual examination	No visible damage



GROUP C INSPECTION REQUIREMENTS		
SUB-CLAUSE NUMBER AND TEST	CONDITIONS	PERFORMANCE REQUIREMENTS
SUB-GROUP C1B PART OF SAMPLE OF SUB-GROUP C1		
4.7 Vibration	Mounting: see section "Mounting" of this specification Procedure B4 Frequency range: 10 Hz to 55 Hz Amplitude: 0.75 mm or Acceleration 98 m/s ² (whichever is less severe) Total duration 6 h	
4.7.2 Final inspection	Visual examination	No visible damage
4.9 Shock	Mounting: see section "Mounting" of this specification Pulse shape: half sine Acceleration: 490 m/s ² Duration of pulse: 11 ms	
4.9.3 Final measurements	Visual examination Capacitance Tangent of loss angle Insulation resistance	No visible damage $ \Delta C/C \leq 5\%$ of the value measured in 4.6.1 Increase of $\tan \delta$: ≤ 0.005 for: $C \leq 100$ nF or ≤ 0.010 for: 100 nF $< C \leq 220$ nF or ≤ 0.015 for: 220 nF $< C \leq 470$ nF and ≤ 0.003 for: $C > 470$ nF Compared to values measured in 4.6.1 As specified in section "Specific Reference Data" of this specification
SUB-GROUP C1 COMBINED SAMPLE OF SPECIMENS OF SUB-GROUPS C1A AND C1B		
4.10 Climatic sequence		
4.10.2 Dry heat	Temperature: upper category temperature Duration: 16 h	
4.10.3 Damp heat cyclic Test Db, first cycle		
4.10.4 Cold	Temperature: lower category temperature Duration: 2 h	
4.10.6 Damp heat cyclic Test Db, remaining cycles		
4.10.6.2 Final measurements	Visual examination Capacitance Tangent of loss angle Insulation resistance	No visible damage Legible marking $ \Delta C/C \leq 5\%$ of the value measured in 4.4.2 or 4.9.3 Increase of $\tan \delta$: ≤ 0.007 for: $C \leq 100$ nF or ≤ 0.010 for: 100 nF $< C \leq 220$ nF or ≤ 0.015 for: 220 nF $< C \leq 470$ nF and ≤ 0.005 for: $C > 470$ nF Compared to values measured in 4.3.1 or 4.6.1 $\geq 50\%$ of values specified in section "Specific Reference Data" of this specification



GROUP C INSPECTION REQUIREMENTS		
SUB-CLAUSE NUMBER AND TEST	CONDITIONS	PERFORMANCE REQUIREMENTS
SUB-GROUP C2		
4.11 Damp heat steady state	56 days, 40 °C, 90 % to 95 % RH	
4.11.1 Initial measurements	Capacitance at 1 kHz Tangent of loss angle at 1 kHz	
4.11.3 Final measurements	Visual examination Capacitance Tangent of loss angle Insulation resistance	No visible damage Legible marking $ \Delta C/C \leq 5\%$ of the value measured in 4.11.1. Increase of $\tan \delta \leq 0.005$ Compared to values measured in 4.11.1 $\geq 50\%$ of values specified in section "Specific Reference Data" of this specification
SUB-GROUP C3		
4.12 Endurance	Duration: 2000 h 1.25 x U_{RDC} at 85 °C 1.0 x U_{RDC} at 105 °C	
4.12.1 Initial measurements	Capacitance at 1 kHz Tangent of loss angle: for $C \leq 470$ nF at 100 kHz or for $C > 470$ nF at 10 kHz	
4.12.5 Final measurements	Visual examination Capacitance Tangent of loss angle Insulation resistance	No visible damage Legible marking $ \Delta C/C \leq 5\%$ compared to values measured in 4.12.1 Increase of $\tan \delta$: ≤ 0.005 for: $C \leq 100$ nF or ≤ 0.010 for: 100 nF $< C \leq 220$ nF or ≤ 0.015 for: 220 nF $< C \leq 470$ nF and ≤ 0.003 for: $C > 470$ nF Compared to values measured in 4.12.1 $\geq 50\%$ of values specified in section "Specific Reference Data" of this specification
SUB-GROUP C4		
4.13 Charge and discharge	10 000 cycles Charged to U_{RDC} Discharge resistance: $R = \frac{U_R}{C \times 2.5 \times (dU/dt)_R}$	
4.13.1 Initial measurements	Capacitance at 1 kHz Tangent of loss angle: for $C \leq 470$ nF at 100 kHz or for $C > 470$ nF at 10 kHz	
4.13.3 Final measurements	Capacitance Tangent of loss angle Insulation resistance	$ \Delta C/C \leq 3\%$ compared to values measured in 4.13.1 Increase of $\tan \delta$: ≤ 0.005 for: $C \leq 100$ nF or ≤ 0.010 for: 100 nF $< C \leq 220$ nF or ≤ 0.015 for: 220 nF $< C \leq 470$ nF and ≤ 0.003 for: $C > 470$ nF Compared to values measured in 4.13.1 $\geq 50\%$ of values specified in section "Specific Reference Data" of this specification



Disclaimer

ALL PRODUCT, PRODUCT SPECIFICATIONS AND DATA ARE SUBJECT TO CHANGE WITHOUT NOTICE TO IMPROVE RELIABILITY, FUNCTION OR DESIGN OR OTHERWISE.

Vishay Intertechnology, Inc., its affiliates, agents, and employees, and all persons acting on its or their behalf (collectively, "Vishay"), disclaim any and all liability for any errors, inaccuracies or incompleteness contained in any datasheet or in any other disclosure relating to any product.

Vishay makes no warranty, representation or guarantee regarding the suitability of the products for any particular purpose or the continuing production of any product. To the maximum extent permitted by applicable law, Vishay disclaims (i) any and all liability arising out of the application or use of any product, (ii) any and all liability, including without limitation special, consequential or incidental damages, and (iii) any and all implied warranties, including warranties of fitness for particular purpose, non-infringement and merchantability.

Statements regarding the suitability of products for certain types of applications are based on Vishay's knowledge of typical requirements that are often placed on Vishay products in generic applications. Such statements are not binding statements about the suitability of products for a particular application. It is the customer's responsibility to validate that a particular product with the properties described in the product specification is suitable for use in a particular application. Parameters provided in datasheets and / or specifications may vary in different applications and performance may vary over time. All operating parameters, including typical parameters, must be validated for each customer application by the customer's technical experts. Product specifications do not expand or otherwise modify Vishay's terms and conditions of purchase, including but not limited to the warranty expressed therein.

Hyperlinks included in this datasheet may direct users to third-party websites. These links are provided as a convenience and for informational purposes only. Inclusion of these hyperlinks does not constitute an endorsement or an approval by Vishay of any of the products, services or opinions of the corporation, organization or individual associated with the third-party website. Vishay disclaims any and all liability and bears no responsibility for the accuracy, legality or content of the third-party website or for that of subsequent links.

Vishay products are not designed for use in life-saving or life-sustaining applications or any application in which the failure of the Vishay product could result in personal injury or death unless specifically qualified in writing by Vishay. Customers using or selling Vishay products not expressly indicated for use in such applications do so at their own risk. Please contact authorized Vishay personnel to obtain written terms and conditions regarding products designed for such applications.

No license, express or implied, by estoppel or otherwise, to any intellectual property rights is granted by this document or by any conduct of Vishay. Product names and markings noted herein may be trademarks of their respective owners.