

DO NOT
SCALE FROM
THIS PRINT

TABLE 1			
ITEM	COMPONENT	-HN	-GN
1	HEX NUT	BTNC-NUT-001-N	
2	LOCK WASHER	BTNC-LWAS-001-N	
3	GASKET	BTNC-GKT-001	
4	SUB ASSEMBLY	SUB-BNC7T-J-C-N-ST-BH3	
5	SOCKET	BNC7T-SKT-003-H	BNC7T-SKT-003-G
6	INSULATOR	BNC7-INS-001	
7	INNER FERRULE	BTNC-FER-001-N	
8	OUTER FERRULE	BNC-FER-002-N	

BNC7T-J-C-XX-ST-BH3

GENDER
-J: JACK

TYPE
-C: CABLE

TERMINATION
-BH3: BULKHEAD CABLE
(RG179)

ORIENTATION
-ST: STRAIGHT

PLATING SPECIFICATION

-HN: 30µ" GOLD CENTER CONTACT,
100µ" NICKEL OUTER CONTACT
-GN: 10µ" GOLD CENTER CONTACT,
100µ" NICKEL OUTER CONTACT
(SEE TABLE 1)

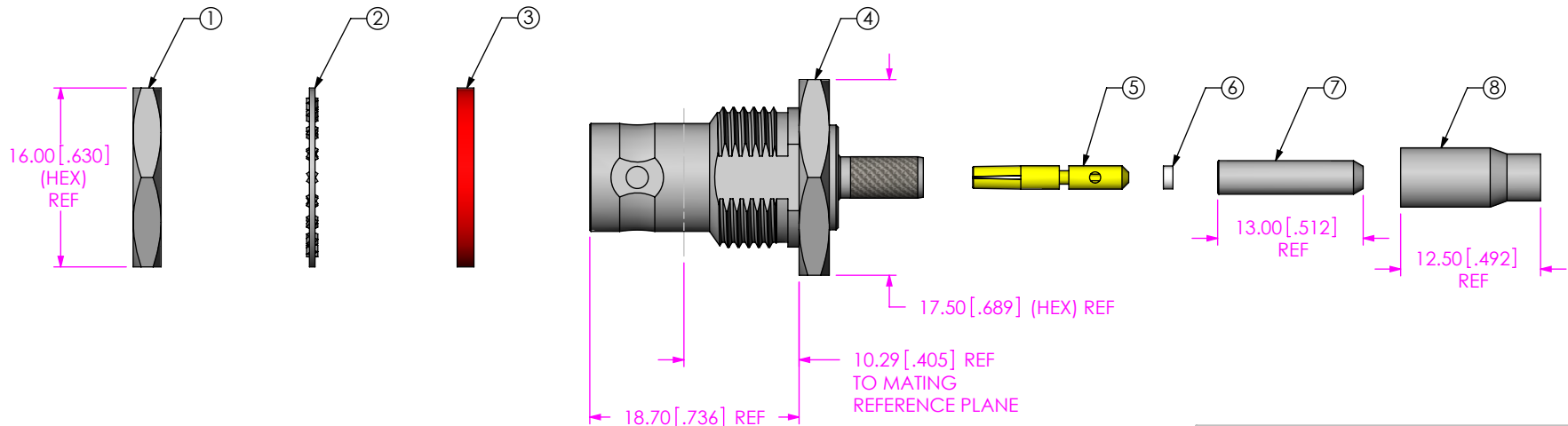

RECOMMENDED MOUNTING HOLE
4.00 [.157] MAX PANEL THICKNESS

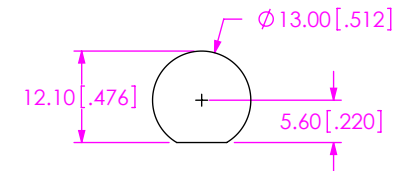

NOTES:

1. NOTE DELETED.
2. NOTE DELETED.
3. NOTE DELETED.
4. NOTE DELETED.
5. NOTE DELETED.
6. NOTE DELETED.
7. NOTE DELETED.
8. NOTE DELETED.

UNLESS OTHERWISE SPECIFIED,
DIMENSIONS ARE IN
MILLIMETERS [INCHES].
TOLERANCES ARE:

DECIMALS ANGLES
.X: ±0.3 [.01] 5°
.XX: ±0.13 [.005]
.XXX: ±0.051 [.0020]

PROPRIETARY NOTE

THIS DOCUMENT CONTAINS CONFIDENTIAL AND
PROPRIETARY INFORMATION AND ALL DESIGN,
MANUFACTURING, REPRODUCTION, USE, PATENT RIGHTS
AND SALES RIGHTS ARE EXPRESSLY RESERVED BY SAMTEC,
INC. THIS DOCUMENT SHALL NOT BE DISCLOSED, IN WHOLE
OR PART, TO ANY UNAUTHORIZED PERSON OR ENTITY NOR
REPRODUCED, TRANSFERRED OR INCORPORATED IN ANY
OTHER PROJECT IN ANY MANNER WITHOUT THE EXPRESS
WRITTEN CONSENT OF SAMTEC, INC.

MATERIAL: DO NOT SCALE DRAWING SHEET SCALE: 2:1
SHELL, FERRULES, NUT, WASHER: BRASS
CONTACT: COPPER ALLOY
DIELECTRIC: PTFE
GASKET: SILICONE



520 PARK EAST BLVD, NEW ALBANY, IN 47150
PHONE: 812-944-6733 FAX: 812-948-5047
e-Mail: info@SAMTEC.com code: 55322

DESCRIPTION:
TRUE 75 OHM, BNC STRAIGHT JACK, RG 179

DWG. NO.
BNC7T-J-C-XX-ST-BH3

BY: G HERMAN 06/25/2008 SHEET 1 OF 2

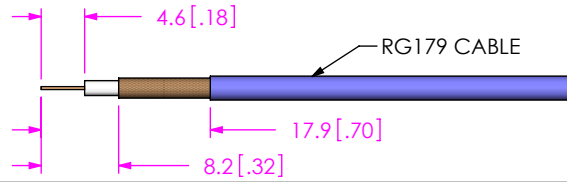

IN PROCESS 1
STRIP CABLE AND TIN INNER
CONDUCTOR

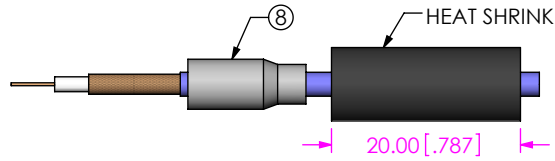

IN PROCESS 2
ADD HEAT SHRINK
TUBING AND OUTER FERRULE

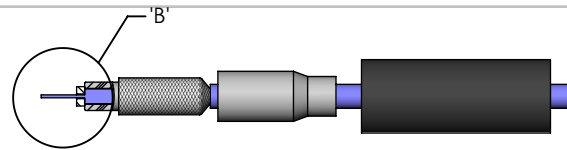

IN PROCESS 3
FLARE SHIELD, ADD INNER
FERRULE AND INSULATOR

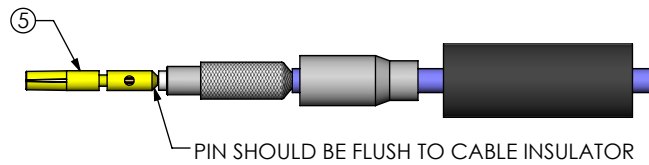

IN PROCESS 4
SOLDER SIGNAL SOCKET

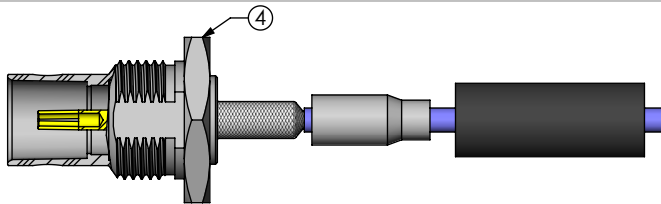

IN PROCESS 5
FLARE SHIELD &
ADD SUB ASSEMBLY

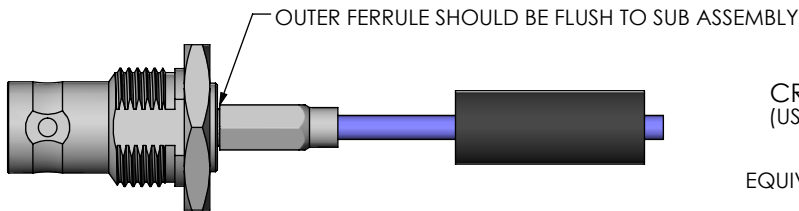

IN PROCESS 6
CRIMP OUTER FERRULE
(USE RF CRIMP HAND TOOL
#CAT-RF-FER-01
OR
EQUIVALENT AND .178" DIE SIZE)

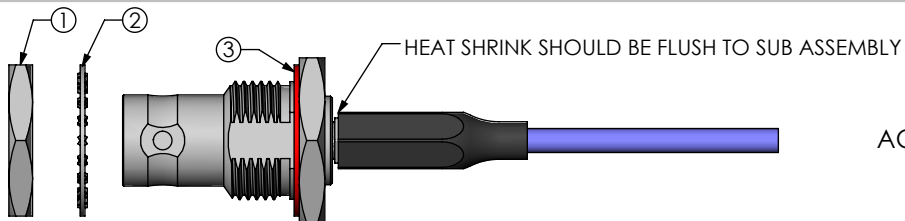

IN PROCESS 7
ACTIVATE HEAT SHRINK
& ADD GASKET

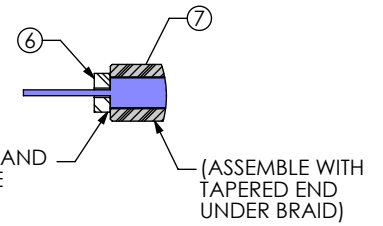

DETAIL 'B'
SCALE 2.5 : 1

c:\enterprise\vault\DWG\MISC\MKTG\BNC7T-J-C-XX-ST-BH3-MKT.SLDDRW

PROPRIETARY NOTE
THIS DOCUMENT CONTAINS CONFIDENTIAL AND PROPRIETARY INFORMATION AND ALL DESIGN, MANUFACTURING, REPRODUCTION, USE, PATENT RIGHTS AND SALES RIGHTS ARE EXPRESSLY RESERVED BY SAMTEC, INC. THIS DOCUMENT SHALL NOT BE DISCLOSED, IN WHOLE OR PART, TO ANY UNAUTHORIZED PERSON OR ENTITY NOR REPRODUCED, TRANSFERRED OR INCORPORATED IN ANY OTHER PROJECT IN ANY MANNER WITHOUT THE EXPRESS WRITTEN CONSENT OF SAMTEC, INC.



520 PARK EAST BLVD, NEW ALBANY, IN 47150
PHONE: 812-944-6733 FAX: 812-948-5047
e-Mail: info@SAMTEC.com code: 55322

DO NOT SCALE DRAWING

SHEET SCALE: 5:4

DESCRIPTION:
TRUE 75 OHM, BNC STRAIGHT JACK, RG 179

DWG. NO.
BNC7T-J-C-XX-ST-BH3

BY: G HERMAN 06/25/2008 SHEET 2 OF 2