

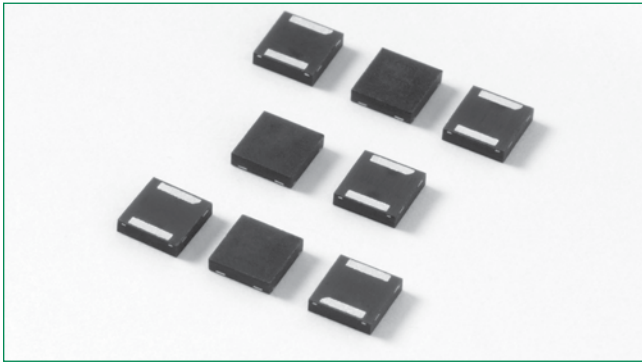

### Q2L Series - 3.3x3.3 QFN



#### Agency Approvals

| Agency  | Agency File Number |
|---|--------------------|
|  | E133083            |

#### Schematic Symbol

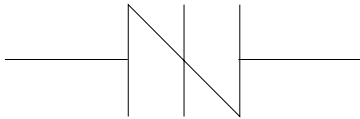

#### Additional Information



Datasheet



Resources



Samples

#### Description

Q2L Series 3.3x3.3 QFN are low capacitance SIDACtor<sup>®</sup> devices designed to protect high density broadband equipment from damaging overvoltage transients.

The series provides a low profile, chip scale surface mount solution that enables broadband equipment to comply with global regulatory standards while limiting the impact to broadband signals and board space.

#### Features and Benefits

- Low profile
- Small footprint
- Low capacitance
- Low voltage overshoot
- Low on-state voltage
- Does not degrade surge capability after multiple surge events within limit.
- Fails short circuit when surged in excess of ratings
- 2nd level interconnect is Pb-free per IPC/JEDEC J-STD-609A.01
- Recognized to UL 497B as an Isolated Loop Circuit Protector

#### Applicable Global Standards

- TIA-968-A
- TIA-968-B
- ITU K.20/21 Enhanced Level
- ITU K.20/21 Basic Level
- GR 1089 Inter-building
- GR 1089 Intra-building
- IEC 61000-4-5
- YD/T 1082
- YD/T 993
- YD/T 950

#### Electrical Characteristics

| Part Number  | Marking | $V_{DRM}$<br>@ $I_{DRM} = 5\mu A$ | $V_S$<br>@ $100V/\mu s$ | $I_H$  | $I_S$  | $I_T$ | $V_T @ I_T = 2.2 \text{ Amps}$ | Capacitance<br>@ 1MHz, 2V bias |        |
|--------------|---------|-----------------------------------|-------------------------|--------|--------|-------|--------------------------------|--------------------------------|--------|
|              |         | V min                             | V max                   | mA min | mA max | A max | V max                          | pF min                         | pF max |
| P0080Q22CLRP | P-8C    | 6                                 | 25                      | 50     | 800    | 2.2   | 5                              | 35                             | 75     |
| P0300Q22CLRP | P03C    | 25                                | 40                      | 50     | 800    | 2.2   | 5                              | 25                             | 45     |
| P0640Q22CLRP | P06C    | 58                                | 77                      | 150    | 800    | 2.2   | 5                              | 55                             | 85     |
| P0720Q22CLRP | P07C    | 65                                | 88                      | 150    | 800    | 2.2   | 5                              | 50                             | 75     |
| P0900Q22CLRP | P09C    | 75                                | 98                      | 150    | 800    | 2.2   | 5                              | 45                             | 70     |
| P1100Q22CLRP | P11C    | 90                                | 130                     | 150    | 800    | 2.2   | 5                              | 45                             | 70     |
| P1200Q22CLRP | P12C    | 100                               | 130                     | 150    | 800    | 2.2   | 5                              | 45                             | 70     |
| P1300Q22CLRP | P13C    | 120                               | 160                     | 150    | 800    | 2.2   | 5                              | 40                             | 60     |
| P1500Q22CLRP | P15C    | 140                               | 180                     | 150    | 800    | 2.2   | 5                              | 35                             | 55     |
| P1800Q22CLRP | P18C    | 170                               | 220                     | 150    | 800    | 2.2   | 5                              | 35                             | 50     |
| P2000Q22CLRP | P20C    | 180                               | 220                     | 150    | 800    | 2.2   | 5                              | 30                             | 50     |
| P2300Q22CLRP | P23C    | 190                               | 260                     | 150    | 800    | 2.2   | 5                              | 30                             | 50     |
| P2500Q22CLRP | P25C    | 230                               | 290                     | 150    | 800    | 2.2   | 5                              | 30                             | 50     |
| P2600Q22CLRP | P26C    | 220                               | 300                     | 150    | 800    | 2.2   | 5                              | 30                             | 45     |
| P3100Q22CLRP | P31C    | 275                               | 350                     | 150    | 800    | 2.2   | 5                              | 30                             | 45     |
| P3500Q22CLRP | P35C    | 320                               | 400                     | 150    | 800    | 2.2   | 5                              | 25                             | 40     |
| P4500Q22CLRP | P45C    | 400                               | 530                     | 150    | 800    | 2.2   | 5                              | 25                             | 45     |

#### Notes:

- Absolute maximum ratings measured at  $T_A = 25^\circ C$  (unless otherwise noted).
- Devices are bi-directional (unless otherwise noted).

**Surge Ratings**

| Series | 2x10 <sup>1</sup><br>2x10 <sup>2</sup> | 8x20 <sup>1</sup><br>1.2x50 <sup>2</sup> | 10x160 <sup>1</sup><br>10x160 <sup>2</sup> | 10x560 <sup>1</sup><br>10x560 <sup>2</sup> | 10x1000 <sup>1</sup><br>10x1000 <sup>2</sup> | 5x310 <sup>1</sup><br>10x700 <sup>2</sup> | I <sub>TSM</sub><br>50/60 Hz | di/dt    |
|--------|--|--|--|--|--|---|------------------------------|----------|
|        | A min                                  | A min                                    | A min                                      | A min                                      | A min  | A min                                     | A min                        | A/μs max |
| C      | 500                                    | 400                                      | 200  | 150  | 100  | 200 <sup>3</sup>                          | 30                           | 500      |

**Notes:**

1. Current waveform in μs
  2. Voltage waveform in μs
  3. For surge rating of P4500Q22CLRP 10x700μs min=150A & typical=180A
- Peak pulse current rating (I<sub>pp</sub>) is repetitive and guaranteed for the life of the product.
  - I<sub>pp</sub> ratings applicable over temperature range of -40°C to +85°C
  - The device must initially be in thermal equilibrium with -40°C ≤ T<sub>j</sub> ≤ +150°C

**Thermal Considerations**

| Package  | Symbol           | Parameter                               | Value       | Unit |
|--|------------------|---|-------------|------|
| 3.3 x 3.3 QFN<br> | T <sub>j</sub>   | Operating Junction Temperature Range    | -40 to +150 | °C   |
|  | T <sub>s</sub>   | Storage Temperature Range               | -65 to +150 | °C   |
|  | R <sub>θJA</sub> | Thermal Resistance: Junction to Ambient | 120         | °C/W |

**V-I Characteristics**

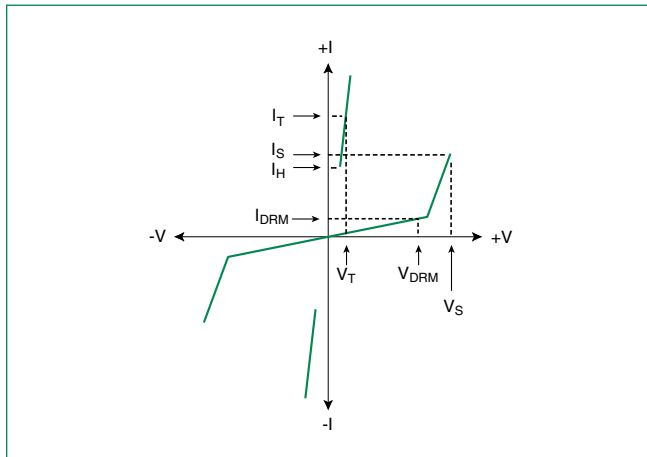

**t<sub>r</sub> x t<sub>d</sub> Pulse Waveform**

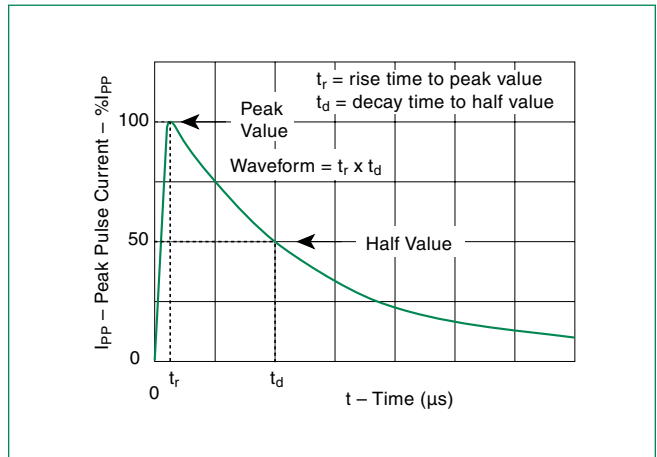

**Normalized V<sub>s</sub> Change vs. Junction Temperature**

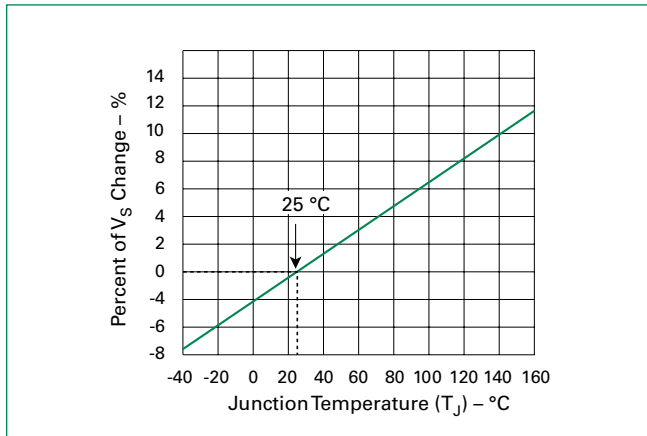

**Normalized DC Holding Current vs. Case Temperature**

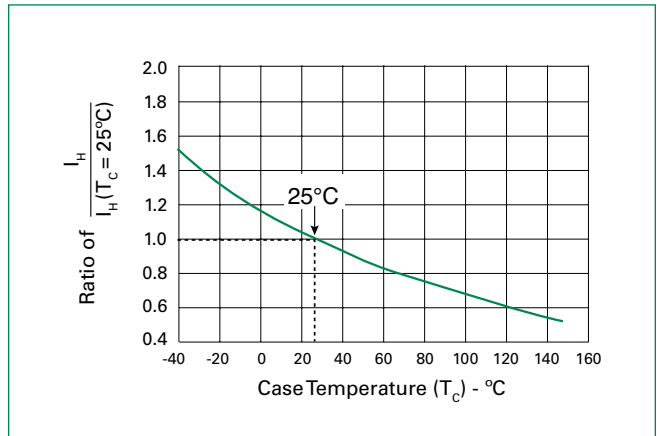

**Soldering Parameters**

|  |                                    |                  |
|--|------------------------------------|------------------|
| <b>Reflow Condition</b>  |                                    | Pb-Free assembly |
| <b>Pre Heat</b>  | - Temperature Min ( $T_{s(min)}$ ) | +150°C           |
|  | - Temperature Max ( $T_{s(max)}$ ) | +200°C           |
|  | - Time (Min to Max) ( $t_s$ )      | 60-180 secs.     |
| <b>Average ramp up rate (Liquidus Temp (<math>T_L</math>) to peak)</b> |                                    | 3°C/sec. Max.    |
| <b><math>T_{s(max)}</math> to <math>T_L</math> - Ramp-up Rate</b>      |                                    | 3°C/sec. Max.    |
| <b>Reflow</b>  | - Temperature ( $T_L$ ) (Liquidus) | +217°C           |
|  | - Temperature ( $t_L$ )            | 60-150 secs.     |
| <b>Peak Temp (<math>T_p</math>)</b>                                    |                                    | +260(+0/-5)°C    |
| <b>Time within 5°C of actual Peak Temp (<math>t_p</math>)</b>          |                                    | 30 secs. Max.    |
| <b>Ramp-down Rate</b>  |                                    | 6°C/sec. Max.    |
| <b>Time 25°C to Peak Temp (<math>T_p</math>)</b>                       |                                    | 8 min. Max.      |
| <b>Do not exceed</b>   |                                    | +260°C           |

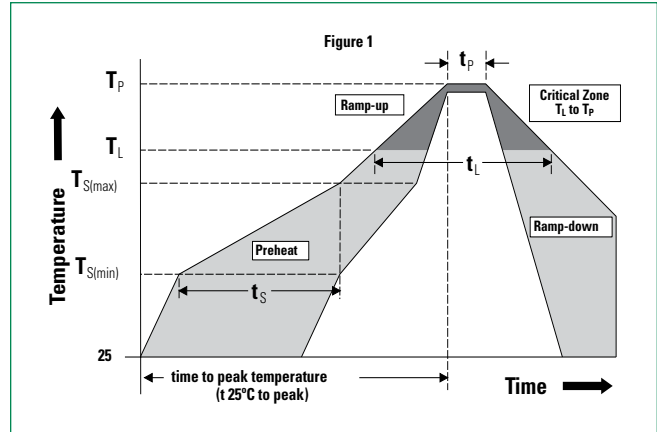

**Physical Specifications**

|                        |   |
|------------------------|---|
| <b>Lead Material</b>   | Copper Alloy  |
| <b>Terminal Finish</b> | 100% Matte-Tin Plated   |
| <b>Body Material</b>   | UL recognized epoxy meeting flammability classification 94V-0 |

**Environmental Specifications**

|                                   |  |
|-----------------------------------|--|
| <b>High Temp Voltage Blocking</b> | 80% Rated $V_{DRM}$ ( $V_{AC Peak}$ ) +125°C or +150°C, 504 or 1008 hrs. MIL-STD-750 (Method 1040) JEDEC, JESD22-A-101 |
| <b>Temp Cycling</b>               | -65°C to +150°C, 15 min. dwell, 10 up to 100 cycles. MIL-STD-750 (Method 1051) EIA/JEDEC, JESD22-A-104                 |
| <b>Biased Temp &amp; Humidity</b> | 52 $V_{DC}$ (+85°C) 85%RH, 504 up to 1008 hrs. EIA/JEDEC, JESD22-A-101   |
| <b>High Temp Storage</b>          | +150°C 1008 hrs. MIL-STD-750 (Method 1031) JEDEC, JESD22-A-101   |
| <b>Low Temp Storage</b>           | -65°C, 1008 hrs.   |
| <b>Thermal Shock</b>              | 0°C to +100°C, 5 min. dwell, 10 sec. transfer, 10 cycles. MIL-STD-750 (Method 1056) JEDEC, JESD22-A-106                |
| <b>Resistance to Solder Heat</b>  | +260°C, 30 secs. MIL-STD-750 (Method 2031)   |
| <b>Moisture Sensitivity Level</b> | 85%RH, +85°C, 168 hrs., 3 reflow cycles (+260°C Peak). JEDEC-J-STD-020, Level 1  |

**Dimensions — 3.3x3.3 QFN**

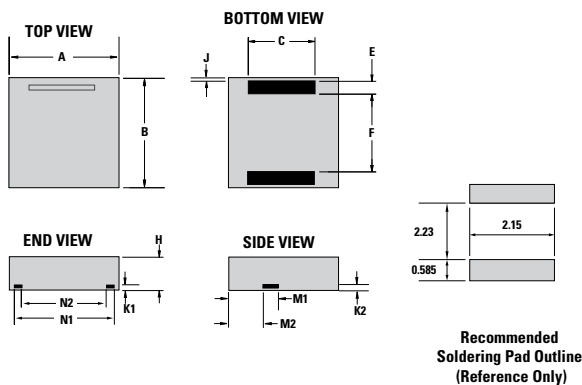

| Dimensions | Inches |       | Millimeters |       |
|------------|--------|-------|-------------|-------|
|            | Min    | Max   | Min         | Max   |
| <b>A</b>   | 0.126  | 0.134 | 3.200       | 3.400 |
| <b>B</b>   | 0.126  | 0.134 | 3.200       | 3.400 |
| <b>C</b>   | 0.075  | 0.083 | 1.900       | 2.100 |
| <b>E</b>   | 0.011  | 0.019 | 0.285       | 0.485 |
| <b>F</b>   | 0.088  | 0.096 | 2.230       | 2.430 |
| <b>H</b>   | 0.035  | 0.043 | 0.900       | 1.100 |
| <b>J</b>   | 0.000  | 0.008 | 0.000       | 0.200 |
| <b>K1</b>  | 0.004  | 0.012 | 0.100       | 0.300 |
| <b>K2</b>  | 0.004  | 0.012 | 0.100       | 0.300 |
| <b>M1</b>  | 0.063  | 0.071 | 1.610       | 1.810 |
| <b>M2</b>  | 0.045  | 0.053 | 1.153       | 1.353 |
| <b>N1</b>  | 0.095  | 0.103 | 2.420       | 2.620 |
| <b>N2</b>  | 0.082  | 0.090 | 2.080       | 2.280 |

**Part Numbering**

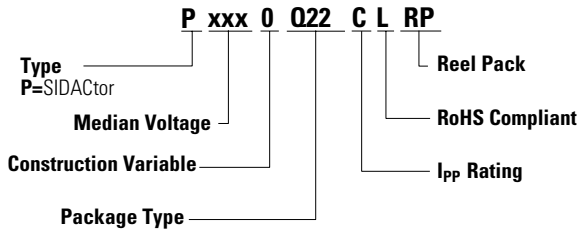

**Part Marking**

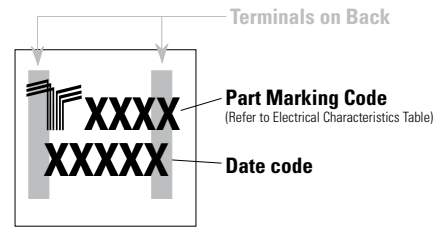

**Packing Options**

| Package Type | Description                    | Quantity | Added Suffix | Industry Standard |
|--------------|--------------------------------|----------|--------------|-------------------|
| Q22          | 3.3x3.3 QFN Tape and Reel Pack | 5000     | RP           | EIA-481-D         |

**Tape and Reel Specifications — 3.3x3.3 QFN**

**Reel Dimension**

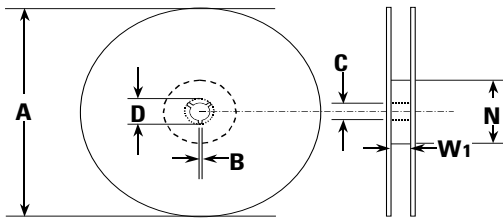

**Tape Leader and Trailer Dimensions**

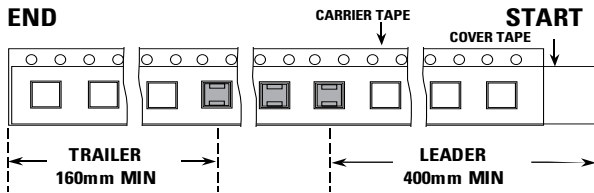

**Tape Dimension Items**

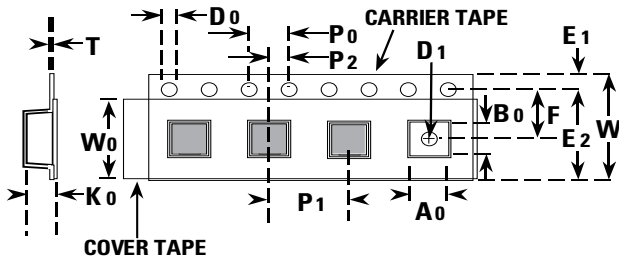

| Symbols        | Description                             | Inches |        | Millimeters |       |
|----------------|---|--------|--------|-------------|-------|
|                |   | Min    | Max    | Min         | Max   |
| A              | Reel Diameter                           | N/A    | 12.992 | N/A         | 330.0 |
| B              | Drive Spoke Width                       | 0.059  | N/A    | 1.50        | N/A   |
| C              | Arbor Hole Diameter                     | 0.504  | 0.531  | 12.80       | 13.50 |
| D              | Drive Spoke Diameter                    | 0.795  | N/A    | 20.20       | N/A   |
| N              | Hub Diameter                            | 1.969  | N/A    | 50.00       | N/A   |
| W <sub>1</sub> | Reel Inner Width at Hub                 | 0.488  | 0.567  | 12.40       | 14.40 |
| A <sub>0</sub> | Pocket Width at Bottom                  | 0.138  | 0.146  | 3.50        | 3.70  |
| B <sub>0</sub> | Pocket Length at Bottom                 | 0.138  | 0.146  | 3.50        | 3.70  |
| D <sub>0</sub> | Feed Hole Diameter                      | 0.059  | 0.063  | 1.50        | 1.60  |
| D <sub>1</sub> | Pocket Hole Diameter                    | 0.059  | N/A    | 1.50        | N/A   |
| E <sub>1</sub> | Feed Hole Position 1                    | 0.065  | 0.073  | 1.65        | 1.85  |
| E <sub>2</sub> | Feed Hole Position 2                    | 0.400  | 0.408  | 10.15       | 10.35 |
| F              | Feed Hole Center - Pocket Hole Center 2 | 0.215  | 0.219  | 5.45        | 5.55  |
| K <sub>0</sub> | Pocket Depth                            | 0.039  | 0.051  | 1.00        | 1.30  |
| P <sub>0</sub> | Feed Hole Pitch                         | 0.153  | 0.161  | 3.90        | 4.10  |
| P <sub>1</sub> | Component Spacing                       | 0.311  | 0.319  | 7.90        | 8.10  |
| P <sub>2</sub> | Feed Hole Center - Pocket Hole Center 1 | 0.077  | 0.081  | 1.90        | 2.05  |
| T              | Carrier Tape Thickness                  | 0.010  | 0.014  | 0.25        | 0.35  |
| W              | Embossed Carrier Tape Width             | 0.453  | 0.484  | 11.50       | 12.30 |
| W <sub>0</sub> | Cover Tape Width                        | 0.358  | 0.366  | 9.10        | 9.30  |