

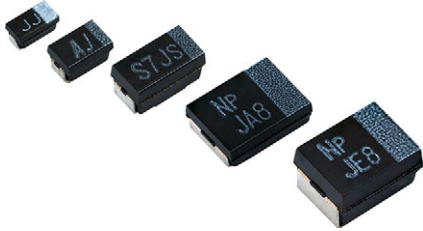

vPolyTan™ Polymer Surface-Mount Chip Capacitors, Molded Case, High Performance Type



FEATURES

- Ultra low ESR
- 100 % surge current tested
- Accelerated voltage conditioning
- High ripple current capability
- Stable capacitance over operating temperature, voltage, and frequency range
- No wear out effect
- Molded case available in 9 case codes
- Terminations:
cases C, J, P: 100 % tin
case A, T, B, Z, V, D: Ni / Pd / Au
- Compatible with “high volume” automatic pick and place equipment
- Moisture sensitivity level 3
- Material categorization: for definitions of compliance please see www.vishay.com/doc?99912



RoHS
COMPLIANT
HALOGEN
FREE
GREEN
(5-2008)

LINKS TO ADDITIONAL RESOURCES



PERFORMANCE / ELECTRICAL CHARACTERISTICS

Operating Temperature: -55 °C to +105 °C / +125 °C
(above 105 °C, additional voltage derating is required)

Capacitance Range: 3.3 µF to 1000 µF

Capacitance Tolerance: ± 20 %

Voltage Rating: 2.5 V_{DC} to 63 V_{DC}

APPLICATIONS

- Decoupling, smoothing, filtering
- Bulk energy storage in wireless cards
- Infrastructure equipment
- Storage and networking
- Computer motherboards
- Smartphones and tablets

ORDERING INFORMATION						
T55	A	156	M	6R3	C	0500
TYPE	CASE CODE	CAPACITANCE	CAPACITANCE TOLERANCE	DC VOLTAGE RATING	TERMINATION / PACKAGING	ESR
	See Ratings and Case Codes table	This is expressed in picofarads. The first two digits are the significant figures. The third is the number of zeros to follow.	M = ± 20 %	2R5 = 2.5 V 004 = 4 V 6R3 = 6.3 V 007 = 7 V 010 = 10 V 12R = 12.5 V 016 = 16 V 020 = 20 V 025 = 25 V 035 = 35 V 050 = 50 V 063 = 63 V	C = lead (Pb)-free solderable coating, 7" reel	Maximum 100 kHz ESR in mΩ

DIMENSIONS in inches [millimeters]

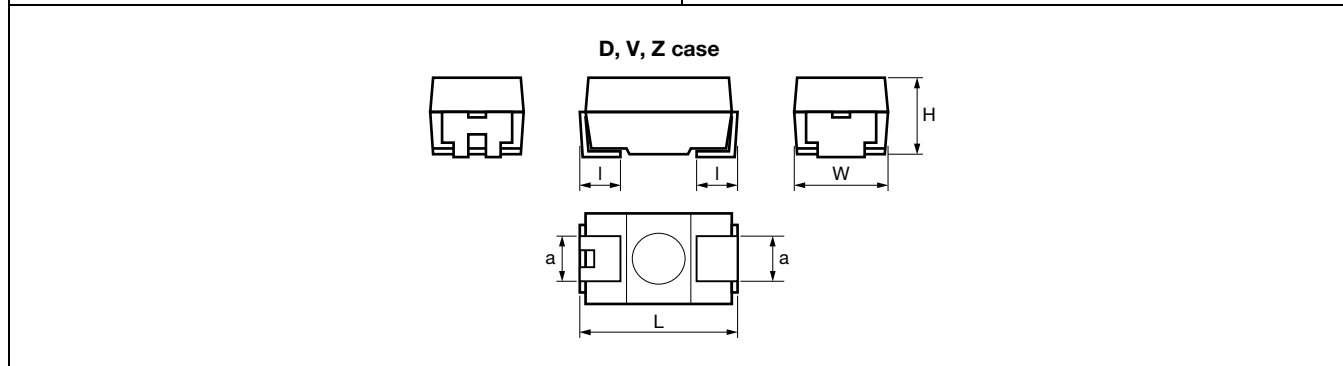
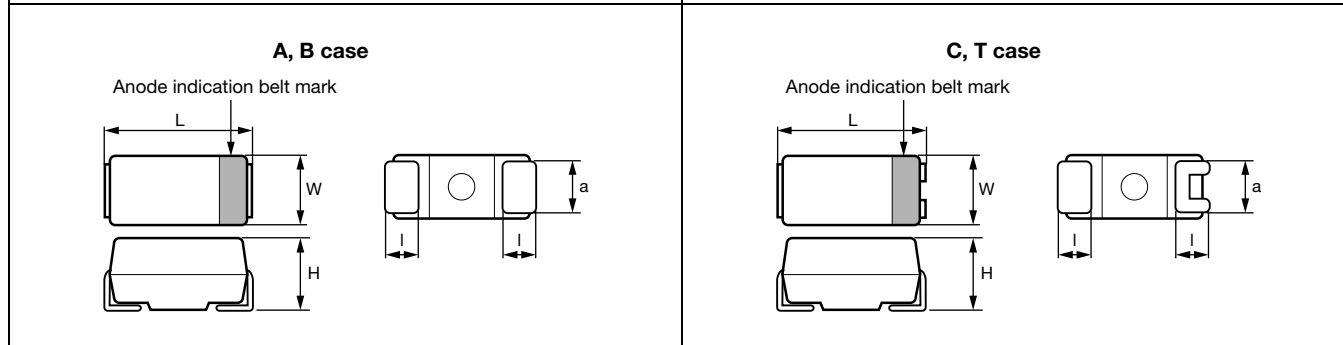
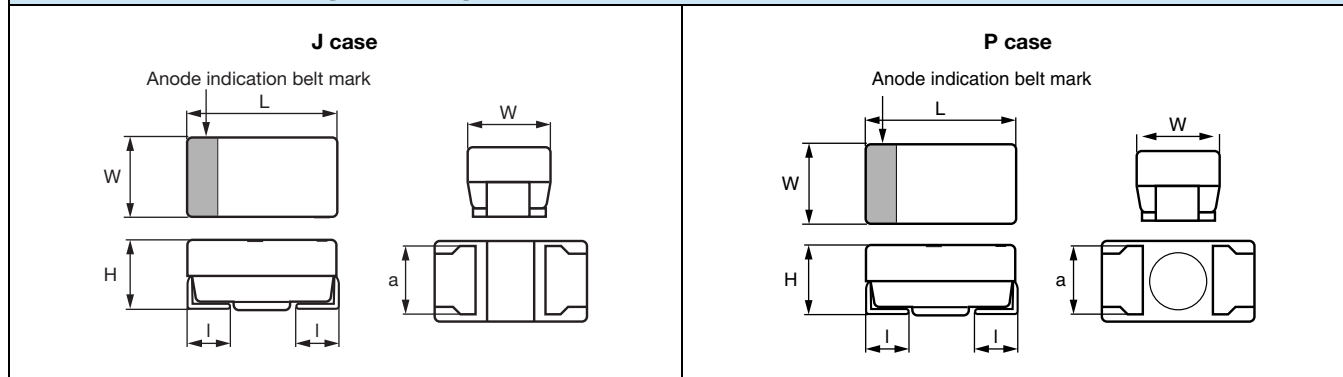

CASE CODE	EIA SIZE	L	W	H	l	a
J	1608-09	0.063 ± 0.004 [1.6 ± 0.1]	0.031 ± 0.004 [0.8 ± 0.1]	0.031 ± 0.004 [0.8 ± 0.1]	0.012 ± 0.006 [0.3 ± 0.15]	0.024 ± 0.004 [0.6 ± 0.1]
P	2012-12	0.080 ± 0.008 [2.0 ± 0.2]	0.049 ± 0.008 [1.25 ± 0.2]	0.047 max. [1.2 max.]	0.020 ± 0.008 [0.5 ± 0.2]	0.035 ± 0.004 [0.9 ± 0.1]
A	3216-18	0.126 ± 0.008 [3.2 ± 0.2]	0.063 ± 0.008 [1.6 ± 0.2]	0.063 ± 0.008 [1.6 ± 0.2]	0.028 ± 0.012 [0.7 ± 0.3]	0.047 ± 0.008 [1.2 ± 0.2]
T	3528-12	0.138 ± 0.008 [3.5 ± 0.2]	0.110 ± 0.008 [2.8 ± 0.2]	0.047 max. [1.2 max.]	0.030 ± 0.012 [0.8 ± 0.3]	0.087 ± 0.008 [2.2 ± 0.2]
B	3528-20	0.138 ± 0.008 [3.5 ± 0.2]	0.110 ± 0.008 [2.8 ± 0.2]	0.075 ± 0.004 [1.9 ± 0.1]	0.030 ± 0.012 [0.8 ± 0.3]	0.087 ± 0.008 [2.2 ± 0.2]
C	6032-28	0.228 ± 0.008 [5.8 ± 0.2]	0.126 ± 0.008 [3.2 ± 0.2]	0.100 ± 0.008 [2.5 ± 0.2]	0.051 ± 0.012 [1.3 ± 0.3]	0.087 ± 0.008 [2.2 ± 0.2]
Z	7343-19	0.287 ± 0.008 [7.3 ± 0.2]	0.169 ± 0.012 [4.3 ± 0.3]	0.071 ± 0.004 [1.8 ± 0.1]	0.051 ± 0.012 [1.3 ± 0.3]	0.094 ± 0.008 [2.4 ± 0.2]
V	7343-20	0.287 ± 0.008 [7.3 ± 0.2]	0.169 ± 0.012 [4.3 ± 0.3]	0.075 ± 0.004 [1.9 ± 0.1]	0.051 ± 0.012 [1.3 ± 0.3]	0.094 ± 0.008 [2.4 ± 0.2]
D	7343-31	0.287 ± 0.008 [7.3 ± 0.2]	0.169 ± 0.012 [4.3 ± 0.3]	0.110 ± 0.012 [2.8 ± 0.3]	0.051 ± 0.012 [1.3 ± 0.3]	0.094 ± 0.008 [2.4 ± 0.2]



RATINGS AND CASE CODES												
μF	2.5 V	4.0 V	6.3 V	7.0 V	10 V	12.5 V	16 V	20 V	25 V	35 V	50 V	63 V
1.0												B
2.2										B	B	
3.3			J/P		J/P							
4.7			J/P/A		P/A					B		C/D
6.8			P/A		A		B		B	B		
10		J/P/A	P/A		P/A		B		B	B/D	D	D
15		P/A	A		A	T	B	B/V	B/V	V	D	
22	A	A/B	A/T/B		A/T/B		B	V	V	Z/V/D		
33	A	A/B	A/T/B		A/T/B		B/V/D	V	Z/V/D	D		
47	A	A/T/B	A/T/B		B		Z/V/D	Z/V	D	D		
68	A/B	A/T/B	T/B		V		V		D			
100	A/T/B	A/T/B	A/T/B/ Z/V/D	A	Z/V/D		Z/V/D	D	D			
150	B	B/Z/V	B/Z/V/D		Z/V/D		D					
220	B/V	B/Z/V/D	B/Z/V/D		Z/V/D							
330	B/Z/V/D	Z/V/D	V/D		D							
470	B/Z/V/D	Z/D	V/D	D								
680	D	D	D									
1000	D											

MARKING

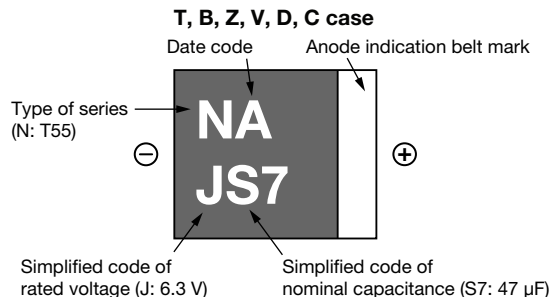
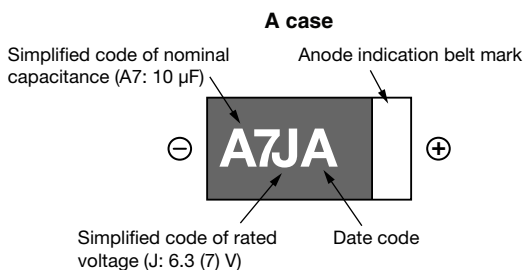

VOLTAGE CODE		CAPACITANCE CODE	
V	CODE	CAP, μF	CODE
2.5	e	1.0	A6
4	G	1.5	E6
6.3 (7)	J	2.2	J6
10	A	3.3	N6
12.5	B	4.7	S6
16	C	6.8	W6
20	D	10	A7
25	E	15	E7
35	V	22	J7
50	H	33	N7
63	J	47	S7
		68	W7
		100	A8
		150	E8
		220	J8
		330	N8
		470	S8
		680	W8
		1000	A9



MARKING

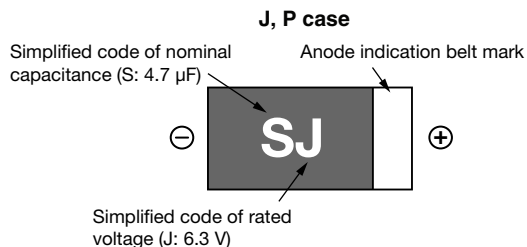

RATED VOLTAGE	CAPACITANCE	MARKING
4	10	AG
4	15	EG
6.3	3.3	NJ
6.3	4.7	SJ
6.3	6.8	WJ
6.3	10	AJ
10	3.3	NA
10	4.7	SA
10	10	AA

DATE CODE

YEAR	MONTH											
	1	2	3	4	5	6	7	8	9	10	11	12
2021	A	B	C	D	E	F	G	H	J	K	L	M
2022	N	P	Q	R	S	T	U	V	W	X	Y	Z
2023	a	b	c	d	e	f	g	h	j	k	l	m
2024	n	p	q	r	s	t	u	v	w	x	y	z
2025	A	B	C	D	E	F	G	H	J	K	L	M
2026	N	P	Q	R	S	T	U	V	W	X	Y	Z

Note

- Marking code repeats every four years in alphabetical order (letter of I, i, O, and o are excluded)



STANDARD RATINGS								
CAPACITANCE (μ F)	CASE CODE	PART NUMBER	MAX. DCL AT 25 °C (μ A)	MAX. DF AT 25 °C 120 Hz (%)	MAX. ESR AT + 25 °C 100 kHz (m Ω)	MAX. RIPPLE AT 45 °C 100 kHz I _{RMS} (A)	MAX. OPERATING TEMPERATURE (°C)	HIGH TEMPERATURE LOAD, TIME (h)
2.5 V _{DC}								
22	A	T55A226M2R5C0200	5.5	10	200	0.75	105	1000
22	A	T55A226M2R5C0180	5.5	10	180	0.79	105	1000
33	A	T55A336M2R5C0200	8.2	10	200	0.75	105	1000
33	A	T55A336M2R5C0180	8.2	10	180	0.79	105	1000
47	A	T55A476M2R5C0200	11.7	10	200	0.75	105	1000
47	A	T55A476M2R5C0180	11.7	10	180	0.79	105	1000
68	A	T55A686M2R5C0250	17.0	10	250	0.67	105	1000
68	A	T55A686M2R5C0200	17.0	10	200	0.75	105	1000
68	B	T55B686M2R5C0070	17.0	8	70	1.36	125	2000
100	A	T55A107M2R5C0200	25.0	10	200	0.75	105	1000
100	A	T55A107M2R5C0100	25.0	10	100	1.07	105	1000
100	T	T55T107M2R5C0070	25.0	10	70	1.22	105	1000
100	B	T55B107M2R5C0070	25.0	8	70	1.36	125	2000
100	B	T55B107M2R5C0055	25.0	8	55	1.53	125	2000
150	B	T55B157M2R5C0070	37.5	8	70	1.36	105	2000
150	B	T55B157M2R5C0055	37.5	8	55	1.53	105	2000
220	B	T55B227M2R5C0070	55.0	8	70	1.36	105	2000
220	B	T55B227M2R5C0055	55.0	8	55	1.53	105	2000
220	B	T55B227M2R5C0045	55.0	8	45	1.69	105	2000
220	B	T55B227M2R5C0035	55.0	8	35	1.93	105	2000
220	B	T55B227M2R5C0030	55.0	8	30	2.08	105	2000
220	B	T55B227M2R5C0025	55.0	8	25	2.28	105	2000
220	V	T55V227M2R5C0025	55.0	10	25	2.73	125	2000
220	V	T55V227M2R5C0018	55.0	10	18	3.22	125	2000
220	V	T55V227M2R5C0015	55.0	10	15	3.53	125	2000
330	B	T55B337M2R5C0070	82.5	8	70	1.36	105	2000
330	B	T55B337M2R5C0045	82.5	8	45	1.70	105	2000
330	B	T55B337M2R5C0035	82.5	8	35	1.93	105	2000
330	B	T55B337M2R5C0025	82.5	8	25	2.28	105	2000
330	Z	T55Z337M2R5C0025	82.5	10	25	2.73	105	2000
330	Z	T55Z337M2R5C0018	82.5	10	18	3.22	105	2000
330	V	T55V337M2R5C0040	82.5	10	40	2.16	125	2000
330	V	T55V337M2R5C0025	82.5	10	25	2.73	125	2000
330	V	T55V337M2R5C0018	82.5	10	18	3.22	125	2000
330	V	T55V337M2R5C0015	82.5	10	15	3.53	125	2000
330	D	T55D337M2R5C0009	82.5	10	9	5.00	125	2000
330	D	T55D337M2R5C0008	82.5	10	8	5.30	125	2000
330	D	T55D337M2R5C0007	82.5	10	7	5.66	125	2000
470	B	T55B477M2R5C0025	117.5	8	25	2.28	105	2000
470	Z	T55Z477M2R5C0025	117.5	10	25	2.73	105	2000
470	V	T55V477M2R5C0025	117.5	10	25	2.73	105	2000
470	V	T55V477M2R5C0012	117.5	10	12	3.94	105	2000
470	D	T55D477M2R5C0050	117.5	10	50	2.12	125	2000
470	D	T55D477M2R5C0040	117.5	10	40	2.37	125	2000
470	D	T55D477M2R5C0025	117.5	10	25	3.00	125	2000
470	D	T55D477M2R5C0015	117.5	10	15	3.87	125	2000
470	D	T55D477M2R5C0012	117.5	10	12	4.33	125	2000
470	D	T55D477M2R5C0009	117.5	10	9	5.00	125	2000
470	D	T55D477M2R5C0008	117.5	10	8	5.30	125	2000
470	D	T55D477M2R5C0007	117.5	10	7	5.66	125	2000
680	D	T55D687M2R5C0009	170.0	10	9	5.00	125	2000
680	D	T55D687M2R5C0008	170.0	10	8	5.30	125	2000
680	D	T55D687M2R5C0007	170.0	10	7	5.66	125	2000
1000	D	T55D108M2R5C0009	250.0	10	9	5.00	105	2000
1000	D	T55D108M2R5C0008	250.0	10	8	5.30	105	2000
1000	D	T55D108M2R5C0007	250.0	10	7	5.67	105	2000
1000	D	T55D108M2R5C0006	250.0	10	6	6.12	105	1000

Notes

- Termination code "C": cases C, J, P: 100 % tin, case A, T, B, Z, V, D: Ni / Pd / Au
- (1) High temperature load time is 2000h at +105 °C



STANDARD RATINGS								
CAPACITANCE (μ F)	CASE CODE	PART NUMBER	MAX. DCL AT 25 °C (μ A)	MAX. DF AT 25 °C 120 Hz (%)	MAX. ESR AT + 25 °C 100 kHz (m Ω)	MAX. RIPPLE AT 45 °C 100 kHz I _{RMS} (A)	MAX. OPERATING TEMPERATURE (°C)	HIGH TEMPERATURE LOAD, TIME (h)
4 V _{DC}								
10	J	T55J106M004C0500	10.0	10	500	0.32	105	1000
10	P	T55P106M004C0500	5.0	10	500	0.36	105	1000
10	P	T55P106M004C0300	5.0	10	300	0.46	105	1000
10	P	T55P106M004C0200	5.0	10	200	0.56	105	1000
10	A	T55A106M004C0500	4.0	10	500	0.48	105	1000
10	A	T55A106M004C0200	4.0	10	200	0.76	105	1000
15	P	T55P156M004C0500	10.0	10	500	0.36	105	1000
15	P	T55P156M004C0200	10.0	10	200	0.56	105	1000
15	A	T55A156M004C0500	6.0	10	500	0.48	105	1000
15	A	T55A156M004C0300	6.0	10	300	0.61	105	1000
15	A	T55A156M004C0200	6.0	10	200	0.76	105	1000
22	A	T55A226M004C0500	8.8	10	500	0.48	105	1000
22	A	T55A226M004C0300	8.8	10	300	0.61	105	1000
22	A	T55A226M004C0200	8.8	10	200	0.76	105	1000
22	B	T55B226M004C0200	8.8	8	200	0.81	125	2000
22	B	T55B226M004C0150	8.8	8	150	0.93	125	2000
33	A	T55A336M004C0500	13.2	10	500	0.48	105	1000
33	A	T55A336M004C0300	13.2	10	300	0.61	105	1000
33	A	T55A336M004C0200	13.2	10	200	0.76	105	1000
33	B	T55B336M004C0200	13.2	8	200	0.81	125	2000
47	A	T55A476M004C0500	18.8	10	500	0.48	105	1000
47	A	T55A476M004C0200	18.8	10	200	0.76	105	1000
47	A	T55A476M004C0180	18.8	10	180	0.79	105	1000
47	T	T55T476M004C0200	18.8	10	200	0.72	105	1000
47	T	T55T476M004C0080	18.8	10	80	1.15	105	1000
47	T	T55T476M004C0070	18.8	10	70	1.22	105	1000
47	B	T55B476M004C0150	18.8	8	150	0.93	125	2000
47	B	T55B476M004C0070	18.8	8	70	1.36	125	2000
68	A	T55A686M004C0500	27.2	10	500	0.48	105	1000
68	A	T55A686M004C0250	27.2	10	250	0.67	105	1000
68	A	T55A686M004C0200	27.2	10	200	0.76	105	1000
68	T	T55T686M004C0200	27.2	10	200	0.72	105	1000
68	T	T55T686M004C0180	27.2	10	180	0.76	105	1000
68	T	T55T686M004C0080	27.2	10	80	1.15	105	1000
68	T	T55T686M004C0070	27.2	10	70	1.22	105	1000
68	B	T55B686M004C0150	27.2	8	150	0.93	125	2000
68	B	T55B686M004C0070	27.2	8	70	1.36	125	2000
100	A	T55A107M004C0200	40.0	10	200	0.75	105	1000
100	A	T55A107M004C0100	40.0	10	100	1.07	105	1000
100	T	T55T107M004C0150	40.0	10	150	0.84	105	1000
100	T	T55T107M004C0070	40.0	10	70	1.22	105	1000
100	B	T55B107M004C0070	40.0	8	70	1.36	125	2000
100	B	T55B107M004C0055	40.0	8	55	1.53	125	2000
100	B	T55B107M004C0045	40.0	8	45	1.70	125	2000
100	B	T55B107M004C0040	40.0	8	40	1.80	125	2000
100	B	T55B107M004C0035	40.0	8	35	1.92	125	2000
150	B	T55B157M004C0070	60.0	8	70	1.36	105	2000
150	B	T55B157M004C0055	60.0	8	55	1.53	105	2000
150	B	T55B157M004C0045	60.0	8	45	1.69	105	2000
150	B	T55B157M004C0040	60.0	8	40	1.80	105	2000
150	B	T55B157M004C0035	60.0	8	35	1.93	105	2000
150	Z	T55Z157M004C0025	60.0	10	25	2.73	105	2000
150	V	T55V157M004C0045	60.0	10	45	2.03	125	2000
150	V	T55V157M004C0025	60.0	10	25	2.73	125	2000
150	V	T55V157M004C0015	60.0	10	15	3.53	125	2000

Notes

- Termination code "C": cases C, J, P: 100 % tin, case A, T, B, Z, V, D: Ni / Pd / Au
- (1) High temperature load time is 2000h at +105 °C



STANDARD RATINGS								
CAPACITANCE (μ F)	CASE CODE	PART NUMBER	MAX. DCL AT 25 °C (μ A)	MAX. DF AT 25 °C 120 Hz (%)	MAX. ESR AT + 25 °C 100 kHz (m Ω)	MAX. RIPPLE AT 45 °C 100 kHz I _{RMS} (A)	MAX. OPERATING TEMPERATURE (°C)	HIGH TEMPERATURE LOAD, TIME (h)
4 V _{DC}								
220	B	T55B227M004C0070	88.0	8	70	1.36	105	2000
220	B	T55B227M004C0060	88.0	8	60	1.47	105	2000
220	B	T55B227M004C0055	88.0	8	55	1.53	105	2000
220	B	T55B227M004C0045	88.0	8	45	1.70	105	2000
220	B	T55B227M004C0035	88.0	8	35	1.93	105	2000
220	Z	T55Z227M004C0025	88.0	10	25	2.73	105	2000
220	Z	T55Z227M004C0018	88.0	10	18	3.22	105	2000
220	V	T55V227M004C0055	88.0	10	55	1.84	125	2000
220	V	T55V227M004C0045	88.0	10	45	2.03	125	2000
220	V	T55V227M004C0040	88.0	10	40	2.16	125	2000
220	V	T55V227M004C0035	88.0	10	35	2.31	125	2000
220	V	T55V227M004C0025	88.0	10	25	2.73	125	2000
220	V	T55V227M004C0018	88.0	10	18	3.22	125	2000
220	V	T55V227M004C0015	88.0	10	15	3.53	125	2000
220	D	T55D227M004C0055	88.0	10	55	2.02	125	2000
220	D	T55D227M004C0040	88.0	10	40	2.37	125	2000
220	D	T55D227M004C0025	88.0	10	25	3.00	125	2000
330	Z	T55Z337M004C0025	132.0	10	25	2.73	105	2000
330	Z	T55Z337M004C0018	132.0	10	18	3.22	105	2000
330	V	T55V337M004C0050	132.0	10	50	1.93	105	2000
330	V	T55V337M004C0045	132.0	10	45	2.03	105	2000
330	V	T55V337M004C0040	132.0	10	40	2.16	105	2000
330	V	T55V337M004C0025	132.0	10	25	2.73	105	2000
330	V	T55V337M004C0018	132.0	10	18	3.22	105	2000
330	V	T55V337M004C0015	132.0	10	15	3.53	105	2000
330	D	T55D337M004C0050	132.0	10	50	2.12	125	2000
330	D	T55D337M004C0040	132.0	10	40	2.37	125	2000
330	D	T55D337M004C0025	132.0	10	25	3.00	125	2000
330	D	T55D337M004C0015	132.0	10	15	3.87	125	2000
330	D	T55D337M004C0009	132.0	10	9	5.00	125	2000
330	D	T55D337M004C0008	132.0	10	8	5.30	125	2000
330	D	T55D337M004C0007	132.0	10	7	5.66	125	2000
470	Z	T55Z477M004C0025	188.0	10	25	2.74	105	2000
470	Z	T55Z477M004C0018	188.0	10	18	3.22	105	2000
470	D	T55D477M004C0055	188.0	10	55	2.02	125	2000
470	D	T55D477M004C0050	188.0	10	50	2.12	125	2000
470	D	T55D477M004C0040	188.0	10	40	2.37	125	2000
470	D	T55D477M004C0025	188.0	10	25	3.00	125	2000
470	D	T55D477M004C0018	188.0	10	18	3.53	125	2000
470	D	T55D477M004C0015	188.0	10	15	3.87	125	2000
470	D	T55D477M004C0012	188.0	10	12	4.33	125	2000
470	D	T55D477M004C0009	188.0	10	9	5.00	125	2000
470	D	T55D477M004C0008	188.0	10	8	5.30	125	2000
470	D	T55D477M004C0007	188.0	10	7	5.66	125	2000
680	D	T55D687M004C0025	272.0	10	25	3.00	105	2000
680	D	T55D687M004C0018	272.0	10	18	3.53	105	2000
680	D	T55D687M004C0015	272.0	10	15	3.87	105	2000
680	D	T55D687M004C0009	272.0	10	9	5.00	105	2000
680	D	T55D687M004C0008	272.0	10	8	5.30	105	2000
680	D	T55D687M004C0007	272.0	10	7	5.66	105	2000
680	D	T55D687M004C0006	272.0	10	6	6.12	105	1000

Notes

- Termination code "C": cases C, J, P: 100 % tin, case A, T, B, Z, V, D: Ni / Pd / Au
- (1) High temperature load time is 2000h at +105 °C



STANDARD RATINGS									
CAPACITANCE (μ F)	CASE CODE	PART NUMBER	MAX. DCL AT 25 °C (μ A)	MAX. DF AT 25 °C 120 Hz (%)	MAX. ESR AT + 25 °C 100 kHz (m Ω)	MAX. RIPPLE AT 45 °C 100 kHz I _{RMS} (A)	MAX. OPERATING TEMPERATURE (°C)	HIGH TEMPERATURE LOAD, TIME (h)	
6.3 V _{DC}									
3.3	J	T55J335M6R3C0500	10.0	10	500	0.32	105	1000	
3.3	P	T55P335M6R3C0500	5.0	10	500	0.36	105	1000	
4.7	J	T55J475M6R3C0500	10.0	10	500	0.32	105	1000	
4.7	P	T55P475M6R3C0500	5.0	10	500	0.36	105	1000	
4.7	A	T55A475M6R3C0500	3.0	10	500	0.48	105	1000	
6.8	P	T55P685M6R3C0500	5.0	10	500	0.36	105	1000	
6.8	A	T55A685M6R3C0500	4.2	10	500	0.48	105	1000	
10	P	T55P106M6R3C0500	10.0	10	500	0.36	105	1000	
10	P	T55P106M6R3C0200	10.0	10	200	0.56	105	1000	
10	A	T55A106M6R3C0500	6.3	10	500	0.48	105	1000	
10	A	T55A106M6R3C0300	6.3	10	300	0.61	105	1000	
10	A	T55A106M6R3C0200	6.3	10	200	0.76	105	1000	
15	A	T55A156M6R3C0500	9.4	10	500	0.48	105	1000	
15	A	T55A156M6R3C0300	9.4	10	300	0.61	105	1000	
15	A	T55A156M6R3C0200	9.4	10	200	0.76	105	1000	
22	A	T55A226M6R3C0500	13.8	10	500	0.48	105	1000	
22	A	T55A226M6R3C0300	13.8	10	300	0.61	105	1000	
22	A	T55A226M6R3C0200	13.8	10	200	0.76	105	2000	
22	T	T55T226M6R3C0150	13.8	10	150	0.84	105	1000	
22	T	T55T226M6R3C0070	13.8	10	70	1.22	105	1000	
22	B	T55B226M6R3C0150	13.8	8	150	0.93	125	2000	
33	A	T55A336M6R3C0500	20.7	10	500	0.48	105	1000	
33	A	T55A336M6R3C0200	20.7	10	200	0.76	105	1000	
33	A	T55A336M6R3C0180	20.7	10	180	0.79	105	1000	
33	T	T55T336M6R3C0200	20.7	10	200	0.72	105	1000	
33	T	T55T336M6R3C0150	20.7	10	150	0.84	105	1000	
33	T	T55T336M6R3C0070	20.7	10	70	1.22	105	1000	
33	B	T55B336M6R3C0200	20.7	8	200	0.81	125	2000	
33	B	T55B336M6R3C0150	20.7	8	150	0.93	125	2000	
33	B	T55B336M6R3C0080	20.7	8	80	1.27	125	2000	
33	B	T55B336M6R3C0070	20.7	8	70	1.36	125	2000	
33	B	T55B336M6R3C0040	20.7	8	40	1.80	125	2000	
47	A	T55A476M6R3C0500	29.6	10	500	0.48	105	1000	
47	A	T55A476M6R3C0200	29.6	10	200	0.76	105	1000	
47	A	T55A476M6R3C0180	29.6	10	180	0.79	105	1000	
47	A	T55A476M6R3C0150	29.6	10	150	0.88	105	1000	
47	A	T55A476M6R3C0100	29.6	10	100	1.07	105	1000	
47	A	T55A476M6R3C0070	29.6	10	70	1.28	105	1000	
47	T	T55T476M6R3C0200	29.6	10	200	0.72	105	1000	
47	T	T55T476M6R3C0120	29.6	10	120	0.93	105	1000	
47	T	T55T476M6R3C0080	29.6	10	80	1.15	105	1000	
47	T	T55T476M6R3C0070	29.6	10	70	1.22	105	1000	
47	T	T55T476M6R3C0050	29.6	10	50	1.44	105	1000	
47	B	T55B476M6R3C0150	29.6	8	150	0.93	125	2000	
47	B	T55B476M6R3C0070	29.6	8	70	1.36	125	2000	
47	B	T55B476M6R3C0060	29.6	8	60	1.47	125	2000	
47	B	T55B476M6R3C0040	29.6	8	40	1.80	125	2000	
68	T	T55T686M6R3C0200	42.8	10	200	0.72	105	1000	
68	T	T55T686M6R3C0150	42.8	10	150	0.83	105	1000	
68	T	T55T686M6R3C0070	42.8	10	70	1.22	105	1000	
68	B	T55B686M6R3C0150	42.8	8	150	0.93	105	2000	
68	B	T55B686M6R3C0070	42.8	8	70	1.36	105	2000	
100	A	T55A107M6R3C0200	63.0	10	200	0.76	105	1000	
100	A	T55A107M6R3C0150	63.0	10	150	0.88	105	1000	
100	A	T55A107M6R3C0100	63.0	10	100	1.07	105	1000	
100	A	T55A107M6R3C0070	63.0	10	70	1.28	105	1000	
100	A	T55A107M6R3C0045	63.0	10	45	1.59	105	1000	

Notes

- Termination code "C": cases C, J, P: 100 % tin, case A, T, B, Z, V, D: Ni / Pd / Au
- (1) High temperature load time is 2000h at +105 °C



STANDARD RATINGS									
CAPACITANCE (μ F)	CASE CODE	PART NUMBER	MAX. DCL AT 25 °C (μ A)	MAX. DF AT 25 °C 120 Hz (%)	MAX. ESR AT + 25 °C 100 kHz (m Ω)	MAX. RIPPLE AT 45 °C 100 kHz I _{RMS} (A)	MAX. OPERATING TEMPERATURE (°C)	HIGH TEMPERATURE LOAD, TIME (h)	
6.3 V _{DC}									
100	T	T55T107M6R3C0200	63.0	10	200	0.72	105	1000	
100	T	T55T107M6R3C0070	63.0	10	70	1.22	105	2000	
100	B	T55B107M6R3C0100	63.0	8	100	1.14	105	2000	
100	B	T55B107M6R3C0070	63.0	8	70	1.36	105	2000	
100	B	T55B107M6R3C0055	63.0	8	55	1.53	105	2000	
100	B	T55B107M6R3C0045	63.0	8	45	1.70	105	2000	
100	B	T55B107M6R3C0040	63.0	8	40	1.80	105	2000	
100	B	T55B107M6R3C0035	63.0	8	35	1.93	105	2000	
100	Z	T55Z107M6R3C0045	63.0	10	45	2.03	105	2000	
100	V	T55V107M6R3C0045	63.0	10	45	2.03	125	2000	
100	D	T55D107M6R3C0015	63.0	10	15	3.87	125	2000	
150	B	T55B157M6R3C0100	94.5	8	100	1.14	105	2000	
150	B	T55B157M6R3C0070	94.5	8	70	1.36	105	2000	
150	B	T55B157M6R3C0055	94.5	8	55	1.53	105	2000	
150	B	T55B157M6R3C0045	94.5	8	45	1.70	105	2000	
150	B	T55B157M6R3C0040	94.5	8	40	1.80	105	2000	
150	B	T55B157M6R3C0035	94.5	8	35	1.93	105	2000	
150	B	T55B157M6R3C0025	94.5	8	25	2.28	105	2000	
150	Z	T55Z157M6R3C0035	94.5	10	35	2.31	105	2000	
150	Z	T55Z157M6R3C0025	94.5	10	25	2.73	105	2000	
150	Z	T55Z157M6R3C0018	94.5	10	18	3.22	105	2000	
150	V	T55V157M6R3C0055	94.5	10	55	1.84	125	2000	
150	V	T55V157M6R3C0045	94.5	10	45	2.03	125	2000	
150	V	T55V157M6R3C0040	94.5	10	40	2.16	125	2000	
150	V	T55V157M6R3C0035	94.5	10	35	2.31	125	2000	
150	V	T55V157M6R3C0025	94.5	10	25	2.73	125	2000	
150	V	T55V157M6R3C0018	94.5	10	18	3.22	125	2000	
150	D	T55D157M6R3C0025	94.5	10	25	3.00	125	2000	
220	B	T55B227M6R3C0200	138.6	8	200	0.80	105	2000	
220	B	T55B227M6R3C0070	138.6	8	70	1.36	105	2000	
220	B	T55B227M6R3C0045	138.6	8	45	1.69	105	2000	
220	B	T55B227M6R3C0035	138.6	8	35	1.93	105	2000	
220	B	T55B227M6R3C0025	138.6	8	25	2.28	105	2000	
220	Z	T55Z227M6R3C0025	138.6	10	25	2.73	105	2000	
220	Z	T55Z227M6R3C0018	138.6	10	18	3.22	105	2000	
220	V	T55V227M6R3C0050	138.6	10	50	1.93	125	2000	
220	V	T55V227M6R3C0045	138.6	10	45	2.03	125	2000	
220	V	T55V227M6R3C0040	138.6	10	40	2.16	125	2000	
220	V	T55V227M6R3C0035	138.6	10	35	2.31	125	2000	
220	V	T55V227M6R3C0025	138.6	10	25	2.73	125	2000	
220	V	T55V227M6R3C0018	138.6	10	18	3.22	125	2000	
220	V	T55V227M6R3C0015	138.6	10	15	3.53	125	2000	
220	D	T55D227M6R3C0055	138.6	10	55	2.02	125	2000	
220	D	T55D227M6R3C0050	138.6	10	50	2.12	125	2000	
220	D	T55D227M6R3C0040	138.6	10	40	2.37	125	2000	
220	D	T55D227M6R3C0035	138.6	10	35	2.53	125	2000	
220	D	T55D227M6R3C0025	138.6	10	25	3.00	125	2000	
220	D	T55D227M6R3C0009	138.6	10	9	5.00	125	2000	
220	D	T55D227M6R3C0008	138.6	10	8	5.30	125	2000	
220	D	T55D227M6R3C0007	138.6	10	7	5.66	125	2000	
330	V	T55V337M6R3C0050	207.9	10	50	1.93	105	2000	
330	V	T55V337M6R3C0045	207.9	10	45	2.03	105	2000	
330	V	T55V337M6R3C0040	207.9	10	40	2.16	105	2000	
330	V	T55V337M6R3C0025	207.9	10	25	2.73	105	2000	
330	V	T55V337M6R3C0018	207.9	10	18	3.22	105	2000	
330	V	T55V337M6R3C0015	207.9	10	15	3.53	105	2000	

Notes

- Termination code "C": cases C, J, P: 100 % tin, case A, T, B, Z, V, D: Ni / Pd / Au
- (1) High temperature load time is 2000h at +105 °C



STANDARD RATINGS								
CAPACITANCE (μ F)	CASE CODE	PART NUMBER	MAX. DCL AT 25 °C (μ A)	MAX. DF AT 25 °C 120 Hz (%)	MAX. ESR AT + 25 °C 100 kHz (m Ω)	MAX. RIPPLE AT 45 °C 100 kHz I _{RMS} (A)	MAX. OPERATING TEMPERATURE (°C)	HIGH TEMPERATURE LOAD, TIME (h)
6.3 V_{DC}								
330	D	T55D337M6R3C0055	207.9	10	55	2.02	125	2000
330	D	T55D337M6R3C0050	207.9	10	50	2.12	125	2000
330	D	T55D337M6R3C0045	207.9	10	45	2.23	125	2000
330	D	T55D337M6R3C0040	207.9	10	40	2.37	125	2000
330	D	T55D337M6R3C0025	207.9	10	25	3.00	125	2000
330	D	T55D337M6R3C0018	207.9	10	18	3.53	125	2000
330	D	T55D337M6R3C0015	207.9	10	15	3.87	125	2000
330	D	T55D337M6R3C0012	207.9	10	12	4.33	125	2000
330	D	T55D337M6R3C0009	207.9	10	9	5.00	125	2000
330	D	T55D337M6R3C0008	207.9	10	8	5.30	125	2000
330	D	T55D337M6R3C0007	207.9	10	7	5.66	125	2000
470	V	T55V477M6R3C0055	296.1	10	55	1.84	105	2000
470	V	T55V477M6R3C0050	296.1	10	50	1.93	105	2000
470	D	T55D477M6R3C0030	296.1	10	30	2.73	105	2000
470	D	T55D477M6R3C0025	296.1	10	25	3.00	105	2000
470	D	T55D477M6R3C0018	296.1	10	18	3.53	105	2000
470	D	T55D477M6R3C0015	296.1	10	15	3.87	105	2000
470	D	T55D477M6R3C0009	296.1	10	9	5.00	105	2000
470	D	T55D477M6R3C0008	296.1	10	8	5.30	105	2000
470	D	T55D477M6R3C0007	296.1	10	7	5.66	105	2000
680	D	T55D687M6R3C0025	428.4	10	25	3.00	105	2000
7 V_{DC}								
100	A	T55A107M007C0070	70.0	10	70	1.28	105	1000
470	D	T55D477M007C0025	329.0	10	25	3.00	105	2000
10 V_{DC}								
3.3	J	T55J335M010C0500	10.0	10	500	0.32	105	1000
3.3	P	T55P335M010C0500	5.0	10	500	0.36	105	1000
4.7	P	T55P475M010C0500	10.0	10	500	0.36	105	1000
4.7	P	T55P475M010C0200	10.0	10	200	0.56	105	1000
4.7	A	T55A475M010C0500	4.7	10	500	0.48	105	1000
4.7	A	T55A475M010C0300	4.7	10	300	0.61	105	1000
4.7	A	T55A475M010C0200	4.7	10	200	0.76	105	1000
6.8	A	T55A685M010C0500	6.8	10	500	0.48	105	1000
6.8	A	T55A685M010C0300	6.8	10	300	0.61	105	1000
6.8	A	T55A685M010C0200	6.8	10	200	0.76	105	1000
10	P	T55P106M010C0200	30.0	10	200	0.56	105	2000
10	A	T55A106M010C0500	10.0	10	500	0.48	105	1000
10	A	T55A106M010C0300	10.0	10	300	0.61	105	1000
10	A	T55A106M010C0200	10.0	10	200	0.76	105	1000
15	A	T55A156M010C0500	15.0	10	500	0.48	105	1000
15	A	T55A156M010C0200	15.0	10	200	0.76	105	1000
22	A	T55A226M010C0500	22.0	10	500	0.48	105	1000
22	A	T55A226M010C0200	22.0	10	200	0.76	105	1000
22	A	T55A226M010C0080	22.0	10	80	1.19	105	1000
22	T	T55T226M010C0200	22.0	10	200	0.72	105	1000
22	T	T55T226M010C0150	22.0	10	150	0.84	105	1000
22	T	T55T226M010C0070	22.0	10	70	1.22	105	1000
22	B	T55B226M010C0300	22.0	8	300	0.66	125	1000
22	B	T55B226M010C0200	22.0	8	200	0.81	125	1000
22	B	T55B226M010C0150	22.0	8	150	0.93	125	1000
22	B	T55B226M010C0070	22.0	8	70	1.36	125	1000
33	A	T55A336M010C0500	33.0	10	500	0.48	105	1000
33	A	T55A336M010C0200	33.0	10	200	0.76	105	1000
33	A	T55A336M010C0150	33.0	10	150	0.88	105	1000
33	A	T55A336M010C0070	33.0	10	70	1.28	105	1000

Notes

- Termination code "C": cases C, J, P: 100 % tin, case A, T, B, Z, V, D: Ni / Pd / Au

(1) High temperature load time is 2000h at +105 °C



STANDARD RATINGS								
CAPACITANCE (μ F)	CASE CODE	PART NUMBER	MAX. DCL AT 25 °C (μ A)	MAX. DF AT 25 °C 120 Hz (%)	MAX. ESR AT + 25 °C 100 kHz (m Ω)	MAX. RIPPLE AT 45 °C 100 kHz I _{RMS} (A)	MAX. OPERATING TEMPERATURE (°C)	HIGH TEMPERATURE LOAD, TIME (h)
10 V_{DC}								
33	T	T55T336M010C0200	33.0	10	200	0.72	105	1000
33	T	T55T336M010C0150	33.0	10	150	0.84	105	1000
33	T	T55T336M010C0080	33.0	10	80	1.14	105	1000
33	T	T55T336M010C0070	33.0	10	70	1.22	105	1000
33	T	T55T336M010C0040	33.0	8	40	1.62	105	2000
33	B	T55B336M010C0200	33.0	8	200	0.81	125	1000
33	B	T55B336M010C0150	33.0	8	150	0.93	125	1000
33	B	T55B336M010C0080	33.0	8	80	1.27	125	1000
33	B	T55B336M010C0070	33.0	8	70	1.36	125	1000
47	B	T55B476M010C0150	47.0	8	150	0.93	105	1000
47	B	T55B476M010C0070	47.0	8	70	1.36	105	1000
68	V	T55V686M010C0100	68.0	10	100	1.36	125	2000
68	V	T55V686M010C0060	68.0	10	60	1.76	125	2000
100	Z	T55Z107M010C0045	100.0	10	45	2.03	105	2000
100	Z	T55Z107M010C0025	100.0	10	25	2.73	105	2000
100	V	T55V107M010C0045	100.0	10	45	2.03	125	2000
100	D	T55D107M010C0080	100.0	10	80	1.67	125	2000
100	D	T55D107M010C0055	100.0	10	55	2.02	125	2000
100	D	T55D107M010C0045	100.0	10	45	2.23	125	2000
100	D	T55D107M010C0040	100.0	10	40	2.37	125	2000
100	D	T55D107M010C0025	100.0	10	25	3.00	125	2000
100	D	T55D107M010C0018	100.0	10	18	3.53	125	2000
150	Z	T55Z157M010C0040	150.0	10	40	2.16	105	2000
150	Z	T55Z157M010C0025	150.0	10	25	2.73	105	2000
150	V	T55V157M010C0055	150.0	10	55	1.84	125	2000
150	V	T55V157M010C0045	150.0	10	45	2.03	125	2000
150	V	T55V157M010C0040	150.0	10	40	2.16	125	2000
150	V	T55V157M010C0025	150.0	10	25	2.73	125	2000
150	V	T55V157M010C0015	150.0	10	15	3.53	125	2000
150	D	T55D157M010C0040	150.0	10	40	2.37	125	2000
150	D	T55D157M010C0025	150.0	10	25	3.00	125	2000
150	D	T55D157M010C0015	150.0	10	15	3.87	125	2000
220	Z	T55Z227M010C0040	220.0	10	40	2.16	105	2000
220	Z	T55Z227M010C0025	220.0	10	25	2.73	105	2000
220	V	T55V227M010C0050	220.0	10	50	1.93	105	2000
220	V	T55V227M010C0045	220.0	10	45	2.03	105	2000
220	V	T55V227M010C0040	220.0	10	40	2.16	105	2000
220	V	T55V227M010C0025	220.0	10	25	2.73	105	2000
220	V	T55V227M010C0018	220.0	10	18	3.22	105	2000
220	D	T55D227M010C0055	220.0	10	55	2.02	125	2000
220	D	T55D227M010C0050	220.0	10	50	2.12	125	2000
220	D	T55D227M010C0040	220.0	10	40	2.37	125	2000
220	D	T55D227M010C0025	220.0	10	25	3.00	125	2000
220	D	T55D227M010C0018	220.0	10	18	3.53	125	2000
220	D	T55D227M010C0009	220.0	10	9	5.00	125	2000
220	D	T55D227M010C0008	220.0	10	8	5.30	125	2000
220	D	T55D227M010C0007	220.0	10	7	5.66	125	2000
330	D	T55D337M010C0040	330.0	10	40	2.37	105	2000
330	D	T55D337M010C0035	330.0	10	35	2.53	105	2000
330	D	T55D337M010C0025	330.0	10	25	3.00	105	2000
330	D	T55D337M010C0018	330.0	10	18	3.53	105	2000
330	D	T55D337M010C0009	330.0	10	9	5.00	125	2000
330	D	T55D337M010C0008	330.0	10	8	5.30	125	2000
330	D	T55D337M010C0007	330.0	10	7	5.66	125	2000
12.5 V_{DC}								
15	T	T55T156M12RC0080	18.7	8	80	1.14	105	1000

Notes

- Termination code "C": cases C, J, P: 100 % tin, case A, T, B, Z, V, D: Ni / Pd / Au

(1) High temperature load time is 2000h at +105 °C



STANDARD RATINGS								
CAPACITANCE (μ F)	CASE CODE	PART NUMBER	MAX. DCL AT 25 °C (μ A)	MAX. DF AT 25 °C 120 Hz (%)	MAX. ESR AT + 25 °C 100 kHz (m Ω)	MAX. RIPPLE AT 45 °C 100 kHz I _{RMS} (A)	MAX. OPERATING TEMPERATURE (°C)	HIGH TEMPERATURE LOAD, TIME (h)
16 V_{DC}								
6.8	B	T55B685M016C0200	10.8	8	200	0.80	125	2000
10	B	T55B106M016C0200	16.0	8	200	0.80	125	2000
10	B	T55B106M016C0100	16.0	8	100	1.14	125	2000
15	B	T55B156M016C0150	24.0	8	150	0.93	125	2000
15	B	T55B156M016C0090	24.0	8	90	1.20	125	2000
22	B	T55B226M016C0150	35.2	8	150	0.93	125	2000
22	B	T55B226M016C0070	35.2	8	70	1.36	125	2000
33	B	T55B336M016C0070	52.8	8	70	1.36	105	2000
33	V	T55V336M016C0070	52.8	10	70	1.63	125	2000
33	D	T55D336M016C0070	52.8	10	70	1.79	125	2000
47	Z	T55Z476M016C0045	75.2	10	45	2.03	105	2000
47	V	T55V476M016C0070	75.2	10	70	1.63	125	2000
47	V	T55V476M016C0045	75.2	10	45	2.03	125	2000
47	D	T55D476M016C0070	75.2	10	70	1.79	125	2000
47	D	T55D476M016C0065	75.2	10	65	1.86	125	2000
47	D	T55D476M016C0035	75.2	10	35	2.53	125	2000
68	V	T55V686M016C0070	108.8	10	70	1.63	125	2000
68	V	T55V686M016C0050	108.8	10	50	1.934	125	2000
100	Z	T55Z107M016C0050	160.0	10	50	1.93	105	2000
100	V	T55V107M016C0050	160.0	10	50	1.93	125	2000
100	D	T55D107M016C0050	160.0	10	50	2.12	125	2000
150	D	T55D157M016C0050	240.0	10	50	2.12	105	2000
150	D	T55D157M016C0040	240.0	10	40	2.37	105	2000
150	D	T55D157M016C0015	240.0	10	15	3.87	125	2000
150	D	T55D157M016C0010	240.0	10	10	4.74	125	2000
20 V_{DC}								
15	B	T55B156M020C0090	30.0	8	90	1.20	125	2000
15	B	T55B156M020C0070	30.0	8	70	1.36	125	2000
15	V	T55V156M020C0125	30.0	10	125	1.22	125	2000
22	V	T55V226M020C0040	44.0	10	40	2.16	125	2000
33	V	T55V336M020C0040	66.0	10	40	2.16	125	2000
47	Z	T55Z476M020C0070	94.0	10	70	1.63	105	2000
47	V	T55V476M020C0045	94.0	10	45	2.03	125	2000
100	D	T55D107M020C0055	200.0	10	55	2.39	125	2000
25 V_{DC}								
6.8	B	T55B685M025C0100	17.0	8	100	1.14	125	2000
10	B	T55B106M025C0150	25.0	8	150	0.93	125	2000
10	B	T55B106M025C0100	25.0	8	100	1.14	125	2000
15	B	T55B156M025C0100	37.5	8	100	1.14	125 ⁽¹⁾	1000
15	V	T55V156M025C0125	37.5	10	125	1.22	125	2000
22	V	T55V226M025C0040	55.0	10	40	2.16	125	2000
33	Z	T55Z336M025C0050	82.5	10	50	1.93	105	2000
33	V	T55V336M025C0050	82.5	10	50	1.93	125	2000
33	V	T55V336M025C0040	82.5	10	40	2.16	125	2000
33	D	T55D336M025C0060	82.5	10	60	2.29	125	2000
47	D	T55D476M025C0065	117.5	10	65	2.20	125	2000
68	D	T55D686M025C0070	170.0	10	70	2.12	125	2000
100	D	T55D107M025C0060	250.0	10	60	2.29	125	2000
100	D	T55D107M025C0040	250.0	10	40	2.80	125	2000

Notes

- Termination code "C": cases C, J, P: 100 % tin, case A, T, B, Z, V, D: Ni / Pd / Au

⁽¹⁾ High temperature load time is 2000h at +105 °C



STANDARD RATINGS								
CAPACITANCE (μF)	CASE CODE	PART NUMBER	MAX. DCL AT 25 °C (μA)	MAX. DF AT 25 °C 120 Hz (%)	MAX. ESR AT + 25 °C 100 kHz (mΩ)	MAX. RIPPLE AT 45 °C 100 kHz I _{RMS} (A)	MAX. OPERATING TEMPERATURE (°C)	HIGH TEMPERATURE LOAD, TIME (h)
35 V_{DC}								
2.2	B	T55B225M035C0200	7.7	8	200	0.80	105	2000
4.7	B	T55B475M035C0200	16.4	8	200	0.80	105	2000
6.8	B	T55B685M035C0200	23.8	8	200	0.81	105	2000
10	B	T55B106M035C0200	35.0	8	200	0.80	105	2000
10	B	T55B106M035C0150	35.0	8	150	0.93	105	2000
10	D	T55D106M035C0120	35.0	10	120	1.62	125	2000
15	V	T55V156M035C0125	52.5	10	125	1.22	125	2000
22	Z	T55Z226M035C0070	77.0	10	70	1.63	105	2000
22	V	T55V226M035C0070	77.0	10	70	1.63	125	2000
22	D	T55D226M035C0120	77.0	10	120	1.62	125	2000
33	D	T55D336M035C0100	115.5	10	100	1.77	125	2000
33	D	T55D336M035C0065	115.5	10	65	2.20	125	2000
47	D	T55D476M035C0070	164.5	10	70	2.12	105	2000
47	D	T55D476M035C0055	164.5	10	55	2.39	105	2000
50 V_{DC}								
2.2	B	T55B225M050C0200	11.0	8	200	0.80	105	2000
10	D	T55D106M050C0120	50.0	10	120	1.62	125	2000
10	D	T55D106M050C0090	50.0	10	90	1.87	125	2000
15	D	T55D156M050C0090	75.0	10	90	1.87	105	2000
15	D	T55D156M050C0070	75.0	10	70	2.12	105	2000
63 V_{DC}								
1.0	B	T55B105M063C0200	6.3	8	200	0.80	105	2000
4.7	C	T55C475M063C0200	29.6	10	200	0.90	105	1000
4.7	D	T55D475M063C0100	29.6	10	100	1.77	125	2000
10	D	T55D106M063C0150	63.0	10	150	1.44	105	2000
10	D	T55D106M063C0060	63.0	10	60	2.29	105	2000

Notes

- Termination code "C": cases C, J, P: 100 % tin, case A, T, B, Z, V, D: Ni / Pd / Au
- (1) High temperature load time is 2000h at +105 °C

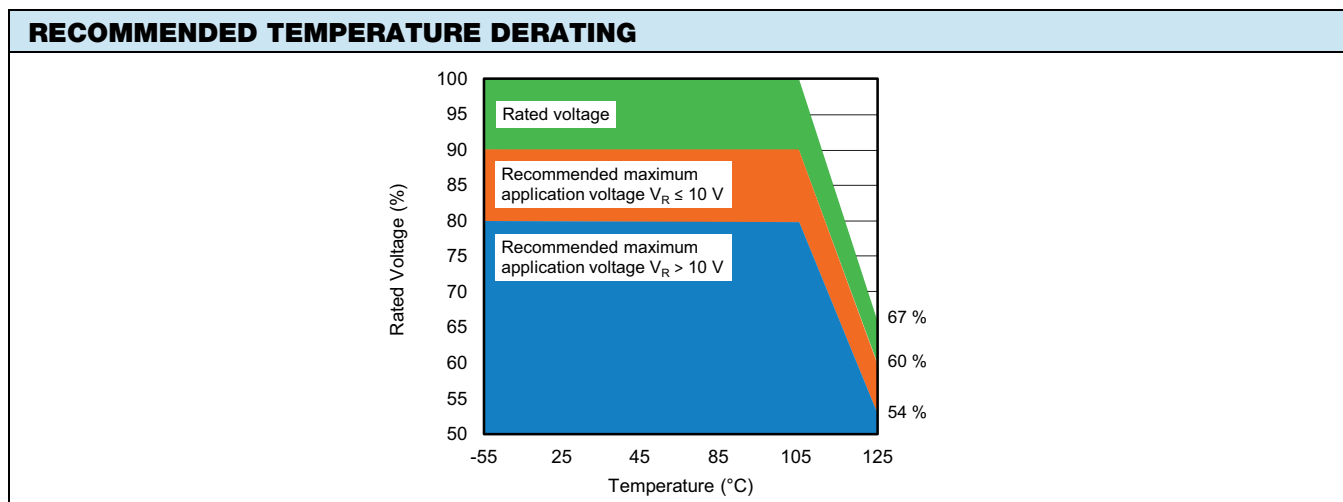

**RECOMMENDED VOLTAGE DERATING GUIDELINES**

CAPACITOR VOLTAGE RATING AT -55 °C TO +105 °C	CAPACITOR CATEGORY VOLTAGE ABOVE +105 °C TO +125 °C	RECOMMENDED VOLTAGE DERATING AT -55 °C TO +105 °C	RECOMMENDED VOLTAGE DERATING ABOVE +105 °C TO +125 °C
2.5	1.7	2.3	1.5
4	2.7	3.6	2.4
6.3	4.2	5.7	3.8
7	4.7	6.3	4.2
10	6.7	9	6.0
12.5	8.4	10	6.8
16	10.7	12.8	8.6
20	13.4	16	10.8
25	16.8	20	13.5
35	23.5	28	18.9
50	33.5	40	27.0
63	42.2	50	34

POWER DISSIPATION

CASE CODE	MAXIMUM PERMISSIBLE POWER DISSIPATION (W) AT $\leq +45$ °C IN FREE AIR
J	0.050
P	0.064
A	0.115
T	0.105
B	0.130
C	0.165
Z	0.187
V	0.187
D	0.225 (≤ 16 V), 0.315 (≥ 20 V)

STANDARD PACKAGING QUANTITY

CASE CODE	UNITS PER 7" REEL
J	4000
P	3000
A	2000
T	3000
B	2000
C	500
Z	800
V	800
D	500



PERFORMANCE CHARACTERISTICS																	
ITEM	CONDITION													POST TEST PERFORMANCE			
Temperature characteristics	Measure the specified characteristics in each stage													Specified initial value	-55 °C	+105 °C / +125 °C	
														Capacitance change	-	-30 % to 0 %	0 % to +50 %
														Dissipation factor shown in Standard Ratings table or less	8 to 10	14	-
														Leakage current	Refer to Standard Ratings table	-	Not more than 1 CV or 30 μ A which is greater
Surge voltage	105 °C, 1000 successive test cycles in series with a 1 k Ω resistor at the rate of 30 s ON, 30 s OFF; test voltage per table below:													Capacitance change	Within \pm 20 % of initial value		
	Rated voltage	2.5	4.0	6.3	7.0	10	12.5	16	20	25	35	50	63	Dissipation factor	Within initial limit		
	Surge voltage	3.2	5.2	8.2	9.0	13	16.2	20	23	29	40	57	72	Leakage current	Shall not exceed 300 % of initial limit		
Solder heat resistance	Reflow board surface peak temperature: less than 260 °C Time: 5 s max.													Capacitance change	Within \pm 20 % of initial value		
														Dissipation factor	Initial specified value or less		
														Leakage current	Shall not exceed 300 % of initial specified value		
Moisture resistance no load	Leave at 60 °C and 90 % RH for 500 h													Capacitance change	$V_R \leq 4$ V	Relative to the value before test +50 % to -20 %	
															$V_R \geq 6.3$ V	Relative to the value before test +40 % to -20 %	
														Dissipation factor	Initial specified value or less		
														Leakage current	Shall not exceed 300 % of initial specified value		
High temperature load	105 °C. The rated voltage is applied through a protective resistor of 3 Ω for 1000 h or 2000 h ⁽¹⁾ 125 °C. 2/3 rated voltage is applied through a protective resistor of 3 Ω for 1000 h or 2000 h ⁽¹⁾													Capacitance change	Within \pm 20 % of initial value		
														Dissipation factor	Initial specified value or less		
														Leakage current	Shall not exceed 300 % of initial specified value		
Thermal shock	Leave at -55 °C, normal temperature, 105 °C, and normal temperature for 30 min., 15 min. 30 min., and 15 min. Repeat this operation 5 times running.													Capacitance change	Within \pm 20 % of initial value or less		
														Dissipation factor	Initial specified value or less		
														Leakage current	Shall not exceed 300 % of initial specified value		
Failure rate	105 °C. The rated voltage is applied through a protective resistor of 1 Ω /V.													1 % / 1000 h			

Notes

- Test conditions per JIS C5101-1
- ⁽¹⁾ Test time and test temperature, please refer to table "Standard Ratings"



Guide for Tantalum Solid Electrolyte Chip Capacitors With Polymer Cathode

INTRODUCTION

Tantalum electrolytic capacitors are the preferred choice in applications where volumetric efficiency, stable electrical parameters, high reliability, and long service life are primary considerations. The stability and resistance to elevated temperatures of the tantalum/tantalum oxide/manganese dioxide system make solid tantalum capacitors an appropriate choice for today's surface mount assembly technology.

Vishay Sprague has been a pioneer and leader in this field, producing a large variety of tantalum capacitor types for consumer, industrial, automotive, military, and aerospace electronic applications.

Tantalum is not found in its pure state. Rather, it is commonly found in a number of oxide minerals, often in combination with Columbium ore. This combination is known as "tantalite" when its contents are more than one-half tantalum. Important sources of tantalite include Australia, Brazil, Canada, China, and several African countries. Synthetic tantalite concentrates produced from tin slags in Thailand, Malaysia, and Brazil are also a significant raw material for tantalum production.

Electronic applications, and particularly capacitors, consume the largest share of world tantalum production. Other important applications for tantalum include cutting tools (tantalum carbide), high temperature super alloys, chemical processing equipment, medical implants, and military ordnance.

Vishay Sprague is a major user of tantalum materials in the form of powder and wire for capacitor elements and rod and sheet for high temperature vacuum processing.

THE BASICS OF TANTALUM CAPACITORS

Most metals form crystalline oxides which are non-protecting, such as rust on iron or black oxide on copper. A few metals form dense, stable, tightly adhering, electrically insulating oxides. These are the so-called "valve"metals and include titanium, zirconium, niobium, tantalum, hafnium, and aluminum. Only a few of these permit the accurate control of oxide thickness by electrochemical means. Of these, the most valuable for the electronics industry are aluminum and tantalum.

Capacitors are basic to all kinds of electrical equipment, from radios and television sets to missile controls and automobile ignitions. Their function is to store an electrical charge for later use.

Capacitors consist of two conducting surfaces, usually metal plates, whose function is to conduct electricity. They are separated by an insulating material or dielectric. The dielectric used in all tantalum electrolytic capacitors is tantalum pentoxide.

Tantalum pentoxide compound possesses high-dielectric strength and a high-dielectric constant. As capacitors are being manufactured, a film of tantalum pentoxide is applied to their electrodes by means of an electrolytic process. The film is applied in various thicknesses and at various voltages and although transparent to begin with, it takes on different colors as light refracts through it. This coloring occurs on the tantalum electrodes of all types of tantalum capacitors.

Rating for rating, tantalum capacitors tend to have as much as three times better capacitance/volume efficiency than aluminum electrolytic capacitors. An approximation of the capacitance/volume efficiency of other types of capacitors may be inferred from the following table, which shows the dielectric constant ranges of the various materials used in each type. Note that tantalum pentoxide has a dielectric constant of 26, some three times greater than that of aluminum oxide. This, in addition to the fact that extremely thin films can be deposited during the electrolytic process mentioned earlier, makes the tantalum capacitor extremely efficient with respect to the number of microfarads available per unit volume. The capacitance of any capacitor is determined by the surface area of the two conducting plates, the distance between the plates, and the dielectric constant of the insulating material between the plates.

COMPARISON OF CAPACITOR DIELECTRIC CONSTANTS	
DIELECTRIC	ϵ DIELECTRIC CONSTANT
Air or vacuum	1.0
Paper	2.0 to 6.0
Plastic	2.1 to 6.0
Mineral oil	2.2 to 2.3
Silicone oil	2.7 to 2.8
Quartz	3.8 to 4.4
Glass	4.8 to 8.0
Porcelain	5.1 to 5.9
Mica	5.4 to 8.7
Aluminum oxide	8.4
Tantalum pentoxide	26
Ceramic	12 to 400K

In the tantalum electrolytic capacitor, the distance between the plates is very small since it is only the thickness of the tantalum pentoxide film. As the dielectric constant of the tantalum pentoxide is high, the capacitance of a tantalum capacitor is high if the area of the plates is large:

$$C = \frac{\epsilon A}{t}$$

where

C = capacitance

ϵ = dielectric constant

A = surface area of the dielectric

t = thickness of the dielectric

Tantalum capacitors contain either liquid or solid electrolytes. In solid electrolyte capacitors, a dry material (manganese dioxide) forms the cathode plate. A tantalum lead is embedded in or welded to the pellet, which is in turn connected to a termination or lead wire. The drawings show the construction details of the surface mount types of tantalum capacitors shown in this catalog.

SOLID ELECTROLYTE POLYMER TANTALUM CAPACITORS

Solid electrolyte polymer capacitors utilize sintered tantalum pellets as anodes. Tantalum pentoxide dielectric layer is formed on the entire surface of anode, which is further impregnated with highly conductive polymer as cathode system.

The conductive polymer layer is then coated with graphite, followed by a layer of metallic silver, which provides a conductive surface between the capacitor element and the outer termination (lead frame or other).

Molded chip polymer tantalum capacitor encases the element in plastic resins, such as epoxy materials. The molding compound has been selected to meet the requirements of UL 94 V-0 and outgassing requirements of ASTM E-595. After assembly, the capacitors are tested and inspected to assure long life and reliability. It offers excellent reliability and high stability for variety of applications in electronic devices. Usage of conductive polymer cathode system provides very low equivalent series resistance (ESR), which makes the capacitors particularly suitable for high frequency applications.

TANTALUM CAPACITOR WITH POLYMER CATHODE TYPE T50 / T51 / T55 / T56 / 04051

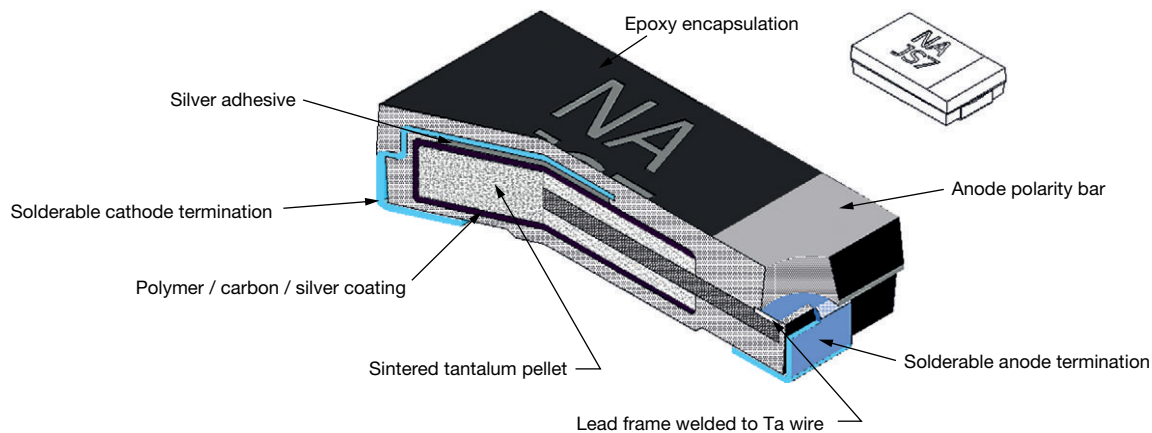

TANTALUM CAPACITOR WITH POLYMER CATHODE TYPE T58

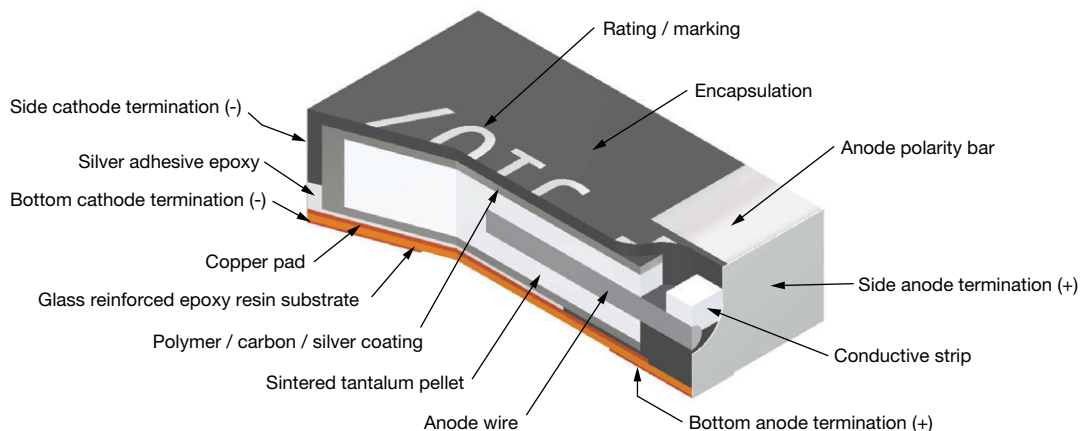

TANTALUM CAPACITOR WITH POLYMER CATHODE TYPE T52

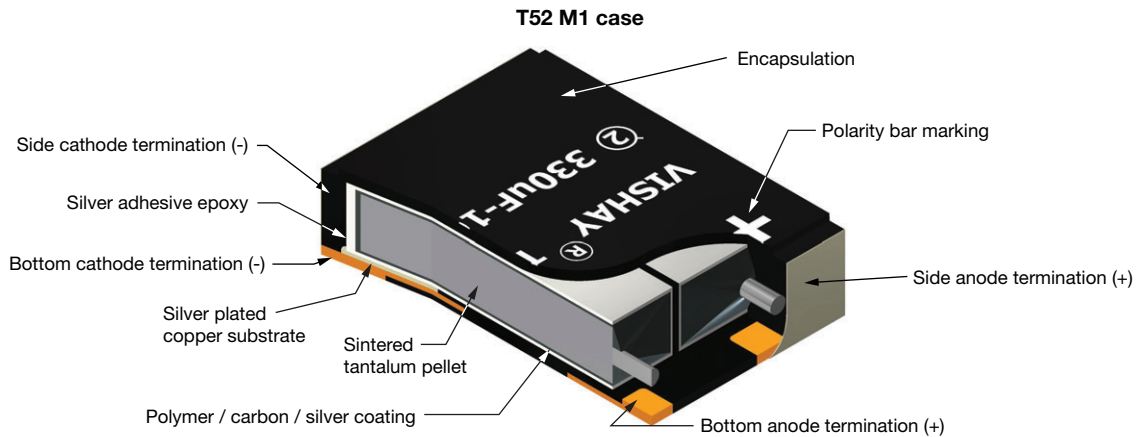
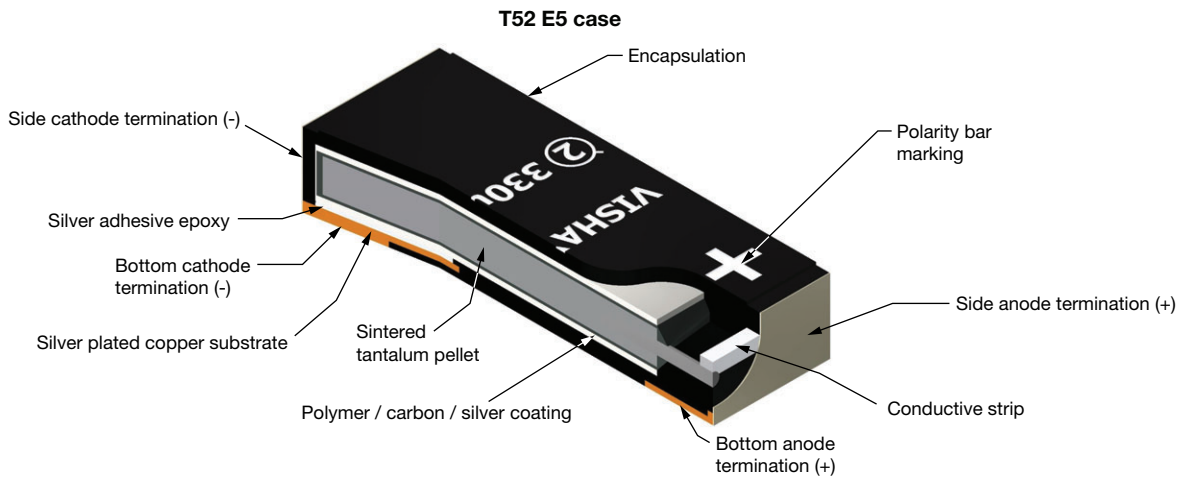

TANTALUM CAPACITOR WITH POLYMER CATHODE TYPE T54 / T59 / 20021

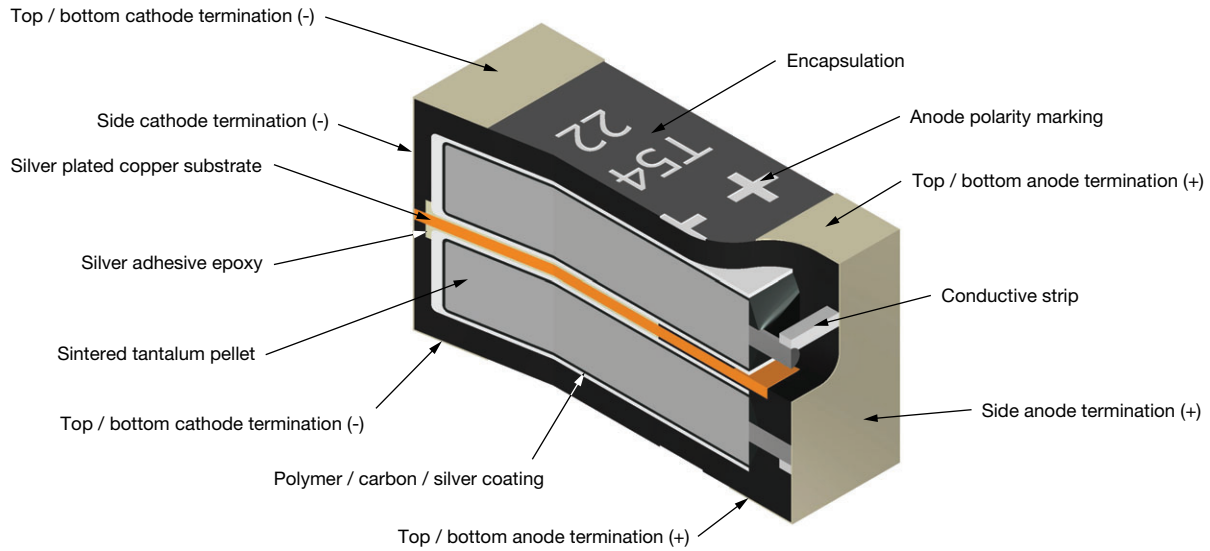

T54 EL case

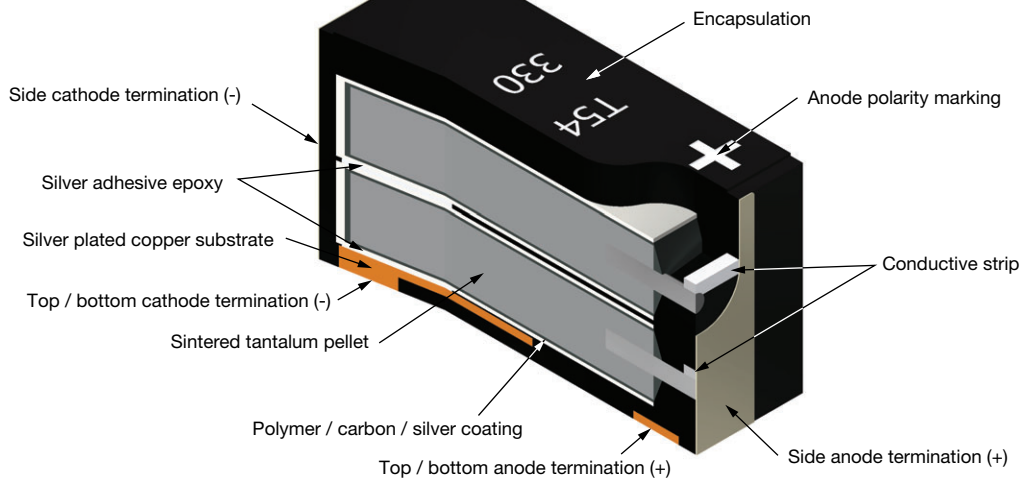

HERMETICALLY SEALED TANTALUM CAPACITOR WITH POLYMER CATHODE TYPE T27

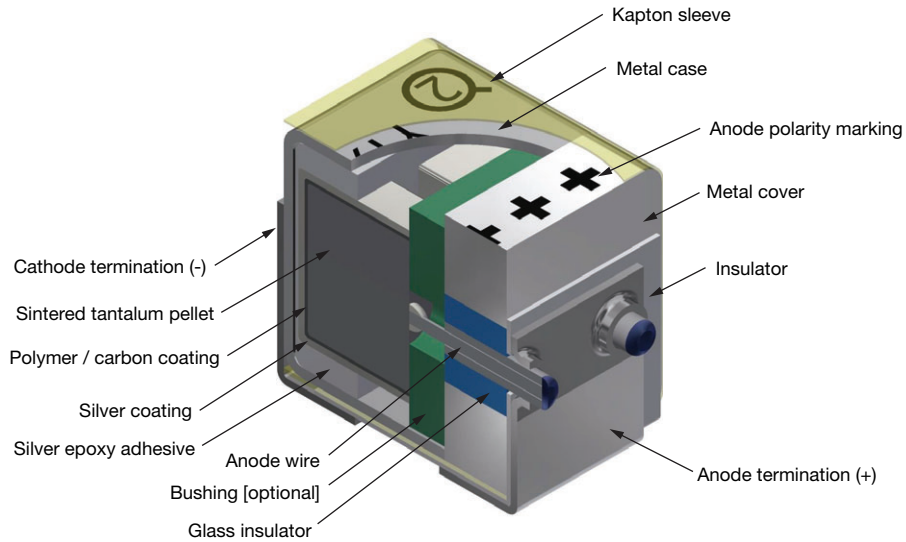

POLYMER CAPACITORS - METAL CASE, HERMETICALLY SEALED

SERIES	T27
PRODUCT IMAGE	
TYPE	VPolyTan™ hermetically sealed polymer surface-mount chip capacitors, low ESR
FEATURES	Hermetically sealed in metal case, low ESR / low DCL, hi-rel. processing
TEMPERATURE RANGE	-55 °C to +125 °C
CAPACITANCE RANGE	15 µF to 470 µF
VOLTAGE RANGE	16 V to 75 V
CAPACITANCE TOLERANCE	± 20 %
LEAKAGE CURRENT	0.05 CV
DISSIPATION FACTOR	12 %
ESR	25 mΩ to 100 mΩ
CASE SIZES	D
TERMINATION FINISH	100 % tin; tin / lead

POLYMER CAPACITORS - MOLDED CASE		
SERIES	T50, T51, T55, T56	04051
PRODUCT IMAGE		
TYPE	VPolyTan™, molded case, high performance polymer	VPolyTan™, molded case, high performance polymer
FEATURES	High performance	High performance
TEMPERATURE RANGE	-55 °C to +105 °C / +125 °C	-55 °C to +125 °C (above +105 °C, voltage derating is required)
CAPACITANCE RANGE	3.3 µF to 1000 µF	4.7 µF to 680 µF
VOLTAGE RANGE	2.5 V to 63 V	2.5 V to 63 V
CAPACITANCE TOLERANCE	± 20 %	± 10 %, ± 20 %
LEAKAGE CURRENT	0.1 CV	0.1 CV
DISSIPATION FACTOR	8 % to 10 %	8 % to 10 %
ESR	6 mΩ to 500 mΩ	25 mΩ to 125 mΩ
CASE SIZES	J, P, A, T, B, Z, V, D, C	B, D
TERMINATION FINISH	Cases J, P, C: 100 % tin Case A, T, B, Z, V, D: Ni / Pd / Au	All cases: tin / lead (SnPb)

POLYMER CAPACITORS - LEADFRAMELESS MOLDED CASE					
SERIES	T52	T58	T59	T54	20021
PRODUCT IMAGE					
TYPE	vPolyTan™ polymer surface mount chip capacitors, low profile, leadframeless molded type	vPolyTan™ polymer surface mount chip capacitors, compact, leadframeless molded type	vPolyTan™ polymer surface mount chip capacitors, low ESR, leadframeless molded type	vPolyTan™ polymer surface mount chip capacitors, low ESR, leadframeless molded type, hi-rel commercial off-the-shelf (COTS)	vPolyTan™ polymer surface mount chip capacitors, low ESR, leadframeless molded type, DLA approved
FEATURES	Low profile	Small case size	Multinode	Hi-rel COTS, multinode	Multinode
TEMPERATURE RANGE	-55 °C to +105 °C	-55 °C to +105 °C	-55 °C to +125 °C	-55 °C to +125 °C	-55 °C to +125 °C
CAPACITANCE RANGE	47 µF to 470 µF	1 µF to 100 µF	15 µF to 470 µF	15 µF to 470 µF (discrete capacitors) 30 µF to 2800 µF (stacked capacitors)	15 µF to 470 µF (discrete capacitors) 30 µF to 2800 µF (stacked capacitors)
VOLTAGE RANGE	10 V to 35 V	6.3 V to 35 V	16 V to 75 V	16 V to 75 V	16 V to 75 V
CAPACITANCE TOLERANCE	± 20 %	± 20 %	± 10 %, ± 20 %	± 20 %	± 20 %
LEAKAGE CURRENT	0.1 CV				
DISSIPATION FACTOR	10 %	8 % to 14 %	10 % to 12 %	10 % to 12 %	10 % to 12 %
ESR	40 mΩ to 200 mΩ	90 mΩ to 500 mΩ	20 mΩ to 150 mΩ	5 mΩ to 150 mΩ	5 mΩ to 150 mΩ
CASE SIZES	E5, M1, M9, B2	MM, W0, W9, A0, BB	EE, EL	EE, EL, E2, E3, E4, E6, 3E, 6E	EE, E2, E3, E4, E6, 3E, 6E
TERMINATION	100 % tin		100 % tin; tin / lead		Tin / lead

MOLDED CAPACITORS, T50 / T51 / T55 / T56 / 04051 TYPES

PLASTIC TAPE SIZE DIMENSIONS in millimeters

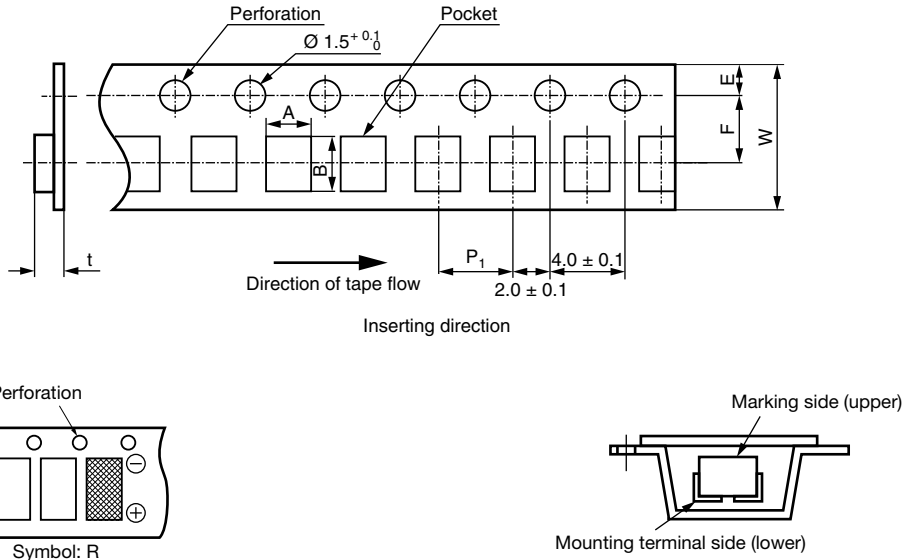

CASE CODE	A ± 0.2	B ± 0.2	W ± 0.3	F ± 0.1	E ± 0.1	P ₁ ± 0.1	t _{max.}
J	1.0	1.8	8.0	3.5	1.75	4.0	1.3
P	1.4	2.2	8.0	3.5	1.75	4.0	1.6
A	1.9	3.5	8.0	3.5	1.75	4.0	2.5
T	3.1	3.8	8.0	3.5	1.75	4.0	1.7
B	3.1	3.8	8.0	3.5	1.75	4.0	2.5
C	3.7	6.3	12.0	5.5	1.75	8.0	3.1
Z	4.8	7.7	12.0	5.5	1.75	8.0	2.6
V	4.8	7.7	12.0	5.5	1.75	8.0	2.6
D	4.8	7.7	12.0	5.5	1.75	8.0	3.4

Note

- A reel diameter of 330 mm is also applicable

LEADFRAMELESS MOLDED CAPACITORS, ALL TYPES

PLASTIC TAPE AND REEL PACKAGING in inches [millimeters]

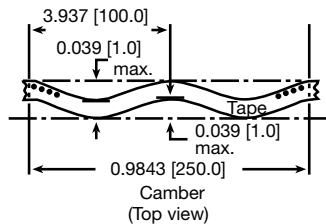
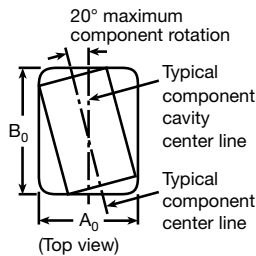
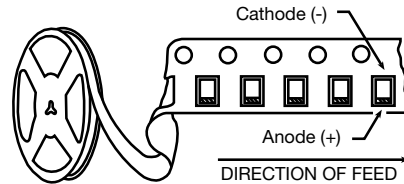
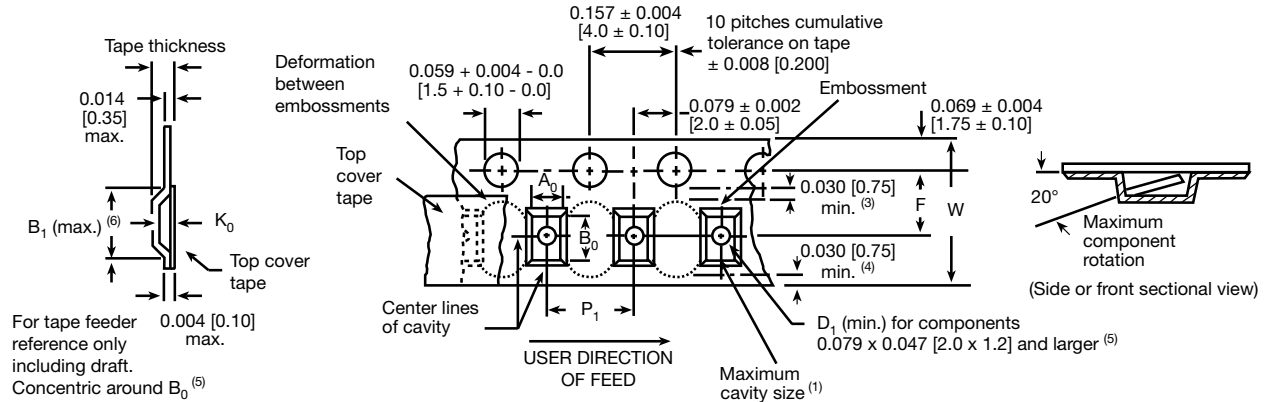

Allowable camber to be 0.039/3.937 [1/100]
Non-cumulative over 9.843 [250.0]

Tape and Reel Specifications: all case sizes are available on plastic embossed tape per EIA-481. Standard reel diameter is 7" [178 mm].

Notes

- Metric dimensions will govern. Dimensions in inches are rounded and for reference only
- (1) A_0 , B_0 , K_0 , are determined by the maximum dimensions to the ends of the terminals extending from the component body and / or the body dimensions of the component. The clearance between the ends of the terminals or body of the component to the sides and depth of the cavity (A_0 , B_0 , K_0) must be within 0.002" (0.05 mm) minimum and 0.020" (0.50 mm) maximum. The clearance allowed must also prevent rotation of the component within the cavity of not more than 20°
- (2) Tape with components shall pass around radius "R" without damage. The minimum trailer length may require additional length to provide "R" minimum for 12 mm embossed tape for reels with hub diameters approaching N minimum
- (3) This dimension is the flat area from the edge of the sprocket hole to either outward deformation of the carrier tape between the embossed cavities or to the edge of the cavity whichever is less
- (4) This dimension is the flat area from the edge of the carrier tape opposite the sprocket holes to either the outward deformation of the carrier tape between the embossed cavity or to the edge of the cavity whichever is less
- (5) The embossed hole location shall be measured from the sprocket hole controlling the location of the embossment. Dimensions of embossment location shall be applied independent of each other
- (6) B_1 dimension is a reference dimension tape feeder clearance only

CARRIER TAPE DIMENSIONS in inches [millimeters]								
CASE CODE	TAPE SIZE	B ₁ (MAX.) ⁽¹⁾	D ₁ (MIN.)	F	K ₀ (MAX.)	P ₁	P ₂	W
E5	12 mm	0.329 [8.35]	0.059 [1.5]	0.217 ± 0.002 [5.50 ± 0.05]	0.071 [1.8]	0.315 ± 0.004 [8.0 ± 0.10]	0.079 ± 0.002 [2.00 ± 0.05]	0.476 ± 0.008 [12.1 ± 0.20]
MM ⁽²⁾	8 mm	0.075 [1.91]	0.02 [0.5]	0.138 [3.5]	0.043 [1.10]	0.157 [4.0]	0.079 ± 0.002 [2.00 ± 0.05]	0.315 [8.0]
M1, M9	12 mm	0.32 [8.2]	0.059 [1.5]	0.217 ± 0.002 [5.5 ± 0.05]	0.094 [2.39]	0.315 ± 0.04 [8.0 ± 1.0]	0.079 ± 0.002 [2.00 ± 0.05]	0.472 + 0.012 / - 0.004 [12.0 + 0.3 / - 0.10]
W9	8 mm	0.126 [3.20]	0.030 [0.75]	0.138 [3.5]	0.045 [1.15]	0.157 [4.0]	0.079 ± 0.002 [2.00 ± 0.05]	0.315 [8.0]
W0	8 mm	0.126 [3.20]	0.030 [0.75]	0.138 [3.5]	0.045 [1.15]	0.157 [4.0]	0.079 ± 0.002 [2.00 ± 0.05]	0.315 [8.0]
A0	8 mm	-	0.02 [0.5]	0.138 [3.5]	0.049 [1.25]	0.157 [4.0]	0.079 ± 0.002 [2.00 ± 0.05]	0.315 [8.0]
BB	8 mm	0.157 [4.0]	0.039 [1.0]	0.138 [3.5]	0.087 [2.22]	0.157 [4.0]	0.079 ± 0.002 [2.00 ± 0.05]	0.315 [8.0]
EE, EL	12 mm	0.32 [8.2]	0.059 [1.5]	0.217 ± 0.002 [5.5 ± 0.05]	0.175 [4.44]	0.315 ± 0.04 [8.0 ± 1.0]	0.079 ± 0.002 [2.00 ± 0.05]	0.472 + 0.012 / - 0.004 [12.0 + 0.3 / - 0.10]
B2	8 mm	0.157 [4.0]	0.039 [1.0]	0.138 [3.5]	0.057 [1.45]	0.157 [4.0]	0.079 ± 0.002 [2.00 ± 0.05]	0.315 [8.0]
D ⁽³⁾	16 mm	0.321 [8.16]	0.059 [1.5]	0.295 ± 0.004 [7.50 ± 0.1]	0.308 [7.83]	0.472 ± 0.004 [12.00 ± 0.1]	0.079 ± 0.004 [2.00 ± 0.1]	0.630 ± 0.012 [16.00 ± 0.3]

Notes

- (1) For reference only
- (2) Standard packaging of MM case is with paper tape. Plastic tape is available per request
- (3) Tape thickness 0.018 [0.45] max.

PAPER TAPE AND REEL PACKAGING DIMENSIONS in inches [millimeters]											
CASE SIZE	TAPE SIZE	A ₀	B ₀	D ₀	P ₀	P ₁	P ₂	E	F	W	T
MM	8 mm	0.041 ± 0.002 [1.05 ± 0.05]	0.071 ± 0.002 [1.8 ± 0.05]	0.06 ± 0.004 [1.5 ± 0.1]	0.157 ± 0.004 [4.0 ± 0.1]	0.157 ± 0.004 [4.0 ± 0.1]	0.079 ± 0.002 [2.0 ± 0.05]	0.069 ± 0.004 [1.75 ± 0.1]	0.0138 ± 0.002 [3.5 ± 0.05]	0.315 ± 0.008 [8.0 ± 0.2]	0.037 ± 0.002 [0.95 ± 0.05]
M0	8 mm	0.049 ± 0.002 [1.25 ± 0.05]	0.081 ± 0.002 [2.05 ± 0.05]	0.06 ± 0.004 [1.5 ± 0.1]	0.157 ± 0.004 [4.0 ± 0.1]	0.157 ± 0.004 [4.0 ± 0.1]	0.079 ± 0.002 [2.0 ± 0.05]	0.069 ± 0.004 [1.75 ± 0.1]	0.0138 ± 0.002 [3.5 ± 0.05]	0.315 ± 0.008 [8.0 ± 0.2]	0.041 ± 0.002 [1.05 ± 0.05]

Note

- (1) A₀, B₀ are determined by the maximum dimensions to the ends of the terminals extending from the component body and / or the body dimensions of the component. The clearance between the ends of the terminals or body of the component to the sides and depth of the cavity (A₀, B₀) must be within 0.002" (0.05 mm) minimum and 0.020" (0.50 mm) maximum. The clearance allowed must also prevent rotation of the component within the cavity of not more than 20°

PACKING AND STORAGE

Polymer capacitors meet moisture sensitivity level rating (MSL) of 3 or 4 as specified in IPC/JEDEC® J-STD-020 and are dry packaged in moisture barrier bags (MBB) per J-STD-033. MSL for each particular family is defined in the datasheet - either in “Features” section or “Standard Ratings” table. Level 3 specifies a floor life (out of bag) of 168 hours and level 4 specifies a floor life of 72 hours at 30 °C maximum and 60 % relative humidity (RH). Unused capacitors should be re-sealed in the MBB with fresh desiccant. A moisture strip (humidity indicator card) is included in the bag to assure dryness. To remove excess moisture, capacitors can be dried at 40 °C (standard “dry box” conditions).

For detailed recommendations please refer to J-STD-033.

RECOMMENDED REFLOW PROFILES		
Vishay recommends no more than 3 cycles of reflow in accordance with J-STD-020.		
PROFILE FEATURE	SnPb EUTECTIC ASSEMBLY	LEAD (Pb)-FREE ASSEMBLY
PREHEAT AND SOAK		
Temperature min. ($T_{Smin.}$)	100 °C	150 °C
Temperature max. ($T_{Smax.}$)	150 °C	200 °C
Time (t_s) from ($T_{Smin.}$ to $T_{Smax.}$)	60 s to 120 s	60 s to 120 s
RAMP UP		
Ramp-up rate (T_L to T_p)	3 °C/s maximum	
Liquidus temperature (T_L)	183 °C	217 °C
Time (t_L) maintained above T_L	60 s to 150 s	
Peak package body temperature (T_p) max.	Depends on type and case - see table below	
Time (t_p) within 5 °C of the peak max. temperature	20 s	5 s ⁽¹⁾
RAMP DOWN		
Ramp-down rate (T_p to T_L)	6 °C/s maximum	
Time from 25 °C to peak temperature	6 min maximum	8 min maximum

Note

⁽¹⁾ For T27, lead (Pb)-free capacitors $t_p = 30$ s

PEAK PACKAGE BODY TEMPERATURE (T _p) MAXIMUM			
TYPE	CASE CODE	PEAK PACKAGE BODY TEMPERATURE (T _p) MAX.	
		SnPb EUTECTIC ASSEMBLY	LEAD (Pb)-FREE ASSEMBLY
T27	D	220 °C	245 °C
T55	J, P, A, T, B, C, Z, V, D	n/a	260 °C
T52	E5, M1, M9, B2		260 °C
T58	MM, W9, W0, A0, BB		260 °C
T50	D		260 °C
T51	D, V		260 °C
T56	B, V		260 °C
T56	D		250 °C
T59	EE, EL		220 °C
T54	EL, 3E, 6E, EE, E2, E3, E4, E6	220 °C	250 °C
20021	3E, 6E, EE, E2, E3, E4, E6	220 °C	n/a
04051	D	220 °C	n/a
04051	B	235 °C	n/a
M327001	D	220 °C	n/a
M327001	B, C	235 °C	n/a

Notes

- T50, T51, T52, T55, T56 (B, V cases), and T58 capacitors are process sensitive. PSL classification to JEDEC J-STD-075: R4G
- T54, T59, and T56 (D case) capacitors with 100 % tin termination are process sensitive. PSL classification to JEDEC J-STD-075: R6G

MOLDED CAPACITORS, T50 / T51 / T55 / T56 / 04051 TYPES

PAD DIMENSIONS in millimeters						
CASE / DIMENSIONS	CAPACITOR SIZE		PAD DIMENSIONS			
	L	W	G (max.)	Z (min.)	X (min.)	Y (Ref.)
J	1.6	0.8	0.7	2.5	1.0	0.9
P	2.0	1.25	0.5	2.6	1.2	1.05
A	3.2	1.6	1.1	3.8	1.5	1.35
T / B	3.5	2.8	1.4	4.1	2.7	1.35
C	5.8	3.2	2.9	6.9	2.7	2.0
Z / V / D	7.3	4.3	4.1	8.2	2.9	2.05

LEADFRAMELESS MOLDED CAPACITORS T52 / T58

PAD DIMENSIONS in inches [millimeters]					
FAMILY	CASE CODE	A (NOM.)	B (MIN.)	C (NOM.)	D (MIN.)
T52	E5	0.094 [2.40]	0.077 [1.95]	0.180 [4.57]	0.333 [8.46]
	M1, M9	0.178 [4.52]	0.098 [2.48]	0.138 [3.50]	0.333 [8.46]
	B2	0.081 [2.06]	0.057 [1.44]	0.070 [1.77]	0.183 [4.64]
T58	MM	0.024 [0.61]	0.027 [0.70]	0.025 [0.64]	0.080 [2.03]
	W0, W9	0.035 [0.89]	0.029 [0.74]	0.041 [1.05]	0.099 [2.52]
	A0	0.047 [1.19]	0.042 [1.06]	0.065 [1.65]	0.148 [3.76]
	BB	0.094 [2.39]	0.044 [1.11]	0.072 [1.82]	0.159 [4.03]

LEADFRAMELESS MOLDED CAPACITORS T59 / T54 / 20021

PAD DIMENSIONS in inches [millimeters]					
FAMILY	CASE CODE	A (NOM.)	B (MIN.)	C (NOM.)	D (MIN.)
T59 / T54	EE	0.209 [5.30]	0.098 [2.50]	0.169 [4.30]	0.366 [9.30]
	EL	0.098 [2.50]	0.098 [2.50]	0.169 [4.30]	0.366 [9.30]
T54	E2 / E3	0.128 [3.24]	0.120 [3.04]	0.154 [3.92]	0.394 [10.0]
	E4 / E6	0.301 [7.64]	0.120 [3.04]	0.154 [3.92]	0.394 [10.0]
	3E	0.482 [12.24]	0.120 [3.04]	0.154 [3.92]	0.394 [10.0]
	6E	0.482 [12.24]	0.120 [3.04]	0.154 [3.92]	0.394 [10.0]
20021	EE	0.209 [5.30]	0.098 [2.50]	0.169 [4.30]	0.366 [9.30]

HERMETICALLY SEALED CAPACITOR T27 TYPE

PAD DIMENSIONS in inches [millimeters]				
CASE CODE	A (MIN.)	B (NOM.)	C (NOM.)	D (NOM.)
D	0.295 [7.50]	0.138 [3.50]	0.100 [2.50]	0.374 [9.50]

GUIDE TO APPLICATION

- AC Ripple Current:** the maximum allowable ripple current shall be determined from the formula:

$$I_{RMS} = \sqrt{\frac{P}{R_{ESR}}}$$

where,

P = power dissipation in W at +45 °C as given in the tables in the product datasheets.

R_{ESR} = the capacitor equivalent series resistance at the specified frequency.

- AC Ripple Voltage:** the maximum allowable ripple voltage shall be determined from the formula:

$$V_{RMS} = Z \sqrt{\frac{P}{R_{ESR}}}$$

or, from the formula:

$$V_{RMS} = I_{RMS} \times Z$$

where,

P = power dissipation in W at +45 °C as given in the tables in the product datasheets.

R_{ESR} = The capacitor equivalent series resistance at the specified frequency.

Z = The capacitor impedance at the specified frequency.

- The tantalum capacitors must be used in such a condition that the sum of the working voltage and ripple voltage peak values does not exceed the rated voltage as shown in figure below.

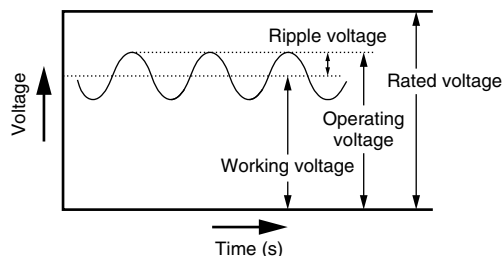

- Temperature Derating:** power dissipation is affected by the heat sinking capability of the mounting surface. If these capacitors are to be operated at temperatures above +45 °C, the permissible ripple current (or voltage) shall be calculated using the derating coefficient as shown in the table below:

MAXIMUM RIPPLE CURRENT TEMPERATURE DERATING FACTOR	
≤ 45 °C	1.0
55 °C	0.8
85 °C	0.6
105 °C	0.4
125 °C	0.25

- Reverse Voltage:** the capacitors are not intended for use with reverse voltage applied. However, they are capable of withstanding momentary reverse voltage peaks, which must not exceed the following values:

At 25 °C: 10 % of the rated voltage or 1 V, whichever is smaller.

At 85 °C: 5 % of the rated voltage or 0.5 V, whichever is smaller.

At 105 °C: 3 % of the rated voltage or 0.3 V, whichever is smaller.

- Mounting Precautions:**

- Soldering:** capacitors can be attached by conventional soldering techniques; vapor phase, convection reflow, infrared reflow, wave soldering, and hot plate methods. The soldering profile charts show recommended time / temperature conditions for soldering. Preheating is recommended. The recommended maximum ramp rate is 3 °C per second. Attachment with a soldering iron is not recommended due to the difficulty of controlling temperature and time at temperature. The soldering iron must never come in contact with the capacitor. For details see www.vishay.com/doc?40214.

- Limit Pressure on Capacitor Installation with Mounter:** pressure must not exceed 4.9 N with a tool end diameter of 1.5 mm when applied to the capacitors using an absorber, centering tweezers, or similar (maximum permitted pressurization time: 5 s). An excessively low absorber setting position would result in not only the application of undue force to the capacitors but capacitor and other component scattering, circuit board wiring breakage, and / or cracking as well, particularly when the capacitors are mounted together with other chips having a height of 1 mm or less.

- Flux Selection**

- Select a flux that contains a minimum of chlorine and amine.

- After flux use, the chlorine and amine in the flux remain must be removed.

- Cleaning After Mounting:** the following solvents are usable when cleaning the capacitors after mounting. Never use a highly active solvent.

- Halogen organic solvent (HCFC225, etc.)
- Alcoholic solvent (IPA, ethanol, etc.)
- Petroleum solvent, alkali saponifying agent, water, etc.

Circuit board cleaning must be conducted at a temperature of not higher than 50 °C and for an immersion time of not longer than 30 minutes. When an ultrasonic cleaning method is used, cleaning must be conducted at a frequency of 48 kHz or lower, at an vibrator output of 0.02 W/cm³, at a temperature of not higher than 40 °C, and for a time of 5 minutes or shorter.

Notes

- Care must be exercised in cleaning process so that the mounted capacitor will not come into contact with any cleaned object or the like or will not get rubbed by a stiff brush or similar. If such precautions are not taken particularly when the ultrasonic cleaning method is employed, terminal breakage may occur
- When performing ultrasonic cleaning under conditions other than stated above, conduct adequate advance checkout



Disclaimer

ALL PRODUCT, PRODUCT SPECIFICATIONS AND DATA ARE SUBJECT TO CHANGE WITHOUT NOTICE TO IMPROVE RELIABILITY, FUNCTION OR DESIGN OR OTHERWISE.

Vishay Intertechnology, Inc., its affiliates, agents, and employees, and all persons acting on its or their behalf (collectively, "Vishay"), disclaim any and all liability for any errors, inaccuracies or incompleteness contained in any datasheet or in any other disclosure relating to any product.

Vishay makes no warranty, representation or guarantee regarding the suitability of the products for any particular purpose or the continuing production of any product. To the maximum extent permitted by applicable law, Vishay disclaims (i) any and all liability arising out of the application or use of any product, (ii) any and all liability, including without limitation special, consequential or incidental damages, and (iii) any and all implied warranties, including warranties of fitness for particular purpose, non-infringement and merchantability.

Statements regarding the suitability of products for certain types of applications are based on Vishay's knowledge of typical requirements that are often placed on Vishay products in generic applications. Such statements are not binding statements about the suitability of products for a particular application. It is the customer's responsibility to validate that a particular product with the properties described in the product specification is suitable for use in a particular application. Parameters provided in datasheets and / or specifications may vary in different applications and performance may vary over time. All operating parameters, including typical parameters, must be validated for each customer application by the customer's technical experts. Product specifications do not expand or otherwise modify Vishay's terms and conditions of purchase, including but not limited to the warranty expressed therein.

Hyperlinks included in this datasheet may direct users to third-party websites. These links are provided as a convenience and for informational purposes only. Inclusion of these hyperlinks does not constitute an endorsement or an approval by Vishay of any of the products, services or opinions of the corporation, organization or individual associated with the third-party website. Vishay disclaims any and all liability and bears no responsibility for the accuracy, legality or content of the third-party website or for that of subsequent links.

Vishay products are not designed for use in life-saving or life-sustaining applications or any application in which the failure of the Vishay product could result in personal injury or death unless specifically qualified in writing by Vishay. Customers using or selling Vishay products not expressly indicated for use in such applications do so at their own risk. Please contact authorized Vishay personnel to obtain written terms and conditions regarding products designed for such applications.

No license, express or implied, by estoppel or otherwise, to any intellectual property rights is granted by this document or by any conduct of Vishay. Product names and markings noted herein may be trademarks of their respective owners.