

MDS Medical AC-DC Open Frame

400 W / MDS-400AUS□ BA

400AUS



Highlights & Features

- Safety Approvals to IEC 60601-1 & IEC 62368-1
- Risk management report available
- Low touch current (<0.1 mA Normal & <0.3 mA single fault)
- Over-Voltage/Load/Temperature & Short Circuit protections
- 2 Million Hours MTBF
- 2 x MOPP (means of patient protection)
- 3 years warranty

Safety Standards



CB Certified for worldwide use

Model Number: MDS-400AUS□ BA
Unit Weight: 910 grams (32.1 ounces)
Dimensions (L x W x H): 198.0 x 97.0 x 41.5 mm
 7.80 x 3.82 x 1.63 in

General Description

The MDS series of embedded power supply comes with universal AC input at 90 Vac to 264 Vac. Other features include low earth leakage, risk management report available and the electric shock protection comply with 2 x MOPP. The MDS series is certified for EMC standards according to EN/BS EN 55011 for industrial, scientific and medical (ISM) radio-frequency equipment and EN/BS EN 55032 for Information Technology Equipment (ITE) radio-frequency equipment.

The MDS series come with both medical and ITE safety approvals including UL/cUL/CE and CB certification and are fully compliant with RoHS Directive-for environmental protection.

Model Information

Medical AC-DC Open Frame

Model Number	Input Voltage Range	Output Voltage	Conversion Current Output	Forced Air Current Output
MDS-400AUS19 BA	90-264 Vac	19 Vdc	15.8 A	21.1 A*
MDS-400AUS24 BA	90-264 Vac	24 Vdc	12.5 A	16.67 A*
MDS-400AUS30 BA	90-264 Vac	30 Vdc	11.67 A	13.3 A*

* With 200LFM force air

Model Numbering

MDS <small>Delta Medical power Supply</small>	-	400 <small>Max wattage in the product series. Maybe lower at some voltage. 400 → 400 W</small>	AUS <small>Family Code</small>	□ <small>Output Voltage Single Output: 19 for 19 V 24 for 24 V 30 for 30 V</small>	□ <small>Blank</small>	BA
---	---	--	--	---	---------------------------	-----------

MDS Medical AC-DC Open Frame

400 W / MDS-400AUS□ BA

Specifications

Input Ratings / Characteristics

Model Number	MDS-400AUS19 BA	MDS-400AUS24 BA	MDS-400AUS30 BA
Nominal Input Voltage	100-240 Vac		
Input Voltage Range	90-264 Vac		
Nominal Input Frequency	50-60 Hz		
Input Frequency Range	47-63 Hz		
Input Current (max)	5.5 A @ 90 Vac, 2.7 A @ 264 Vac		
Efficiency (typ.)	91.38%, Reference Fig.1-1	91.94%, Reference Fig.1-2	92.51%, Reference Fig.1-3
Standby Power (max)	1.2 W		
Inrush Current (typ.)	60 A @ 115 Vac, 60 A @ 230 Vac		
Earth Leakage Current (max)	0.1 mA @ 240 Vac NC ¹ , 0.3 mA @ 264 Vac SFC ²		

1) NC: normal condition

2) SFC: single fault condition

MDS-400AUS19 BA

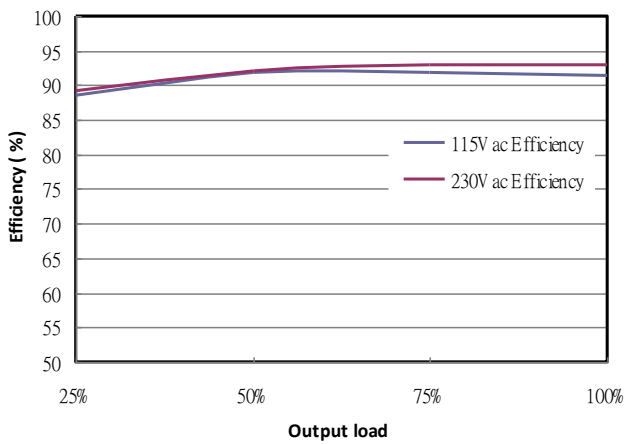

Fig.1-1 MDS-400AUS19 BA Efficiency versus output load

MDS-400AUS24 BA

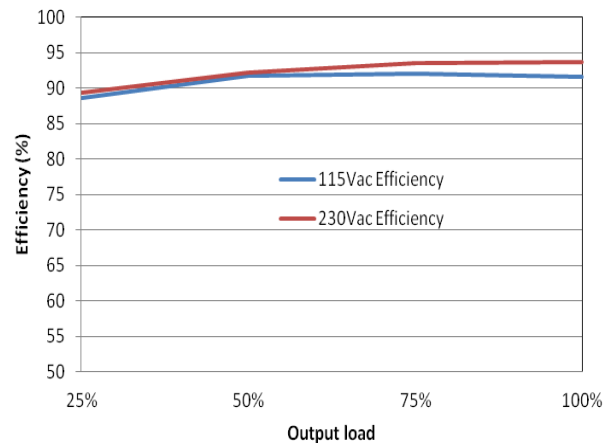

Fig.1-2 MDS-400AUS24 BA Efficiency versus output load

MDS-400AUS30 BA

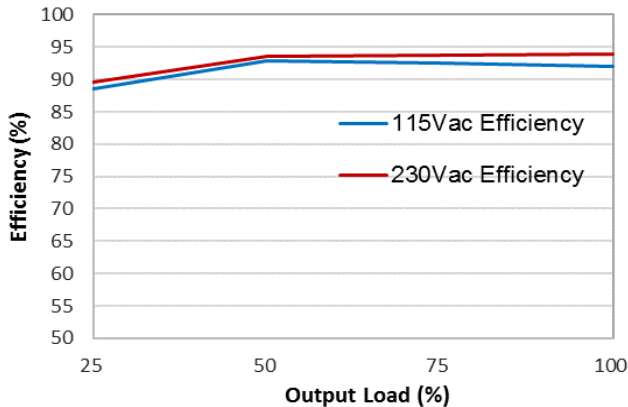

Fig.1-3 MDS-400AUS30 BA Efficiency versus output load

MDS Medical AC-DC Open Frame

400 W / MDS-400AUS□ BA

Output Ratings / Characteristics

Model Number	MDS-400AUS19 BA	MDS-400AUS24 BA	MDS-400AUS30 BA
Nominal Output Voltage	19 Vdc	24 Vdc	30 Vdc
Output Voltage Tolerance	± 2%		
Output Current	21.1 A with 200 LFM force air, 15.8 A for convection	16.67 A with 200 LFM force air, 12.5 A for convection	13.33 A with 200 LFM force air, 11.67 A for convection
Output Power	400 W with 200 LFM force air, 300 W for convection	400 W with 200 LFM force air, 300 W for convection	400 W with 200 LFM force air, 350 W for convection
Line Regulation (max)	±0.5%	±0.5%	±1%
Fan Supply	12 V 0.25 A	12 V 0.25 A	N/A
Remote Sense	Compensates for up to 500mV voltage drop		
Ripple & Noise (typ.)*	±1% pk-pk @ Full load	±1% pk-pk @ Full load	±1.5% pk-pk @ Full load
Hold-up Time (min)	12 ms @ 115 Vac		

*Ripple & Noise is measured with AC coupling mode, and in parallel to end with 0.47 uF ceramic capacitor & 10 uF electrolytic capacitor.

Ripple & Noise measurement circuit

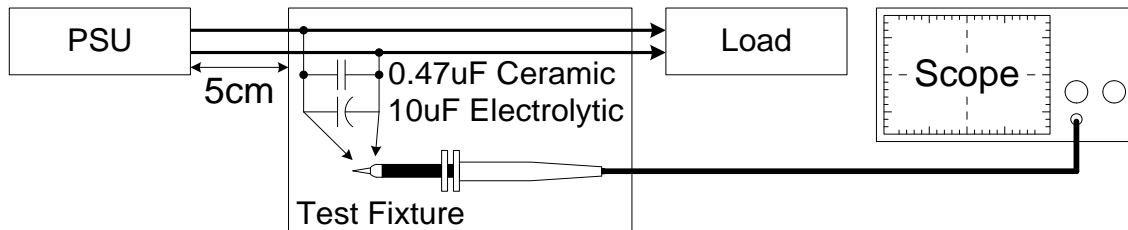

MDS Medical AC-DC Open Frame

400 W / MDS-400AUS□ BA

Mechanical

Model Number		MDS-400AUS19 BA	MDS-400AUS24 BA	MDS-400AUS30 BA
Case Chassis		AL1100F (with black electro coating)		
Case Cover		NA		
Dimensions (L x W x H)		198.0 x 97.0 x 41.5 mm (7.80 x 3.82 x 1.63 in)		
Unit Weight		910 grams (32.1 ounces)		
Power de-rating curve		See Fig. 3-1 & Fig. 3-2 (400 W with forced air flow)		
Terminal	Input	DECA: T33-BM1103A301		
	Output	DECA: T33-BM1104A301		
DC Fan	Output	JWT: A2508WV0-2P	JWT: A2508WV0-2P	NA

Environment

Surrounding Air Temperature	Operating	-10°C to +70°C		
	Storage	-40°C to +85°C		
Power De-rating	-10°C to +50°C 100% load 50°C to 70°C with load de-rate power			
Operating Humidity	5-95% RH (Non-Condensing)			
Storage Humidity	5-95% RH (Non-Condensing)			
Operating Altitude		Up to 3,000 meters (up to 9,842 feet or 106-70 kPa)	Up to 3,000 meters (up to 9,842 feet or 106-70 kPa)	Up to 5,000 meters (up to 16,404 feet or 106-54 kPa)
Shock Test	Non-Operating	50 G, 11 ms, 3 shocks for each direction		
Vibration	Non-Operating	5-500 Hz, 2.09 Grms, 20 minute for each three axis		

Protections

Overtoltage (max)	150%, Latch Mode			
Over load / Over current (max)	130% of rated load current, Hiccup Mode, (Non-Latching, Auto-Recovery)			
Over Temperature	Hiccup Mode	Latch Mode	Hiccup Mode	
Short Circuit	Hiccup Mode, (Non-Latching, Auto-Recovery)			
Protection Against Shock	Class I with PE* connection			

*PE: Protective Earth

Reliability Data

MTBF	2 Million Hrs based on Telecordia SR-332	2 Million Hrs based on Telecordia SR-332	500K Hours based on Telecordia SR-332
------	---	---	--

MDS Medical AC-DC Open Frame

400 W / MDS-400AUS □ BA

Safety Standards / Directives

Medical Safety	All models	IEC60601-1 CB report EN60601-1 CAN/CSA-C22.2 No. 60601-1 ANSI/AAMI ES60601-1
ITE	All models	IEC60950-1, IEC62368-1 UL 60950-1 +CSA C22.2 No. 60950-1-07 UL 62368-1 +CSA C22.2 No. 62368-1-14 CCC GB 17625.1; GB 4943.1; GB/T 9254.1
CE		In conformance with EMC Directive 2014/30/EU and Low Voltage Directive 2014/35/EU EN 60601-1: 2006 + A11: 2011 + A1L 2013 + A12: 2014 & EN 60601-1-2: 2015
UKCA		In conformance with Electrical Equipment (Safety) Regulations 2016 and Electromagnetic Compatibility Regulations 2016, Medical Devices Regulations 2002 (UK MDR 2002)
Galvanic Isolation	Input to Output	4000 Vac
	Input to Ground	1500 Vac
	Output to Ground	500 Vac

EMC (Compliant with IEC 60601-1-2 4th Ed. Requirements)

EMC / Emissions		EN/BS EN 55011, EN/BS EN 55032, FCC Title 47:Class B
Harmonic Current	IEC 61000-3-2	Meet Class D limit
Voltage Flicker	IEC 61000-3-3	
Immunity to		
Electrostatic Discharge	IEC 61000-4-2	Level 4 Criteria A ¹⁾ Air Discharge: 15 kV Contact Discharge: 8 kV
Radiated Field	IEC 61000-4-3	Criteria A ¹⁾ 80 MHz-2700 MHz, 10 V/m AM modulation 385 MHz-5785 MHz, 28 V/m Pulse mode and other modulation
Electrical Fast Transient / Burst	IEC 61000-4-4	Level 3 Criteria A ¹⁾ : 2 kV
Surge	IEC 61000-4-5	Level 3 Criteria A ¹⁾ Common Mode ³⁾ : 2 kV Differential Mode ⁴⁾ : 1 kV
Conducted	IEC 61000-4-6	Level 2 Criteria A ¹⁾ 150 kHz-80 MHz, 3 Vrms, 6 Vrms at ISM bands and Amateur radio bands
Power Frequency Magnetic Fields	IEC 61000-4-8	Criteria A ¹⁾ Magnetic field strength 30 A/m
Voltage Dips	IEC 61000-4-11	Criteria A ¹⁾ 0% U _T , 0.5 cycle (10ms), 0°/45°/90°/135°/180°/225°/270°/315°/360° Criteria A ¹⁾ 0% U _T , 1 cycle (20ms), 0° Criteria B ²⁾ 70% U _T , 25 cycle (500ms), 0° Criteria B ²⁾ 0% U _T , 250 cycle (5000ms), 0°

1) Criteria A: Normal performance within the specification limits

2) Criteria B: Output out of regulation, or shuts down during test. Automatically restore to normal operation after test.

3) Asymmetrical: Common mode (Line to earth)

4) Symmetrical: Differential mode (Line to line)

MDS Medical AC-DC Open Frame

400 W / MDS-400AUS□ BA

Block Diagram

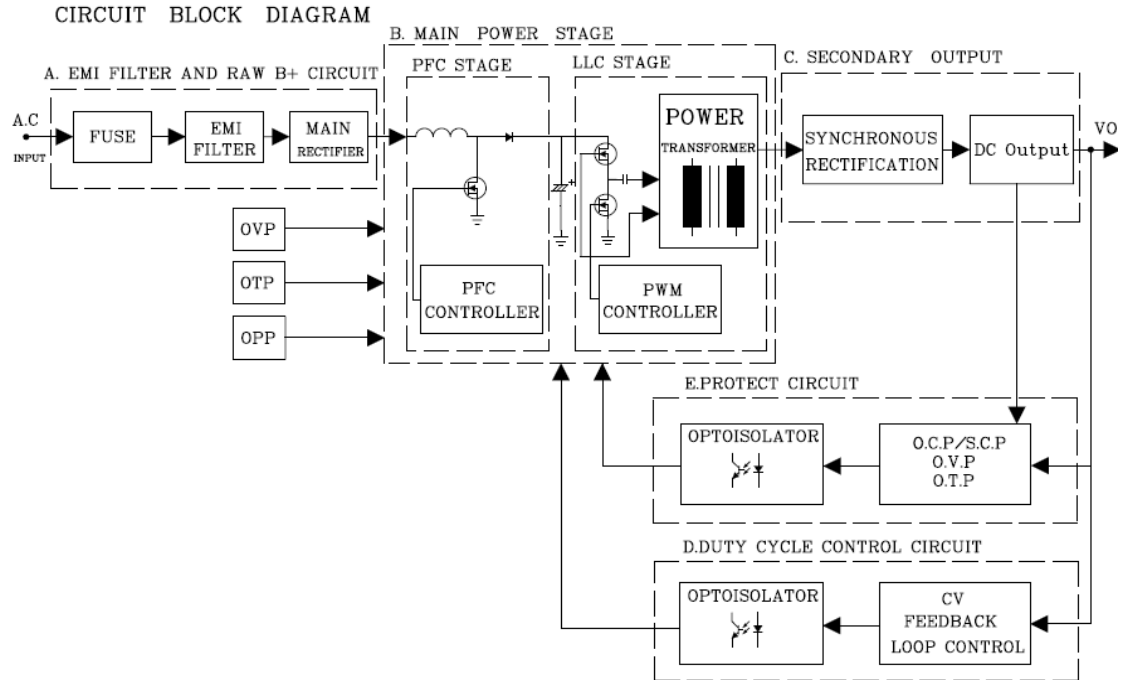

MDS Medical AC-DC Open Frame

400 W / MDS-400AUS□ BA

Dimensions (For MDS-400AUS19/24 BA)

L x W x H: 97.0 x 198.0 x 41.5 mm (3.82 x 7.80 x 1.63 in)

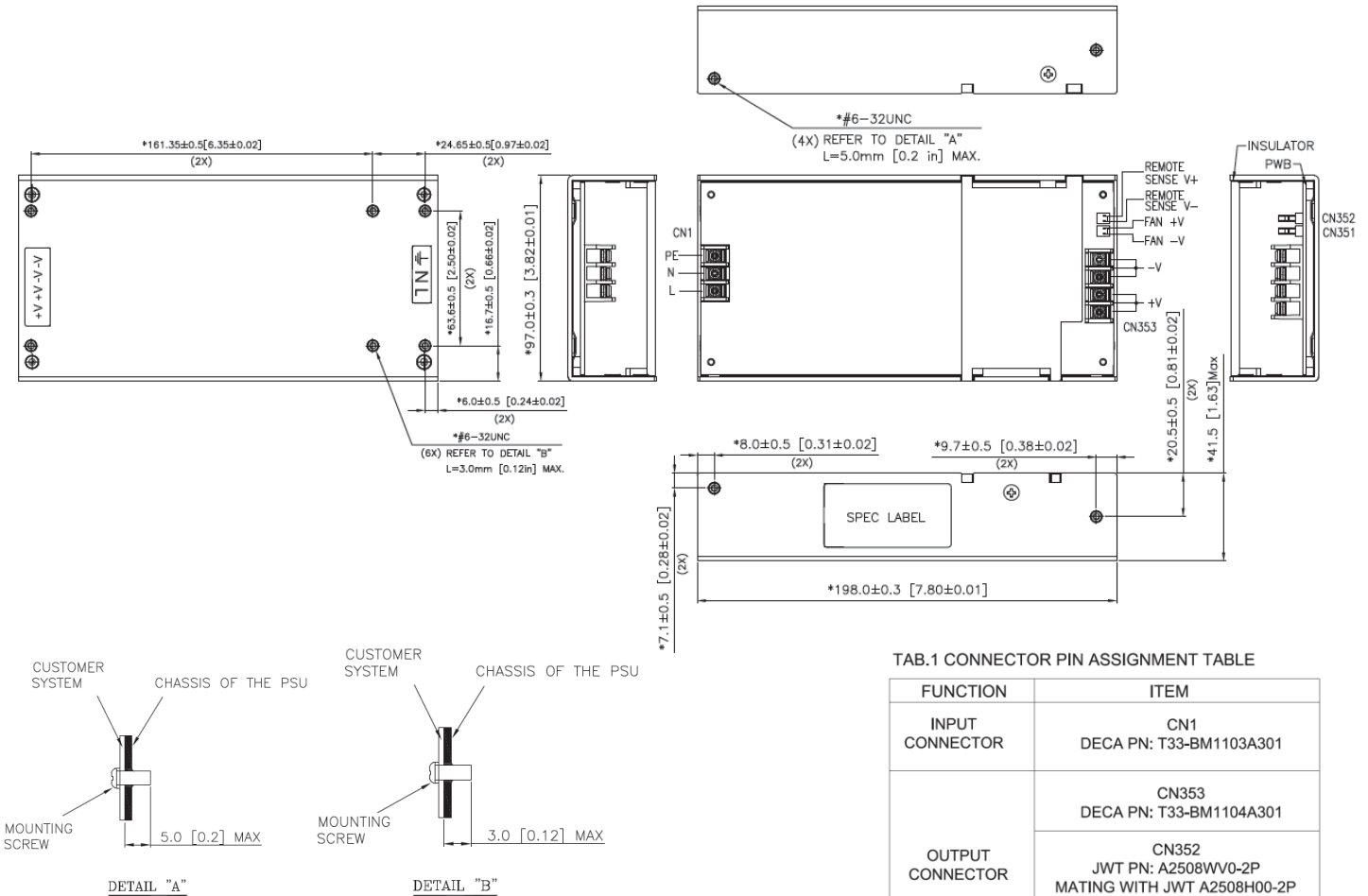

TAB.1 CONNECTOR PIN ASSIGNMENT TABLE

FUNCTION	ITEM
INPUT CONNECTOR	CN1 DECA PN: T33-BM1103A301
	CN353 DECA PN: T33-BM1104A301
OUTPUT CONNECTOR	CN352 JWT PN: A2508WV0-2P MATING WITH JWT A2508H00-2P
	CN351 JWT PN: A2508WV0-2P MATING WITH JWT A2508H00-2P

Notes

- Dimensions are in mm (inches)
- There are two locations where assembled power supply is connected to the customer's product
 - Bottom mounting, use (6X) #6-32 UNC screws to affix assembled power supply to product's enclosure. Thread must be withstand 12 Kgf-cm (10.4 lb-in) min. Maximum allowed screw penetration is 3.0 mm (0.12 inch).
 - Side mounting, use (4X) #6-32 UNC screws to affix one side of assembled power supply to the product's enclosure. Thread must be withstand 12 Kgf-cm (10.4 lb-in) min. Maximum allowed screw penetration is 5.0 mm (0.2 inch)
- CN1/CN353, maximum torque 13.8 kgf.cm (12.0 inch.lbs).

MDS Medical AC-DC Open Frame

400 W / MDS-400AUS□ BA

Dimensions (For MDS-400AUS30 BA)

L x W x H: 198.0 x 97.0 x 41.5 mm (7.80 x 3.82 x 1.63 in)

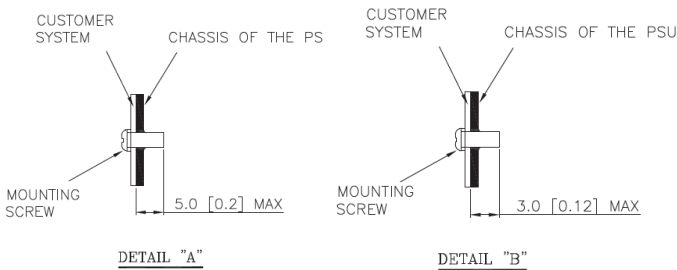
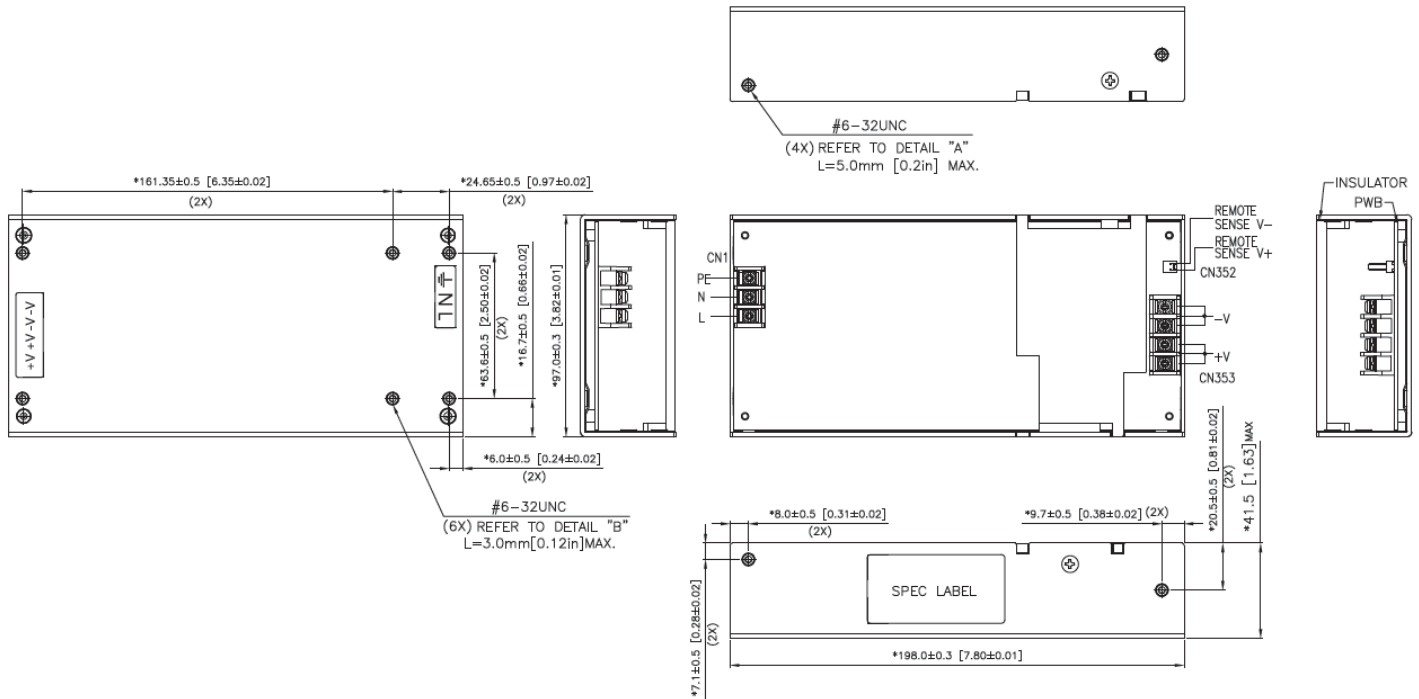

TAB.1 CONNECTOR PIN ASSIGNMENT TABLE

FUNCTION	ITEM
INPUT CONNECTOR	CN1 DECA PN: T33-BM1103A301
	CN353 DECA PN: T33-BM1104A301
OUTPUT CONNECTOR	CN352 JWT PN: A2543WV0-2P MATING WITH JWT PN:A2543H00-2P

Notes

- Dimensions are in mm (inches)
- There are two locations where assembled power supply is connected to the customer's product
 - Bottom mounting, use (6X) #6-32 UNC screws to affix assembled power supply to product's enclosure. Thread must be withstand 12 Kgf-cm (10.4 lb-in) min. Maximum allowed screw penetration is 3.0 mm (0.12 in).
 - Side mounting, use (4X) #6-32 UNC screws to affix one side of assembled power supply to the product's enclosure. Thread must be withstand 12 Kgf-cm (10.4 lb-in) min. Maximum allowed screw penetration is 5.0mm (0.2 inch)
- CN1/CN353, maximum torque 13.8 kgf.cm (12.0 inch.lbs).

MDS Medical AC-DC Open Frame

400 W / MDS-400AUS□ BA

De-rating Curve

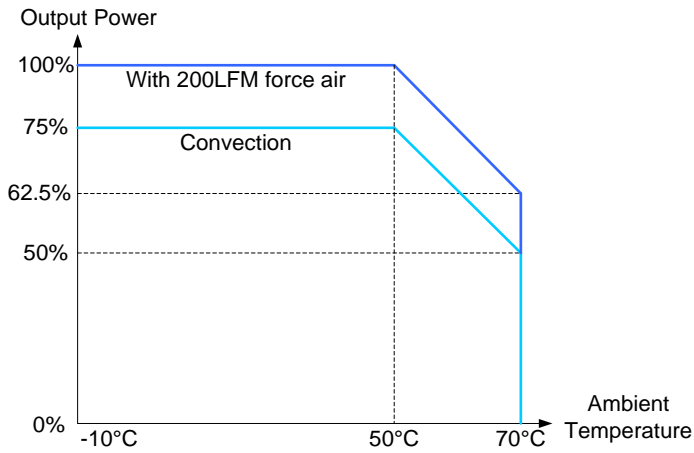

Fig.3-1 MDS-400AUS19&24V de-rating curve

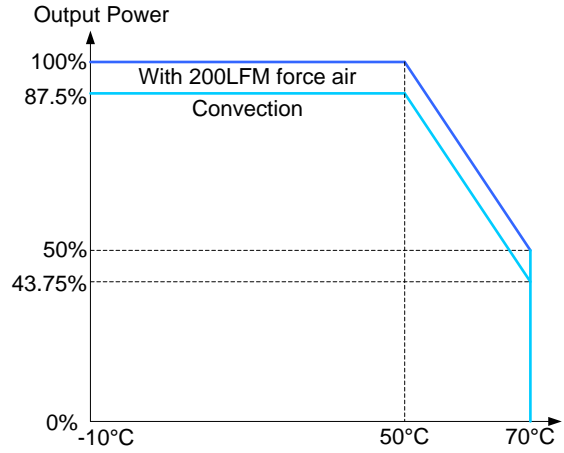

Fig.3-2 MDS-400AUS30V de-rating curve

Functions

Start-up Time

The time required for the output voltage (V_o) to reach 90% of its set value, after the input AC voltage is applied.

Rise Time

The time required for the output voltage (V_o) to change from 10% to 90% of its steady state value.

Hold-up Time

Hold up time is the time when the AC input collapses and output voltage retains regulation for a certain period of time. The time required for the output to reach 95% of its set value, after the input voltage is removed.

■ Graph illustrating the Start-up Time, Rise Time, and Hold-up Time

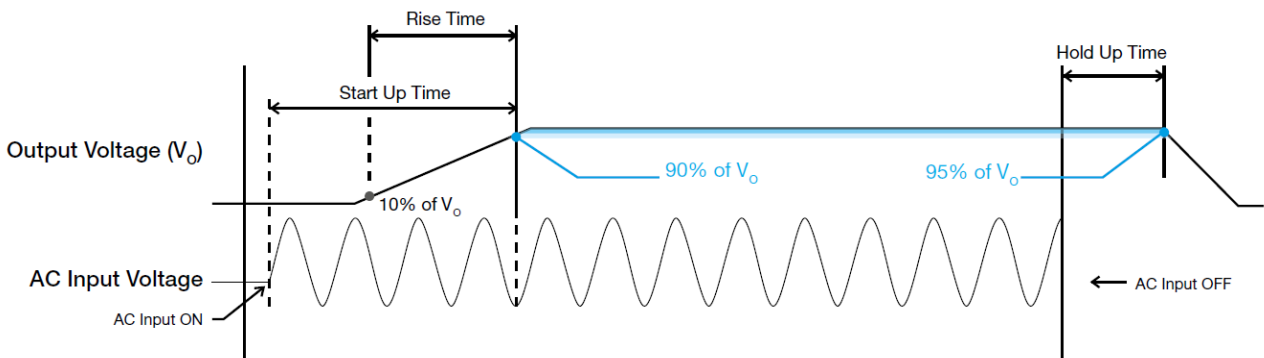

MDS Medical AC-DC Open Frame

400 W / MDS-400AUS□ BA

Dynamic Response

The power supply output voltage will remain within $\pm 3\%$ of its steady state value, when subjected to a dynamic load change from 50 to 100% of its rated current.

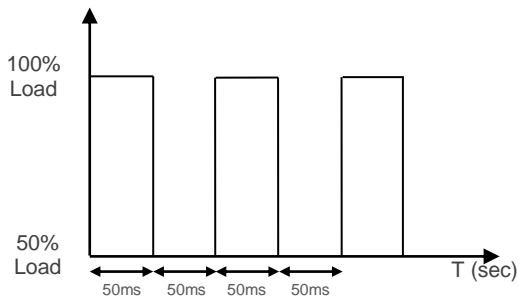

Inrush Current

Inrush current is the input current that occurs when the input voltage is first applied. For AC input voltages, the maximum peak value of inrush current will occur during the first half cycle of the applied AC voltage. This peak value decreases exponentially during subsequent cycles of AC voltage.

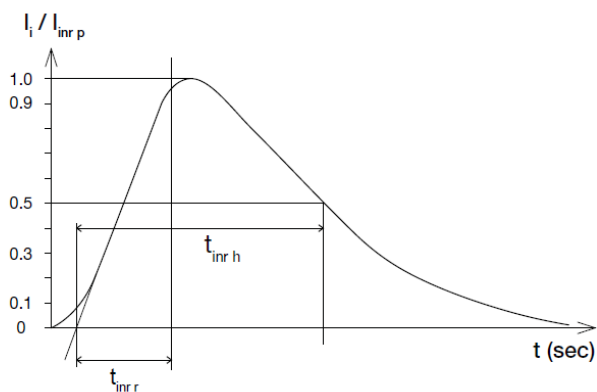

Overvoltage Protection

The power supply's overvoltage circuit will be activated when its internal feedback circuit fails. The output voltage shall not exceed its specifications defined on Page 4 under "Protections". Power supply will latch off, and require removal/re-application of input AC voltage in order to restart.

Short Circuit Protection

The power supply's output OLP/OCP function also provides protection against short circuits. When a short circuit is applied, the output current will operate in "Hiccup mode", as shown in the illustration in the OLP/OCP section on this page. The power supply will return to normal operation after the short circuit is removed.

Overload & Over current Protections

The power supply's Overload (OLP) and Over current (OCP) Protections will be activated when output current is between 110% and 130% of I_o (Max load). Upon such an occurrence, V_o will start to drop. Once the power supply has reached its maximum power limit, the protection will be activated, and the power supply will go into "Hiccup mode" (Auto-Recovery). The power supply will recover once the fault condition causing the OLP and OCP is removed and I_o is back within the specified limit.

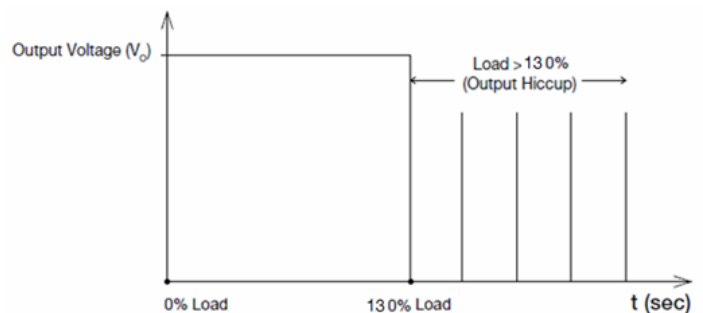

Additionally, if the I_o is $< 130\%$ but $> 110\%$ for a prolonged period of time (depending on the load), the Over Temperature Protection (OTP) will be activated due to high temperature on critical components. The power supply will then go into hiccup mode until the fault is removed; and, the input voltage is removed, then reapplied.

Over Temperature Protection

As mentioned above, the power supply also has Over Temperature Protection (OTP). This is activated when the overload condition persists for an extended duration and the output current is below the overload trigger point but $> 100\%$ load. In the event of a higher operating condition at 100% load, the power supply will run into OTP when the surrounding air temperature is higher than the operating temperature. When activated, the output voltage will go into hiccup mode (latch off mode for MDS-400AUS19 BA) until the input voltage is removed; then, reapplied, and the surrounding air temperature drops to its normal operating temperature.

MDS Medical AC-DC Open Frame

400 W / MDS-400AUS□ BA

Certificate



Delta has been certified as meeting the requirement of ISO 13485: 2003 and EN ISO 13485:2012 for the design and manufacture of switching power supply and adaptor for medical device.



In addition to a UL Total Certification Program (TCP) approved client laboratory for IEC 62368-1. Delta also has participated UL Client Test Data Program (CDTP) for IEC 60601

Attention

Delta provides all information in the datasheets on an "AS IS" basis and does not offer any kind of warranty through the information for using the product. In the event of any discrepancy between the information in the catalog and datasheets, the datasheets shall prevail, (please refer to www.DeltaPSU.com for the latest datasheets information). Delta shall have no liability of indemnification for any claim or action arising from any error for the provided information in the datasheets. Customer shall take its responsibility for evaluation of using the product before placing an order with Delta.

Delta reserves the right to make changes to the information described in the datasheets without notice.

Manufacturer and Authorized Representatives Information

Manufacturer

Thailand

Delta Electronics (Thailand) PCL.
909 Pattana 1 Rd., Muang, Samutprakarn, 10280 Thailand

Taiwan

Delta Electronics, Inc.
3 Tungyuan Road, Chungli Industrial Zone, Taoyuan County
32063, Taiwan

Authorized Representatives

The Netherlands

Delta Greentech (Netherlands) B.V.
Zandsteen 15, 2132 MZ Hoofddorp, The Netherlands

United Kingdom

Delta Electronics Europe Limited
1 Redwood Court, Peel Park Campus,
East Kilbride, Glasgow, G74 5PF, United Kingdom