

LP3869x-ADJ 1-A Low Dropout CMOS Linear Regulator With Adjustable Output - Stable With Ceramic Output Capacitors

1 Features

- Input Voltage Range: 2.7 V to 10 V
- Output Voltage Range: 1.25 V to 9 V
- 2.5% Adjust Pin Voltage Accuracy (25°C)
- Low Dropout Voltage: 450 mV at 1 A (5-V Typical V_{OUT})
- Precision (Trimmed) Bandgap Reference
- Ensured Specs for -40°C to $+125^{\circ}\text{C}$
- 1- μA Off-State Quiescent Current
- Thermal Overload Protection
- Foldback Current Limiting
- Enable (EN) Pin (LP38692-ADJ)
- 5-Pin SOT-223 and 6-Pin WSON Packages

2 Applications

- Hard Disk Drives
- Notebook Computers
- Battery-Powered Devices
- Portable Instrumentation

3 Description

The LP38690-ADJ and LP38692-ADJ low dropout CMOS linear regulators provide 2.5% precision reference voltage, extremely low dropout voltage (450 mV at 1-A load current, $V_{OUT} = 5\text{ V}$) and excellent AC performance utilizing ultralow equivalent series resistance (ESR) ceramic output capacitors.

The low thermal resistance of the WSON and SOT-223 packages allow the full operating current to be used even in high ambient temperature environments.

The use of a PMOS power transistor means that no DC base drive current is required to bias it allowing ground pin current to remain below 100 μA regardless of load current, input voltage, or operating temperature.

- Dropout Voltage: 450 mV (typical) at 1 A (typical 5-V out)
- Ground Pin Current: 55 μA (typical) at full load
- Adjust Pin Voltage: 2.5% (25°C) accuracy

Device Information⁽¹⁾

PART NUMBER	PACKAGE	BODY SIZE (NOM)
LP38690-ADJ	WSON (6)	3.00 mm x 3.00 mm
LP38692-ADJ	SOT-223 (5)	6.50 mm x 3.56 mm

(1) For all available packages, see the orderable addendum at the end of the data sheet.

Simplified Schematic LP38690-ADJ

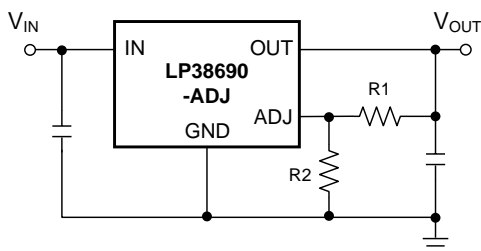

Simplified Schematic LP38692-ADJ

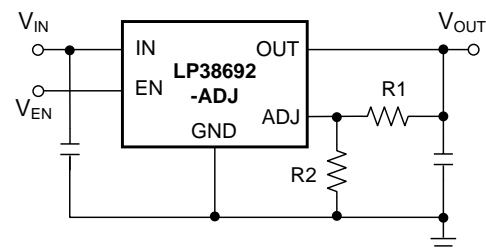

$$V_{OUT} = V_{ADJ} \times (1 + R1/R2)$$



Table of Contents

1 Features	1	8 Application and Implementation	13
2 Applications	1	8.1 Application Information.....	13
3 Description	1	8.2 Typical Application	14
4 Revision History	2	9 Power Supply Recommendations	17
5 Pin Configuration and Functions	3	10 Layout	17
6 Specifications	4	10.1 Layout Guidelines	17
6.1 Absolute Maximum Ratings	4	10.2 Layout Examples.....	18
6.2 ESD Ratings.....	4	10.3 WSON Mounting	18
6.3 Recommended Operating Conditions.....	4	11 Device and Documentation Support	19
6.4 Thermal Information	4	11.1 Device Support.....	19
6.5 Electrical Characteristics.....	5	11.2 Documentation Support	19
6.6 Typical Characteristics	6	11.3 Related Links	19
7 Detailed Description	11	11.4 Community Resources.....	19
7.1 Overview	11	11.5 Trademarks	19
7.2 Functional Block Diagrams	11	11.6 Electrostatic Discharge Caution.....	19
7.3 Feature Description.....	12	11.7 Glossary	19
7.4 Device Functional Modes.....	12	12 Mechanical, Packaging, and Orderable Information	20

4 Revision History

NOTE: Page numbers for previous revisions may differ from page numbers in the current version.

Changes from Revision H (April 2013) to Revision I	Page
• Added top navigator icon for TI Design	1
• Added <i>Device Information</i> and <i>Pin Configuration and Functions</i> sections, <i>ESD Ratings</i> and <i>Thermal Information</i> tables, <i>Feature Description</i> , <i>Device Functional Modes</i> , <i>Application and Implementation</i> , <i>Power Supply Recommendations</i> , <i>Layout</i> , <i>Device and Documentation Support</i> , and <i>Mechanical, Packaging, and Orderable Information</i> sections.....	1
• Changed pin names from "Vin", "Vout" and "Ven" to "IN", "OUT", and "EN"	1
• Changed language of note 3 to Abs Max table	4
• Added Caution note to <i>Foldback Current Limiting</i> subsection	12
• Deleted paragraph beginning "For the LP38690-ADJ and LP38692-ADJ in the NGG0006A 6-Lead WSON package..." and table following - information out of date.....	18

Changes from Revision G (December 2010) to Revision H	Page
• Changed layout of National Data Sheet to TI format	16

5 Pin Configuration and Functions

**NDC Package (LP38692-ADJ only)
5-Pin SOT-223
Top View**

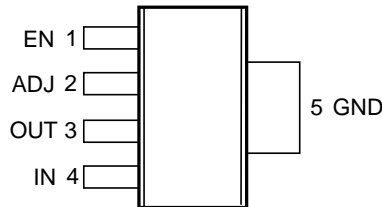

**NGG Package (LP38690-ADJ)
6-Pin WSON
Top View**

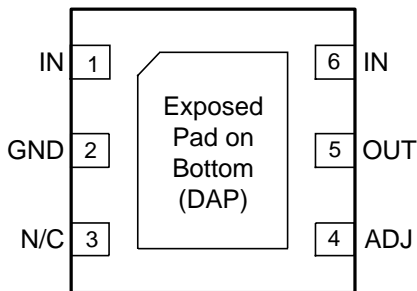

**NGG Package (LP38692-ADJ)
6-Pin WSON
Top View**

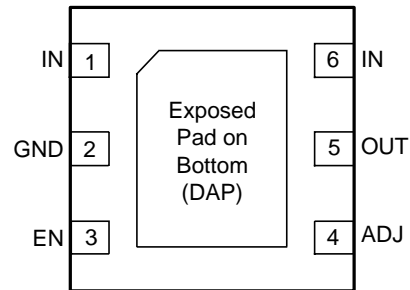

Pin Functions

	PIN			I/O	DESCRIPTION
	LP38690-ADJ	LP38692-ADJ			
NAME	WSON	WSON	SOT-223		
ADJ	4	4	2	O	The ADJ pin is used to set the regulated output voltage by connecting it to the external resistors R1 and R2 (see Simplified Schematic LP38690-ADJ and Simplified Schematic LP38692-ADJ).
DAP	√	√	—	—	WSON only - The DAP (exposed pad) functions as a thermal connection when soldered to a copper plane. See Layout Guidelines for more information.
EN ⁽¹⁾	—	3	1	I	The EN pin allows the part to be turned to an ON or OFF state by pulling this pin high or low.
GND	2	2	5	—	Circuit ground for the regulator. For the SOT-223 package this is thermally connected to the die and functions as a heat sink when the soldered down to a large copper plane.
IN	1, 6	1, 6	4	I	This is the input supply voltage to the regulator. For WSON devices, both IN pins must be tied together for full current operation (250 mA maximum per pin).
NC ⁽²⁾	3	—	—	—	No internal connection.
OUT	5	5	3	I	Regulated output voltage.

(1) The EN pin is only available on the LP38692-ADJ.

(2) Pin 3 on the LP38690-ADJ is not used.

6 Specifications

6.1 Absolute Maximum Ratings

see ⁽¹⁾⁽²⁾

	MIN	MAX	UNIT
All pins (with respect to GND), V_{MAX}	-0.3	12	V
$I_{OUT}^{(3)}$	Internally Limited		
Power dissipation ⁽⁴⁾	Internally Limited		
Junction temperature	-40	150	°C
Storage temperature, T_{stg}	-65	150	°C

- (1) Stresses beyond those listed under *Absolute Maximum Ratings* may cause permanent damage to the device. These are stress ratings only, which do not imply functional operation of the device at these or any other conditions beyond those indicated under *Recommended Operating Conditions*. Exposure to absolute-maximum-rated conditions for extended periods may affect device reliability.
- (2) If Military/Aerospace specified devices are required, contact the TI Sales Office/ Distributors for availability and specifications.
- (3) If used in a dual-supply system where the regulator load is returned to a negative supply, the output pin must be diode clamped to ground.
- (4) At elevated temperatures, device power dissipation must be derated based on package thermal resistance and heatsink values (if a heatsink is used). When using the WSON package, refer to *Leadless Leadframe Package (LLP) (SNOA401)* and the *WSON Mounting* section in this datasheet. If power dissipation causes the junction temperature to exceed specified limits, the device goes into thermal shutdown.

6.2 ESD Ratings

	VALUE	UNIT
V_{ESD} Electrostatic discharge Human-body model (HBM), per ANSI/ESDA/JEDEC JS-001 ⁽¹⁾	2000	V

- (1) JEDEC document JEP155 states that 500-V HBM allows safe manufacturing with a standard ESD control process.

6.3 Recommended Operating Conditions

	MIN	MAX	UNIT
Supply voltage, V_{IN}	2.7	10	V
Operating junction temperature, T_J	-40	125	°C

6.4 Thermal Information

THERMAL METRIC ⁽¹⁾	LP38692-ADJ	LP3869x-ADJ	UNIT
	NDC (SOT-223)	NGG (WSON)	
	5 PINS	6 PINS	
$R_{\theta JA}^{(2)}$ Junction-to-ambient thermal resistance, High-K	68.5	50.6 ⁽³⁾	°C/W
$R_{\theta JC(top)}$ Junction-to-case (top) thermal resistance	52.2	44.4	°C/W
$R_{\theta JB}$ Junction-to-board thermal resistance	13.0	24.9	°C/W
Ψ_{JT} Junction-to-top characterization parameter	5.5	0.4	°C/W
Ψ_{JB} Junction-to-board characterization parameter	12.8	25.1	°C/W
$R_{\theta JC(bot)}$ Junction-to-case (bottom) thermal resistance	n/a	5.4	°C/W

- (1) For more information about traditional and new thermal metrics, see the *Semiconductor and IC Package Thermal Metrics* application report, [SPRA953](#).
- (2) Thermal resistance value $R_{\theta JA}$ is based on EIA/JEDEC High-K printed circuit board defined by: JESD51-7 - *High Effective Thermal Conductivity Test Board for Leaded Surface Mount Packages*.
- (3) The PCB for the WSON (NGG) package $R_{\theta JA}$ includes four (4) thermal vias under the exposed thermal pad per EIA/JEDEC JESD51-5.

6.5 Electrical Characteristics

Unless otherwise specified: typical limits are for $T_J = 25^\circ\text{C}$, minimum and maximum limits apply over the full operating temperature range; $V_{IN} = V_{OUT} + 1\text{ V}$, $C_{IN} = C_{OUT} = 10\ \mu\text{F}$, $I_{LOAD} = 10\ \text{mA}$. Minimum and maximum limits are specified through testing, statistical correlation, or design.

PARAMETER		TEST CONDITIONS	MIN	TYP ⁽¹⁾	MAX	UNIT
V_{ADJ}	ADJ pin voltage	$V_{IN} = 2.7\text{ V}$, $T_J = 25^\circ\text{C}$	1.219	1.25	1.281	V
		$3.2\text{ V} \leq V_{IN} \leq 10\text{ V}$ $100\ \mu\text{A} < I_{LOAD} < 1\text{ A}$	1.187	1.25	1.313	
$\Delta V_{OUT}/\Delta V_{IN}$	Output voltage line regulation ⁽²⁾	$V_{OUT} + 0.5\text{ V} \leq V_{IN} \leq 10\text{ V}$ $I_{LOAD} = 25\text{ mA}$		0.03	0.1	%/V
$\Delta V_{OUT}/\Delta I_{LOAD}$	Output voltage load regulation ⁽³⁾	$1\text{ mA} < I_{LOAD} < 1\text{ A}$ $V_{IN} = V_{OUT} + 1\text{ V}$		1.8	5	%/A
$V_{IN} - V_{OUT}$	Dropout voltage ⁽⁴⁾	$V_{OUT} = 1.8\text{ V}$, $I_{LOAD} = 1\text{ A}$		950	1600	mV
		$V_{OUT} = 2.5\text{ V}$, $I_{LOAD} = 0.1\text{ A}$		80	145	
		$V_{OUT} = 2.5\text{ V}$, $I_{LOAD} = 1\text{ A}$		800	1300	
		$V_{OUT} = 3.3\text{ V}$, $I_{LOAD} = 0.1\text{ A}$		65	110	
		$V_{OUT} = 3.3\text{ V}$, $I_{LOAD} = 1\text{ A}$		650	1000	
		$V_{OUT} = 5\text{ V}$, $I_{LOAD} = 0.1\text{ A}$		45	100	
		$V_{OUT} = 5\text{ V}$, $I_{LOAD} = 1\text{ A}$		450	800	
I_Q	Quiescent current	$V_{IN} \leq 10\text{ V}$, $I_{LOAD} = 100\ \mu\text{A} - 1\text{ A}$		55	100	μA
		$V_{EN} \leq 0.4\text{ V}$, $T_J = 25^\circ\text{C}$ (LP38692-ADJ Only)		0.001	1	
$I_L(\text{MIN})$	Minimum load current	$V_{IN} - V_{OUT} \leq 4\text{ V}$			100	μA
I_{FB}	Foldback current limit	$V_{IN} - V_{OUT} > 5\text{ V}$		450		mA
		$V_{IN} - V_{OUT} < 4\text{ V}$		1500		
PSRR	Ripple rejection	$V_{IN} = V_{OUT} + 2\text{ V}_{(\text{DC})}$, with $1\text{ V}_{(\text{p-p})} / 120\text{-Hz}$ ripple		55		dB
T_{SD}	Thermal shutdown activation (junction temperature)			160		$^\circ\text{C}$
$T_{SD}(\text{HYST})$	Thermal shutdown hysteresis (junction temperature)			10		$^\circ\text{C}$
I_{ADJ}	ADJ input leakage current	$V_{ADJ} = 0 - 1.5\text{ V}$ $V_{IN} = 10\text{ V}$, $T_J = 25^\circ\text{C}$	-100	0.01	100	nA
e_n	Output noise	BW = 10 Hz to 10 kHz $V_{OUT} = 3.3\text{ V}$		0.7		$\mu\text{V}/\sqrt{\text{Hz}}$
$V_{OUT}(\text{LEAK})$	Output leakage current	$V_{OUT} = V_{OUT(\text{NOM})} + 1\text{ V}$ at 10 V_{IN} $T_J = 25^\circ\text{C}$		0.5	2	μA
V_{EN}	Enable voltage (LP38692-ADJ Only)	Output = OFF			0.4	V
		Output = ON, $V_{IN} = 4\text{ V}$	1.8			
		Output = ON, $V_{IN} = 6\text{ V}$	3			
		Output = ON, $V_{IN} = 10\text{ V}$	4			
I_{EN}	Enable pin leakage (LP38692-ADJ Only)	$V_{EN} = 0\text{ V}$ or 10 V , $V_{IN} = 10\text{ V}$ $T_J = 25^\circ\text{C}$	-1	0.001	1	μA

(1) Typical numbers represent the most likely parametric norm for 25°C operation.

(2) Output voltage line regulation is defined as the change in output voltage from nominal value resulting from a change in input voltage.

(3) Output voltage load regulation is defined as the change in output voltage from nominal value as the load current increases from 1 mA to full load.

(4) Dropout voltage is defined as the minimum input to output differential required to maintain the output within 100 mV of nominal value.

6.6 Typical Characteristics

Unless otherwise specified: $T_J = 25^\circ\text{C}$, $C_{IN} = C_{OUT} = 10\ \mu\text{F}$, EN pin is tied to V_{IN} (LP38692-ADJ only), $V_{OUT} = 1.25\ \text{V}$, $V_{IN} = 2.7\ \text{V}$, $I_{LOAD} = 10\ \text{mA}$.

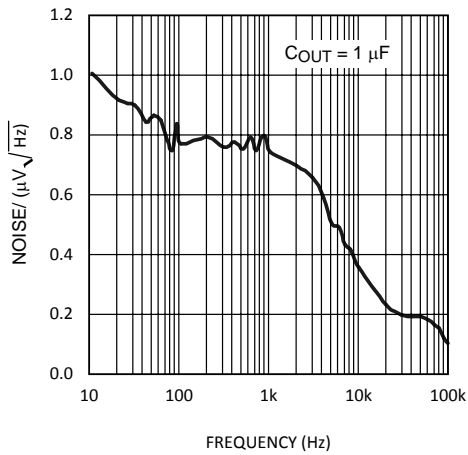

Figure 1. Noise vs Frequency

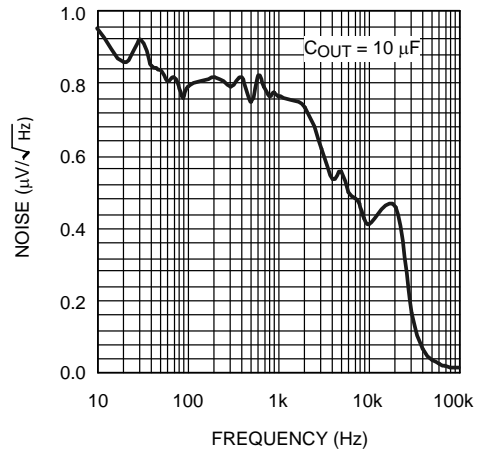

Figure 2. Noise vs Frequency

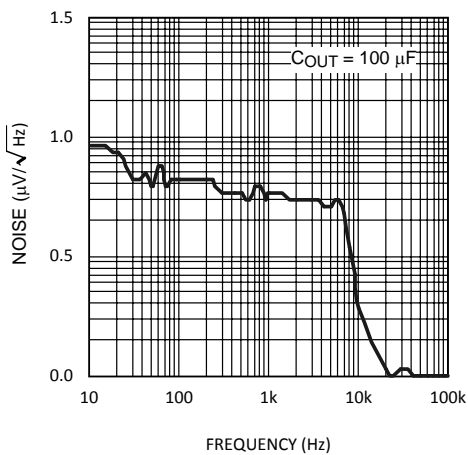

Figure 3. Noise vs Frequency

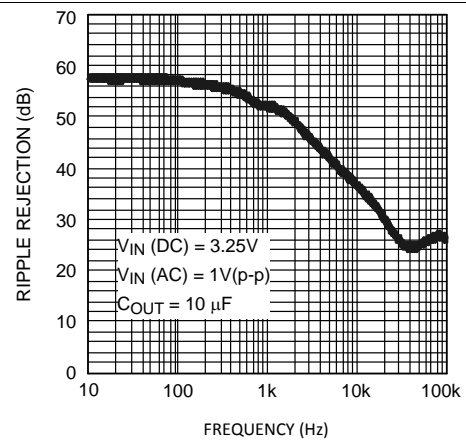

Figure 4. Ripple Rejection

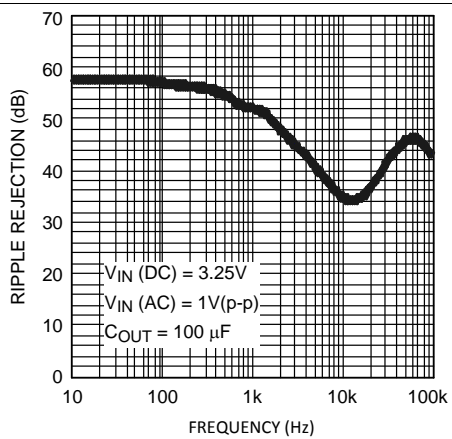

Figure 5. Ripple Rejection

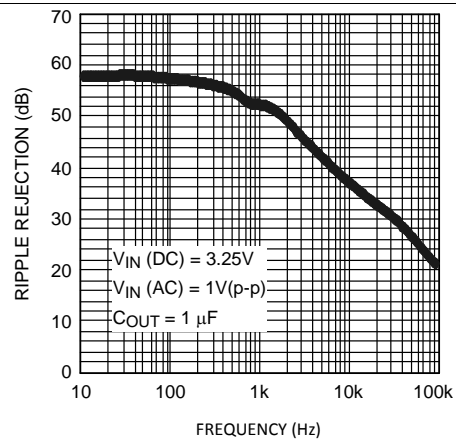

Figure 6. Ripple Rejection

Typical Characteristics (continued)

Unless otherwise specified: $T_J = 25^\circ\text{C}$, $C_{IN} = C_{OUT} = 10\ \mu\text{F}$, EN pin is tied to V_{IN} (LP38692-ADJ only), $V_{OUT} = 1.25\ \text{V}$, $V_{IN} = 2.7\ \text{V}$, $I_{LOAD} = 10\ \text{mA}$.

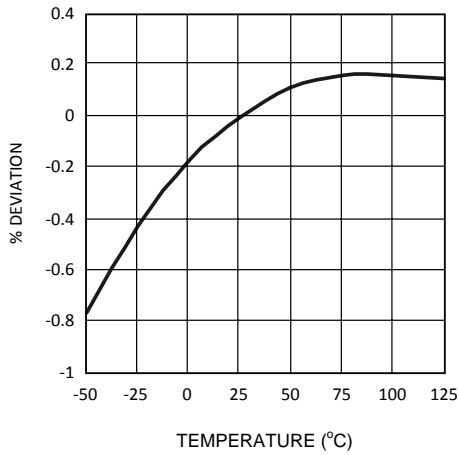

Figure 7. V_{ADJ} vs Temperature

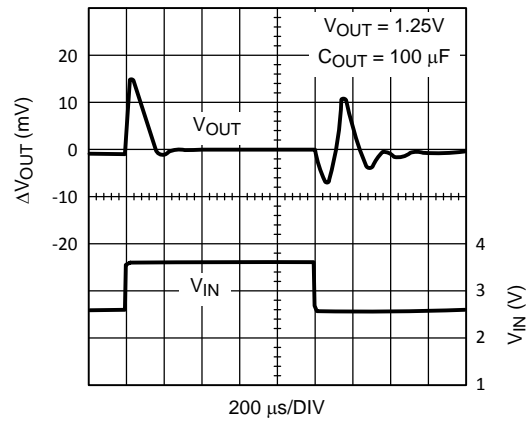

Figure 8. Line Transient Response

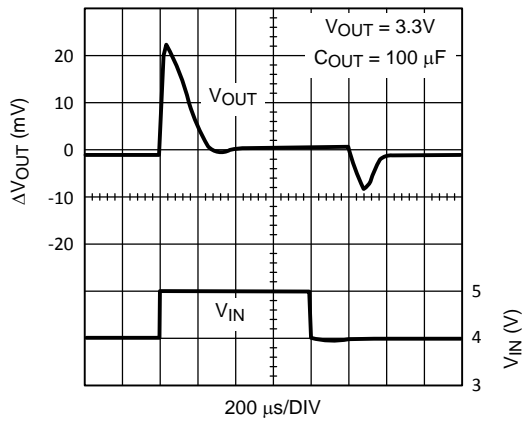

Figure 9. Line Transient Response

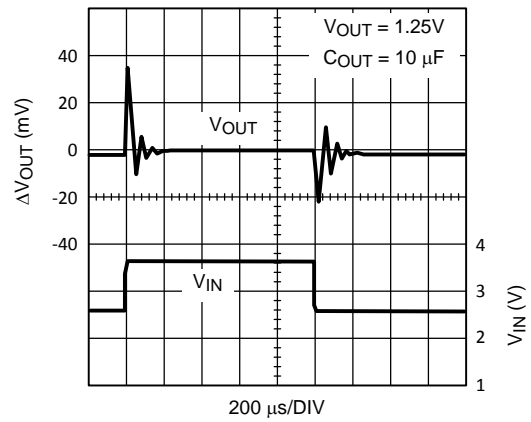

Figure 10. Line Transient Response

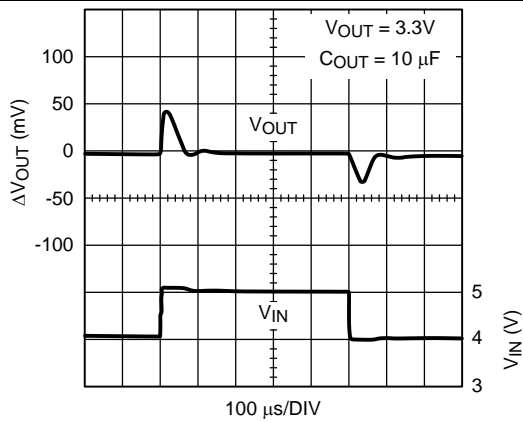

Figure 11. Line Transient Response

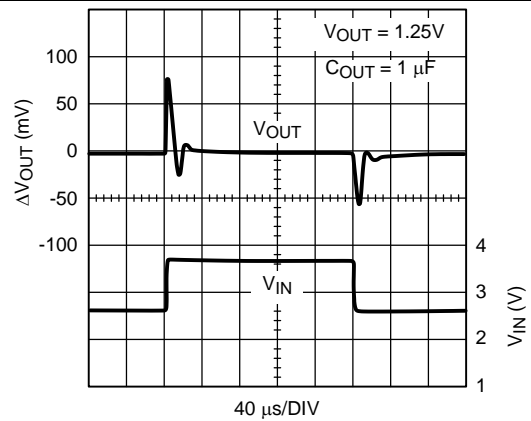
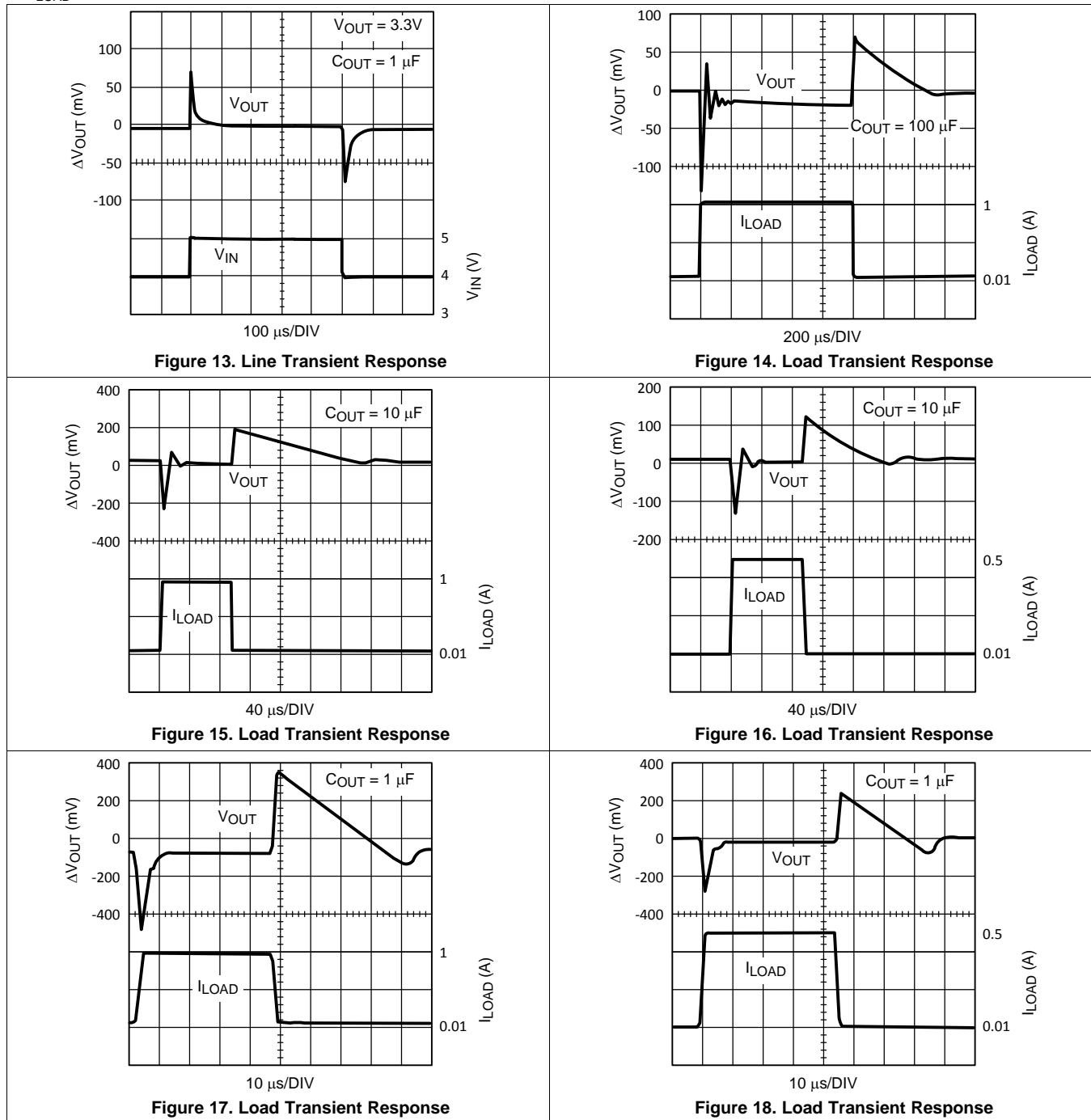

Figure 12. Line Transient Response

Typical Characteristics (continued)

Unless otherwise specified: $T_J = 25^\circ\text{C}$, $C_{IN} = C_{OUT} = 10\ \mu\text{F}$, EN pin is tied to V_{IN} (LP38692-ADJ only), $V_{OUT} = 1.25\ \text{V}$, $V_{IN} = 2.7\ \text{V}$, $I_{LOAD} = 10\ \text{mA}$.



Typical Characteristics (continued)

Unless otherwise specified: $T_J = 25^\circ\text{C}$, $C_{IN} = C_{OUT} = 10\ \mu\text{F}$, EN pin is tied to V_{IN} (LP38692-ADJ only), $V_{OUT} = 1.25\ \text{V}$, $V_{IN} = 2.7\ \text{V}$, $I_{LOAD} = 10\ \text{mA}$.

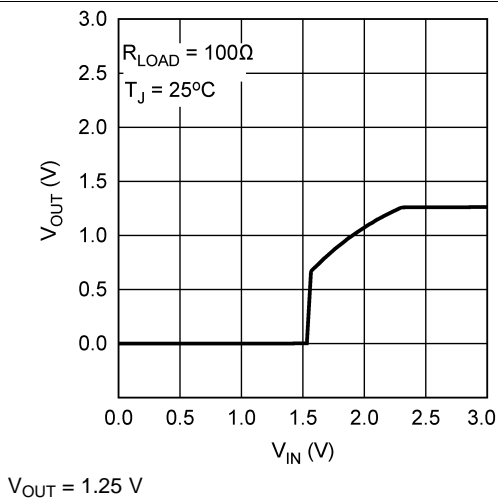

Figure 19. V_{OUT} vs V_{IN}

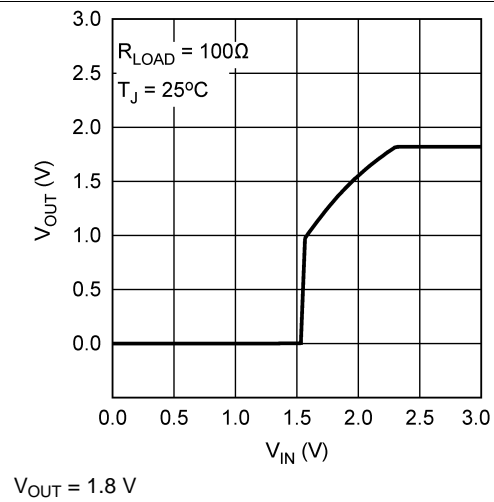

Figure 20. V_{OUT} vs V_{IN}

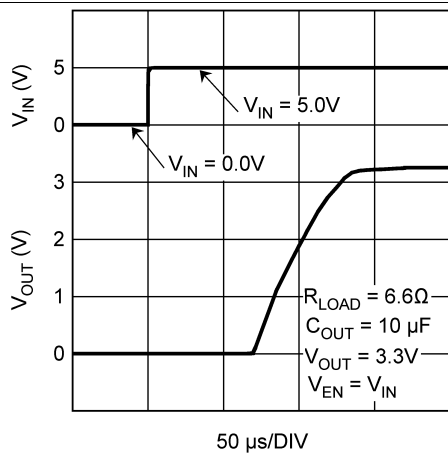

Figure 21. V_{OUT} vs V_{IN} (Power-Up)

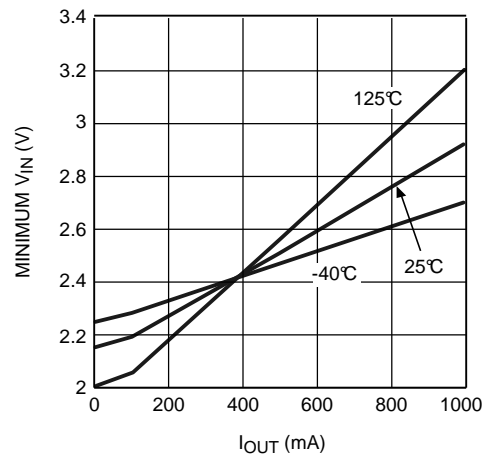

Figure 22. Minimum V_{IN} vs I_{OUT}

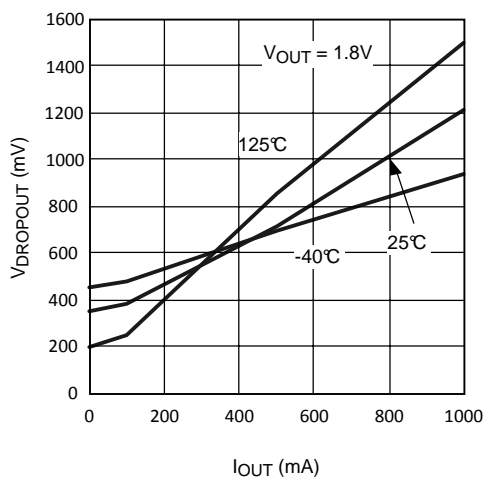

Figure 23. Dropout Voltage vs I_{OUT}

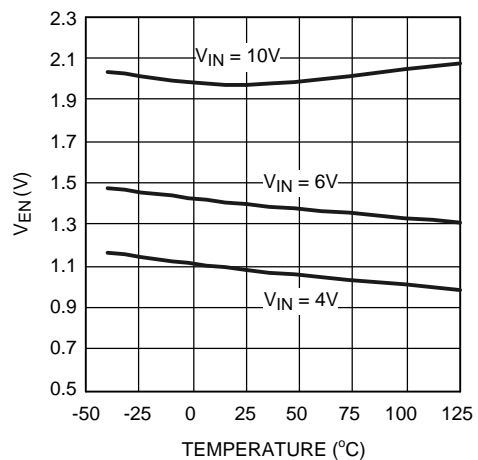

Figure 24. Enable Voltage vs Temperature

Typical Characteristics (continued)

Unless otherwise specified: $T_J = 25^\circ\text{C}$, $C_{IN} = C_{OUT} = 10\ \mu\text{F}$, EN pin is tied to V_{IN} (LP38692-ADJ only), $V_{OUT} = 1.25\ \text{V}$, $V_{IN} = 2.7\ \text{V}$, $I_{LOAD} = 10\ \text{mA}$.

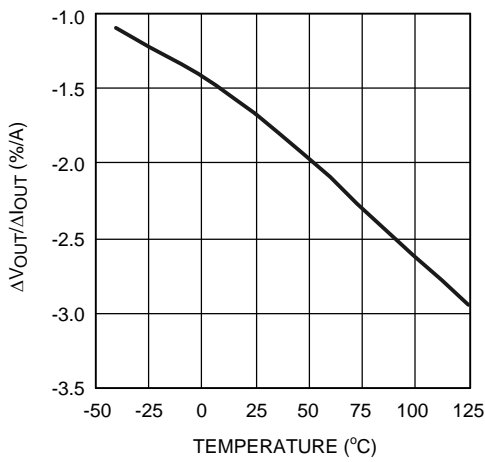

Figure 25. Load Regulation vs Temperature

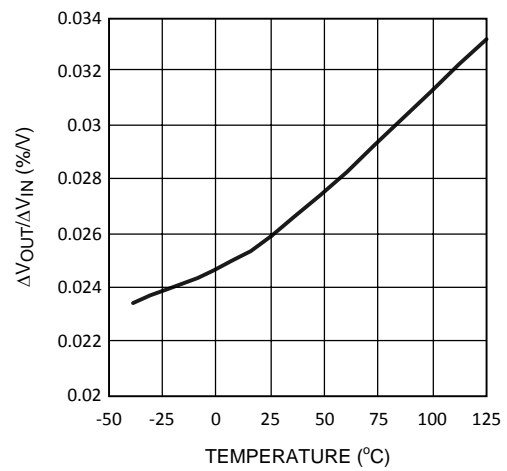

Figure 26. Line Regulation vs Temperature

7 Detailed Description

7.1 Overview

The LP3869x-ADJ devices are designed to meet the requirements of portable, battery-powered digital systems providing an accurate output voltage with fast start-up. When disabled via a low logic signal at the enable pin (EN), the power consumption is reduced to virtually zero (LP38692-ADJ only). The LP3869x devices perform well with a single 1- μ F input capacitor and a single 1- μ F ceramic output capacitor.

7.2 Functional Block Diagrams

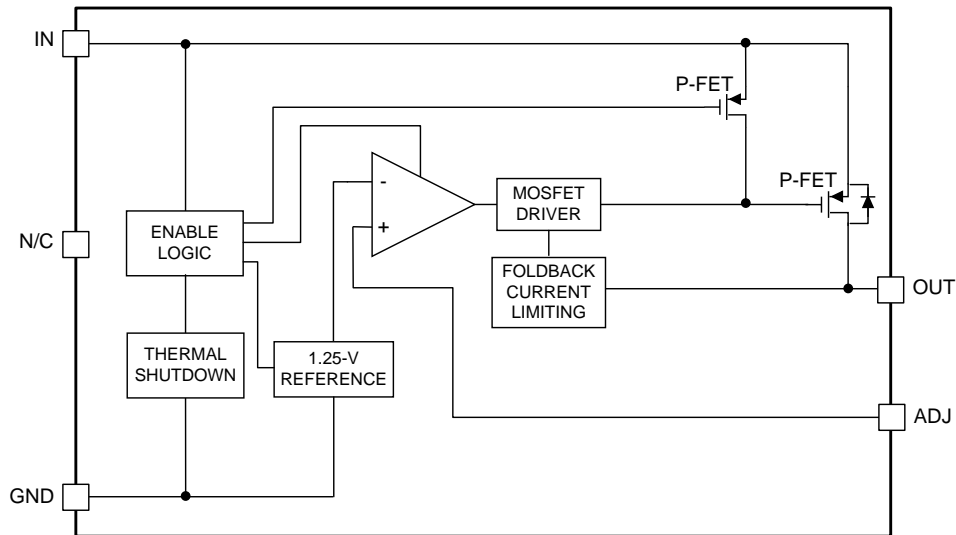

Figure 27. LP38690-ADJ (WSO)

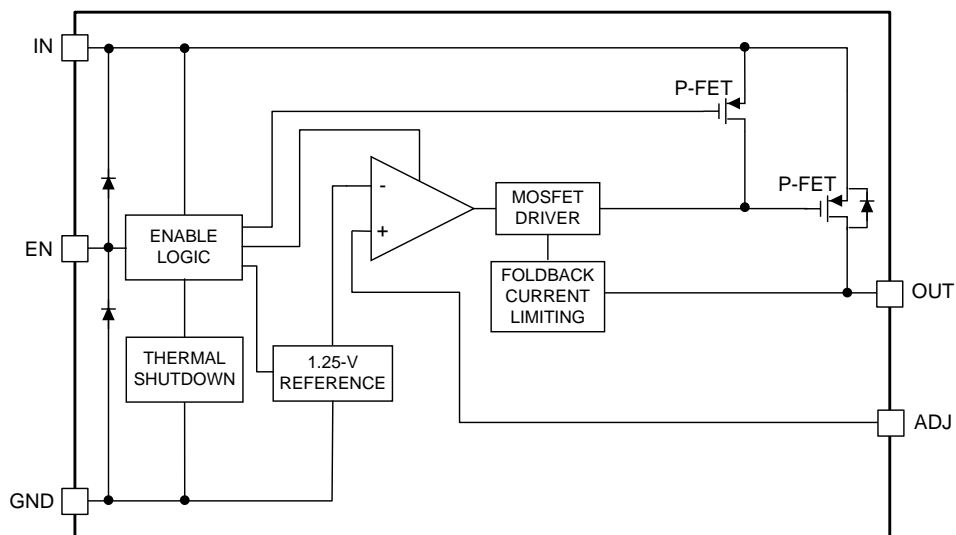

Figure 28. LP38692-ADJ (SOT-223, WSO)

7.3 Feature Description

7.3.1 Foldback Current Limiting

Foldback current limiting is built into the LP3869x-ADJ which reduces the amount of output current the part can deliver as the output voltage is reduced. The amount of load current is dependent on the differential voltage between V_{IN} and V_{OUT} . Typically, when this differential voltage exceeds 5 V, the load current will limit at about 450 mA. When the $V_{IN} - V_{OUT}$ differential is reduced below 4 V, load current is limited to about 1500 mA.

CAUTION

When toggling the LP38692 EN pin after the input voltage (V_{IN}) is applied, the foldback current limit circuitry is functional the first time that the EN pin is taken high. The foldback current limit circuitry is non-functional the second, and subsequent, times that the EN pin is taken high. Depending on the input and output capacitance values the input inrush current may be higher than expected which can cause the input voltage to droop.

If the EN pin is connected to the IN pin, the foldback current limit circuitry is functional when V_{IN} is applied if V_{IN} starts from less than 0.4 V.

7.4 Device Functional Modes

7.4.1 Enable Pin (LP38692-ADJ Only)

The LP38692-ADJ has an enable pin (EN) which allows an external control signal to turn the regulator output on and off. The enable on/off threshold has no hysteresis. The voltage signal must rise and fall cleanly, and promptly, through the on and off voltage thresholds. The EN pin has no internal pull-up or pull-down to establish a default condition and, as a result, this pin must be terminated either actively or passively. If the EN pin is driven from a source that actively pulls high and low, the drive voltage must not be allowed to go below ground potential or higher than V_{IN} . If the application does not require the enable function, the pin must be connected directly to the IN pin.

8 Application and Implementation

NOTE

Information in the following applications sections is not part of the TI component specification, and TI does not warrant its accuracy or completeness. TI's customers are responsible for determining suitability of components for their purposes. Customers should validate and test their design implementation to confirm system functionality.

8.1 Application Information

8.1.1 Reverse Voltage

A reverse voltage condition exists when the voltage at the OUT pin is higher than the voltage at the IN pin. Typically this happens when IN is abruptly taken low and C_{OUT} continues to hold a sufficient charge such that the input-to-output voltage becomes reversed. A less-common condition is when an alternate voltage source is connected to the output.

There are two possible paths for current to flow from the OUT pin back to the input during a reverse voltage condition.

1. While V_{IN} is high enough to keep the control circuitry alive, and the EN pin (LP38692-ADJ only) is above the $V_{EN(ON)}$ threshold, the control circuitry will attempt to regulate the output voltage. If the input voltage is less than the programmed output voltage, the control circuit drives the gate of the pass element to the full ON condition. In this condition, reverse current flows from the OUT pin to the IN pin, limited only by the $R_{DS(ON)}$ of the pass element and the output to input voltage differential. Discharging an output capacitor up to 1000 μ F in this manner does not damage the device as the current rapidly decays. However, continuous reverse current must be avoided. When the EN pin is low this condition is prevented.
2. The internal PFET pass element has an inherent parasitic diode. During normal operation, the input voltage is higher than the output voltage and the parasitic diode is reverse biased. However, when V_{IN} is below the value where the control circuitry is alive, or the EN pin is low (LP38692-ADJ only), and the output voltage is more than 500 mV (typical) above the input voltage the parasitic diode becomes forward biased and current flows from the OUT pin to the IN pin through the diode. The current in the parasitic diode must be limited to less than 1-A continuous and 5-A peak.

If used in a dual-supply system where the regulator output load is returned to a negative supply, the OUT pin must be diode clamped to ground to limit the negative voltage transition. A Schottky diode is recommended for this protective clamp.

8.2 Typical Application

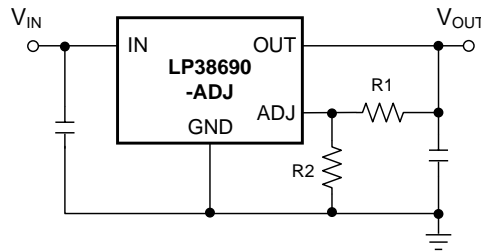
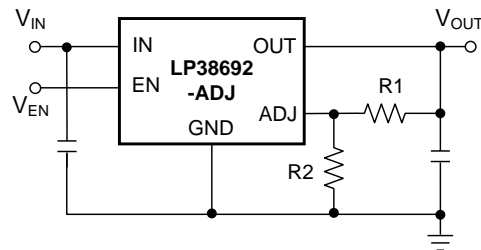

Figure 29. LP38690-ADJ Typical Application



$$V_{OUT} = V_{ADJ} \times (1 + R1/R2)$$

Figure 30. LP38692-ADJ Typical Application

8.2.1 Design Requirements

For typical CMOS voltage regulator applications, use the parameters listed in [Table 1](#)

Table 1. Design Parameters

DESIGN PARAMETER	EXAMPLE VALUE
Minimum input voltage	2.7 V
Minimum output voltage	1.25 V
Output current	150 mA
Input and output capacitors	1 μ F
Input/output capacitor ESR range	0 m Ω to 100 m Ω

8.2.2 Detailed Design Procedure

8.2.2.1 Setting The Output Voltage

The output voltage is set using the external resistors R1 and R2 (see [Figure 29](#) and [Figure 30](#)). The output voltage is given by [Equation 1](#):

$$V_{OUT} = V_{ADJ} \times (1 + (R1 / R2)) \quad (1)$$

Because the part has a minimum load current requirement of 100 μ A, TI recommends that R2 always be 12 k Ω or less to provide adequate loading. Even if a minimum load is always provided by other means, it is not recommended that very high value resistors be used for R1 and R2 because it can make the ADJ node susceptible to noise pickup. A maximum value of 100 k Ω is recommended for R2 to prevent this from occurring.

8.2.2.2 External Capacitors

Like any low-dropout regulator, external capacitors are required to assure stability. These capacitors must be correctly selected for proper performance.

8.2.2.2.1 Input Capacitor

An input capacitor of at least 1 μ F is required (ceramic recommended). The capacitor must be located not more than one centimeter from the IN pin and returned to a clean analog ground.

8.2.2.2.2 Output Capacitor

An output capacitor is required for loop stability. It must be located less than 1 centimeter from the device and connected directly to the OUT and GND pins using traces which have no other currents flowing through them.

The minimum amount of output capacitance that can be used for stable operation is 1 μF . Ceramic capacitors are recommended (the LP3869x-ADJ was designed for use with ultralow-ESR capacitors). The LP3869x-ADJ is stable with any output capacitor ESR between 0 Ω and 100 Ω .

8.2.2.2.3 Selecting A Capacitor

It is important to note that capacitance tolerance and variation with temperature must be taken into consideration when selecting a capacitor so that the minimum required amount of capacitance is provided over the full operating temperature range.

8.2.2.2.3.1 Ceramic

For values of capacitance in the 10- μF to 100- μF range, ceramics are usually larger and more costly than tantalum capacitors but give superior AC performance for bypassing high frequency noise because of very low ESR (typically less than 10 m Ω). However, some dielectric types do not have good capacitance characteristics as a function of voltage and temperature.

Z5U and Y5V dielectric ceramics have capacitance that drops severely with applied voltage. A typical Z5U or Y5V capacitor can lose 60% of its rated capacitance with half of the rated voltage applied to it. The Z5U and Y5V also exhibit a severe temperature effect, losing more than 50% of nominal capacitance at high and low limits of the temperature range.

X7R and X5R dielectric ceramic capacitors are strongly recommended if ceramics are used, as they typically maintain a capacitance range within $\pm 20\%$ of nominal over full operating ratings of temperature and voltage. They are typically larger and more costly than Z5U/Y5U types for a given voltage and capacitance.

8.2.2.2.3.2 Tantalum

Solid tantalum capacitors have good temperature stability: a high-quality tantalum typically show a capacitance value that varies less than 10-15% across the full temperature range of -40°C to $+125^{\circ}\text{C}$. ESR varies only about 2 \times going from the high-to-low temperature limits.

The increasing ESR at lower temperatures can cause oscillations when marginal quality capacitors are used (if the ESR of the capacitor is near the upper limit of the stability range at room temperature).

8.2.2.3 RFI/EMI Susceptibility

Radio frequency interference (RFI) and electromagnetic interference (EMI) can degrade any integrated circuit's performance because of the small dimensions of the geometries inside the device. In applications where circuit sources are present which generate signals with significant high frequency energy content (> 1 MHz), care must be taken to ensure that this does not affect the device regulator.

If RFI/EMI noise is present on the input side of the regulator (such as applications where the input source comes from the output of a switching regulator), good ceramic bypass capacitors must be used at the IN pin of the device.

If a load is connected to the device output which switches at high speed (such as a clock), the high-frequency current pulses required by the load must be supplied by the capacitors on the device output. Since the bandwidth of the regulator loop is less than 100 kHz, the control circuitry cannot respond to load changes above that frequency. This means the effective output impedance of the device at frequencies above 100 kHz is determined only by the output capacitors.

In applications where the load is switching at high speed, the output of the device may need RF isolation from the load. It is recommended that some inductance be placed between the output capacitor and the load, and good RF bypass capacitors be placed directly across the load.

PCB layout is also critical in high noise environments, since RFI/EMI is easily radiated directly into PC traces. Noisy circuitry should be isolated from *clean* circuits where possible, and grounded through a separate path. At MHz frequencies, ground planes begin to look inductive and RFI/EMI can cause ground bounce across the ground plane. In multi-layer PCB applications, care should be taken in layout so that noisy power and ground planes do not radiate directly into adjacent layers which carry analog power and ground.

8.2.2.4 Output Noise

Noise is specified in two ways: *Spot Noise* or *Output Noise Density* is the RMS sum of all noise sources, measured at the regulator output, at a specific frequency (measured with a 1-Hz bandwidth). This type of noise is usually plotted on a curve as a function of frequency. *Total Output Noise* or *Broad-Band Noise* is the RMS sum of spot noise over a specified bandwidth, usually several decades of frequencies.

Attention must be given to the units of measurement. Spot noise is measured in units $\mu\text{V}/\sqrt{\text{Hz}}$ or $\text{nV}/\sqrt{\text{Hz}}$ and total output noise is measured in μV_{RMS} .

The primary source of noise in low-dropout regulators is the internal reference. Noise can be reduced in two ways: by increasing the transistor area or by increasing the current drawn by the internal reference. Increasing the area decreases the chance of fitting the die into a smaller package. Increasing the current drawn by the internal reference increases the total supply current (GND pin current).

8.2.2.5 Power Dissipation

Knowing the device power dissipation and proper sizing of the thermal plane connected to the tab or pad is critical to ensuring reliable operation. Device power dissipation depends on input voltage, output voltage, and load conditions and can be calculated with [Equation 2](#).

$$P_{\text{D(MAX)}} = (V_{\text{IN(MAX)}} - V_{\text{OUT}}) \times I_{\text{OUT}} \quad (2)$$

Power dissipation can be minimized, and greater efficiency can be achieved, by using the lowest available voltage drop option that would still be greater than the dropout voltage (V_{DO}). However, keep in mind that higher voltage drops result in better dynamic (that is, PSRR and transient) performance.

On the WSON (NGD) package, the primary conduction path for heat is through the exposed power pad to the PCB. To ensure the device does not overheat, connect the exposed pad, through thermal vias, to an internal ground plane with an appropriate amount of copper PCB area.

On the SOT-223 (NDC) package, the primary conduction path for heat is through the pins to the PCB.

Power dissipation and junction temperature are most often related by the junction-to-ambient thermal resistance ($R_{\theta\text{JA}}$) of the combined PCB and device package and the temperature of the ambient air (T_{A}), according to [Equation 3](#) or [Equation 4](#):

$$T_{\text{J(MAX)}} = T_{\text{A(MAX)}} + (R_{\theta\text{JA}} \times P_{\text{D(MAX)}}) \quad (3)$$

$$P_{\text{D}} = (T_{\text{J(MAX)}} - T_{\text{A(MAX)}}) / R_{\theta\text{JA}} \quad (4)$$

Unfortunately, this $R_{\theta\text{JA}}$ is highly dependent on the heat-spreading capability of the particular PCB design, and therefore varies according to the total copper area, copper weight, and location of the planes. The $R_{\theta\text{JA}}$ recorded in [Thermal Information](#) is determined by the specific EIA/JEDEC JESD51-7 standard for PCB and copper-spreading area, and is to be used only as a relative measure of package thermal performance. For a well-designed thermal layout, $R_{\theta\text{JA}}$ is actually the sum of the package junction-to-case (bottom) thermal resistance ($R_{\theta\text{JC(bot)}}$) plus the thermal resistance contribution by the PCB copper area acting as a heat sink.

8.2.2.6 Estimating Junction Temperature

The EIA/JEDEC standard recommends the use of psi (Ψ) thermal characteristics to estimate the junction temperatures of surface mount devices on a typical PCB board application. These characteristics are not true thermal resistance values, but rather package specific thermal characteristics that offer practical and relative means of estimating junction temperatures. These psi metrics are determined to be significantly independent of copper-spreading area. The key thermal characteristics (Ψ_{JT} and Ψ_{JB}) are given in [Thermal Information](#) and are used in accordance with [Equation 5](#) or [Equation 6](#).

$$T_{\text{J(MAX)}} = T_{\text{TOP}} + (\Psi_{\text{JT}} \times P_{\text{D(MAX)}})$$

where

- $P_{\text{D(MAX)}}$ is explained in [Equation 4](#)
- T_{TOP} is the temperature measured at the center-top of the device package. (5)

$$T_{\text{J(MAX)}} = T_{\text{BOARD}} + (\Psi_{\text{JB}} \times P_{\text{D(MAX)}})$$

where

- $P_{\text{D(MAX)}}$ is explained in [Equation 4](#).
- T_{BOARD} is the PCB surface temperature measured 1-mm from the device package and centered on the package edge. (6)

For more information about the thermal characteristics Ψ_{JT} and Ψ_{JB} , see *Semiconductor and IC Package Thermal Metrics (SPRA953)*; for more information about measuring T_{TOP} and T_{BOARD} , see the *Using New Thermal Metrics (SBVA025)*; and for more information about the EIA/JEDEC JESD51 PCB used for validating $R_{\theta JA}$, see the *Thermal Characteristics of Linear and Logic Packages Using JEDEC PCB Designs (SZZA017)*. These application notes are available at www.ti.com.

8.2.3 Application Curves

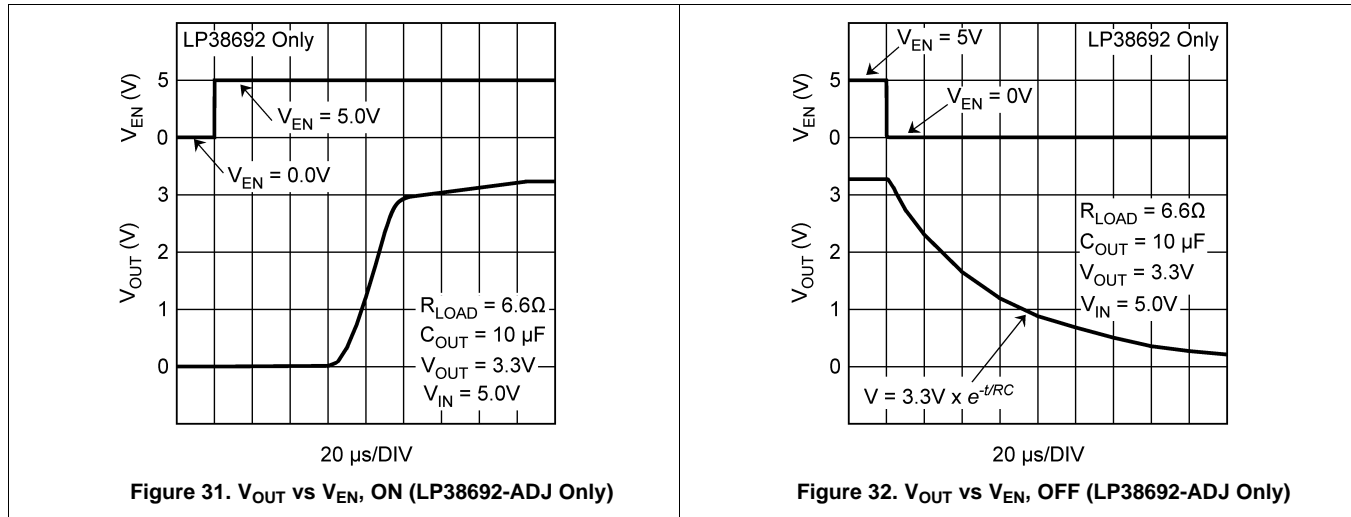

9 Power Supply Recommendations

The LP3869x-ADJ devices are designed to operate from an input supply voltage range of 2.7 V to 10 V. The input supply must be well regulated and free of spurious noise. To ensure that the LP3869x-ADJ output voltage is well regulated, the input supply must be at least $V_{OUT} + 0.5$ V, or 2.7 V, whichever is higher. A minimum capacitor value of 1- μ F is required to be within 1 cm of the IN pin.

10 Layout

10.1 Layout Guidelines

Good PC layout practices must be used or instability can be induced because of ground loops and voltage drops. The input and output capacitors must be directly connected to the IN, OUT, and GND pins of the regulator using traces which do not have other currents flowing in them (Kelvin connect).

The best way to do this is to lay out C_{IN} and C_{OUT} near the device with short traces to the IN, OUT, and GND pins. The regulator ground pin must be connected to the external circuit ground so that the regulator and its capacitors have a *single point ground*.

Stability problems have been seen in applications where vias to an internal ground plane were used at the ground points of the device and the input and output capacitors. This was caused by varying ground potentials at these nodes resulting from current flowing through the ground plane. Using a single point ground technique for the regulator and the regulator capacitors fix the problem. Because high current flows through the traces going into IN and coming from OUT, Kelvin connect the capacitor leads to these pins so there is no voltage drop in series with the input and output capacitors.

10.2 Layout Examples

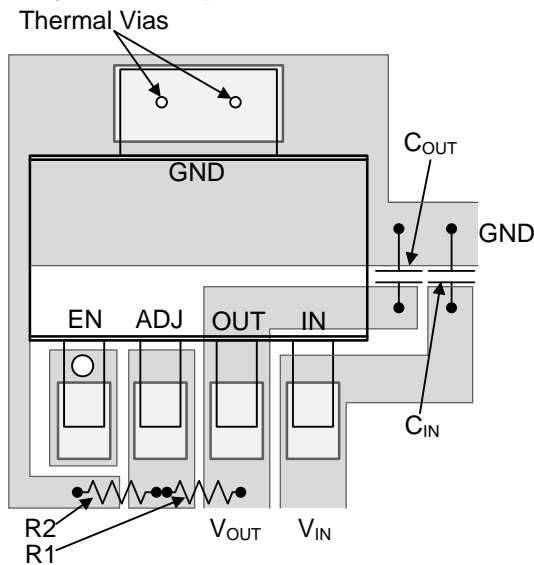

Figure 33. LP38692-ADJ SOT-223 Package

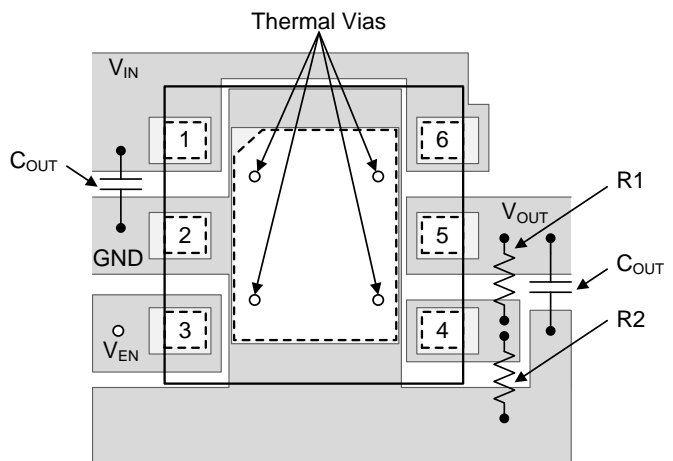

Figure 34. LP3869x-ADJ WSON Package

10.3 WSON Mounting

The NGG0006A (No Pullback) 6-lead WSON package requires specific mounting techniques which are detailed in *AN-1187 Leadless Leadframe Package (LLP)*, [SNOA401](#). The pad style which to use with the WSON package is the NSMD (non-solder mask defined) type. Additionally, TI recommends the PCB terminal pads to be 0.2 mm longer than the package pads to create a solder fillet to improve reliability and inspection.

The input current is split between two IN pins, 1 and 6. The two IN pins must be connected together to ensure that the device can meet all specifications at the rated current.

The thermal dissipation of the WSON package is directly related to the printed circuit board construction and the amount of additional copper area connected to the DAP.

The DAP (exposed pad) on the bottom of the WSON package is connected to the die substrate with a conductive die attach adhesive. The DAP has no direct electrical (wire) connection to any of the pins. There is a parasitic PN junction between the die substrate and the device ground. As such, it is strongly recommended that the DAP be connected directly to the ground at device lead 2 (that is, GND). Alternately, but not recommended, the DAP may be left floating (that is, no electrical connection). The DAP must not be connected to any potential other than ground.

11 Device and Documentation Support

11.1 Device Support

11.1.1 Third-Party Products Disclaimer

TI'S PUBLICATION OF INFORMATION REGARDING THIRD-PARTY PRODUCTS OR SERVICES DOES NOT CONSTITUTE AN ENDORSEMENT REGARDING THE SUITABILITY OF SUCH PRODUCTS OR SERVICES OR A WARRANTY, REPRESENTATION OR ENDORSEMENT OF SUCH PRODUCTS OR SERVICES, EITHER ALONE OR IN COMBINATION WITH ANY TI PRODUCT OR SERVICE.

11.2 Documentation Support

11.2.1 Related Documentation

For related documentation see the following:

- *AN-1187 Leadless Leadframe Package (LLP)* ([SNOA401](#))
- *Semiconductor and IC Package Thermal Metrics* ([SPRA953](#))
- *Using New Thermal Metrics* ([SBVA025](#))
- *Thermal Characteristics of Linear and Logic Packages Using JEDEC PCB Designs* ([SZZA017](#))

11.3 Related Links

[Table 2](#) lists quick access links. Categories include technical documents, support and community resources, tools and software, and quick access to sample or buy.

Table 2. Related Links

PARTS	PRODUCT FOLDER	SAMPLE & BUY	TECHNICAL DOCUMENTS	TOOLS & SOFTWARE	SUPPORT & COMMUNITY
LP38690-ADJ	Click here	Click here	Click here	Click here	Click here
LP38692-ADJ	Click here	Click here	Click here	Click here	Click here

11.4 Community Resources

The following links connect to TI community resources. Linked contents are provided "AS IS" by the respective contributors. They do not constitute TI specifications and do not necessarily reflect TI's views; see TI's [Terms of Use](#).

TI E2E™ Online Community *TI's Engineer-to-Engineer (E2E) Community*. Created to foster collaboration among engineers. At e2e.ti.com, you can ask questions, share knowledge, explore ideas and help solve problems with fellow engineers.

Design Support *TI's Design Support* Quickly find helpful E2E forums along with design support tools and contact information for technical support.

11.5 Trademarks

E2E is a trademark of Texas Instruments.
All other trademarks are the property of their respective owners.

11.6 Electrostatic Discharge Caution



These devices have limited built-in ESD protection. The leads should be shorted together or the device placed in conductive foam during storage or handling to prevent electrostatic damage to the MOS gates.

11.7 Glossary

[SLYZ022](#) — *TI Glossary*.

This glossary lists and explains terms, acronyms, and definitions.

12 Mechanical, Packaging, and Orderable Information

The following pages include mechanical, packaging, and orderable information. This information is the most current data available for the designated devices. This data is subject to change without notice and revision of this document. For browser-based versions of this data sheet, refer to the left-hand navigation.

PACKAGING INFORMATION

Orderable Device	Status (1)	Package Type	Package Drawing	Pins	Package Qty	Eco Plan (2)	Lead finish/ Ball material (6)	MSL Peak Temp (3)	Op Temp (°C)	Device Marking (4/5)	Samples
LP38690SD-ADJ/NOPB	ACTIVE	WSON	NGG	6	1000	RoHS & Green	NIPDAU SN	Level-1-260C-UNLIM	-40 to 125	L112B	Samples
LP38690SDX-ADJ/NOPB	ACTIVE	WSON	NGG	6	4500	RoHS & Green	NIPDAU SN	Level-1-260C-UNLIM	-40 to 125	L112B	Samples
LP38692MP-ADJ/NOPB	ACTIVE	SOT-223	NDC	5	1000	RoHS & Green	SN	Level-1-260C-UNLIM	-40 to 125	LJNB	Samples
LP38692MPX-ADJ/NOPB	ACTIVE	SOT-223	NDC	5	2000	RoHS & Green	SN	Level-1-260C-UNLIM	-40 to 125	LJNB	Samples
LP38692SD-ADJ/NOPB	ACTIVE	WSON	NGG	6	1000	RoHS & Green	SN	Level-1-260C-UNLIM	-40 to 125	L122B	Samples
LP38692SDX-ADJ/NOPB	ACTIVE	WSON	NGG	6	4500	RoHS & Green	SN	Level-1-260C-UNLIM	-40 to 125	L122B	Samples

(1) The marketing status values are defined as follows:

ACTIVE: Product device recommended for new designs.

LIFEBUY: TI has announced that the device will be discontinued, and a lifetime-buy period is in effect.

NRND: Not recommended for new designs. Device is in production to support existing customers, but TI does not recommend using this part in a new design.

PREVIEW: Device has been announced but is not in production. Samples may or may not be available.

OBSOLETE: TI has discontinued the production of the device.

(2) **RoHS:** TI defines "RoHS" to mean semiconductor products that are compliant with the current EU RoHS requirements for all 10 RoHS substances, including the requirement that RoHS substance do not exceed 0.1% by weight in homogeneous materials. Where designed to be soldered at high temperatures, "RoHS" products are suitable for use in specified lead-free processes. TI may reference these types of products as "Pb-Free".

RoHS Exempt: TI defines "RoHS Exempt" to mean products that contain lead but are compliant with EU RoHS pursuant to a specific EU RoHS exemption.

Green: TI defines "Green" to mean the content of Chlorine (Cl) and Bromine (Br) based flame retardants meet JS709B low halogen requirements of <=1000ppm threshold. Antimony trioxide based flame retardants must also meet the <=1000ppm threshold requirement.

(3) MSL, Peak Temp. - The Moisture Sensitivity Level rating according to the JEDEC industry standard classifications, and peak solder temperature.

(4) There may be additional marking, which relates to the logo, the lot trace code information, or the environmental category on the device.

(5) Multiple Device Markings will be inside parentheses. Only one Device Marking contained in parentheses and separated by a "~" will appear on a device. If a line is indented then it is a continuation of the previous line and the two combined represent the entire Device Marking for that device.

(6) Lead finish/Ball material - Orderable Devices may have multiple material finish options. Finish options are separated by a vertical ruled line. Lead finish/Ball material values may wrap to two lines if the finish value exceeds the maximum column width.

Important Information and Disclaimer: The information provided on this page represents TI's knowledge and belief as of the date that it is provided. TI bases its knowledge and belief on information provided by third parties, and makes no representation or warranty as to the accuracy of such information. Efforts are underway to better integrate information from third parties. TI has taken and continues to take reasonable steps to provide representative and accurate information but may not have conducted destructive testing or chemical analysis on incoming materials and chemicals. TI and TI suppliers consider certain information to be proprietary, and thus CAS numbers and other limited information may not be available for release.

In no event shall TI's liability arising out of such information exceed the total purchase price of the TI part(s) at issue in this document sold by TI to Customer on an annual basis.

TAPE AND REEL INFORMATION

QUADRANT ASSIGNMENTS FOR PIN 1 ORIENTATION IN TAPE

*All dimensions are nominal

Device	Package Type	Package Drawing	Pins	SPQ	Reel Diameter (mm)	Reel Width W1 (mm)	A0 (mm)	B0 (mm)	K0 (mm)	P1 (mm)	W (mm)	Pin1 Quadrant
LP38690SD-ADJ/NOPB	WSON	NGG	6	1000	178.0	12.4	3.3	3.3	1.0	8.0	12.0	Q1
LP38690SDX-ADJ/NOPB	WSON	NGG	6	4500	330.0	12.4	3.3	3.3	1.0	8.0	12.0	Q1
LP38692MP-ADJ/NOPB	SOT-223	NDC	5	1000	330.0	16.4	7.0	7.5	2.2	12.0	16.0	Q3
LP38692MPX-ADJ/NOPB	SOT-223	NDC	5	2000	330.0	16.4	7.0	7.5	2.2	12.0	16.0	Q3
LP38692SD-ADJ/NOPB	WSON	NGG	6	1000	178.0	12.4	3.3	3.3	1.0	8.0	12.0	Q1
LP38692SDX-ADJ/NOPB	WSON	NGG	6	4500	330.0	12.4	3.3	3.3	1.0	8.0	12.0	Q1

TAPE AND REEL BOX DIMENSIONS



*All dimensions are nominal

Device	Package Type	Package Drawing	Pins	SPQ	Length (mm)	Width (mm)	Height (mm)
LP38690SD-ADJ/NOPB	WSON	NGG	6	1000	208.0	191.0	35.0
LP38690SDX-ADJ/NOPB	WSON	NGG	6	4500	367.0	367.0	35.0
LP38692MP-ADJ/NOPB	SOT-223	NDC	5	1000	367.0	367.0	35.0
LP38692MPX-ADJ/NOPB	SOT-223	NDC	5	2000	367.0	367.0	35.0
LP38692SD-ADJ/NOPB	WSON	NGG	6	1000	208.0	191.0	35.0
LP38692SDX-ADJ/NOPB	WSON	NGG	6	4500	367.0	367.0	35.0

NDC0005A

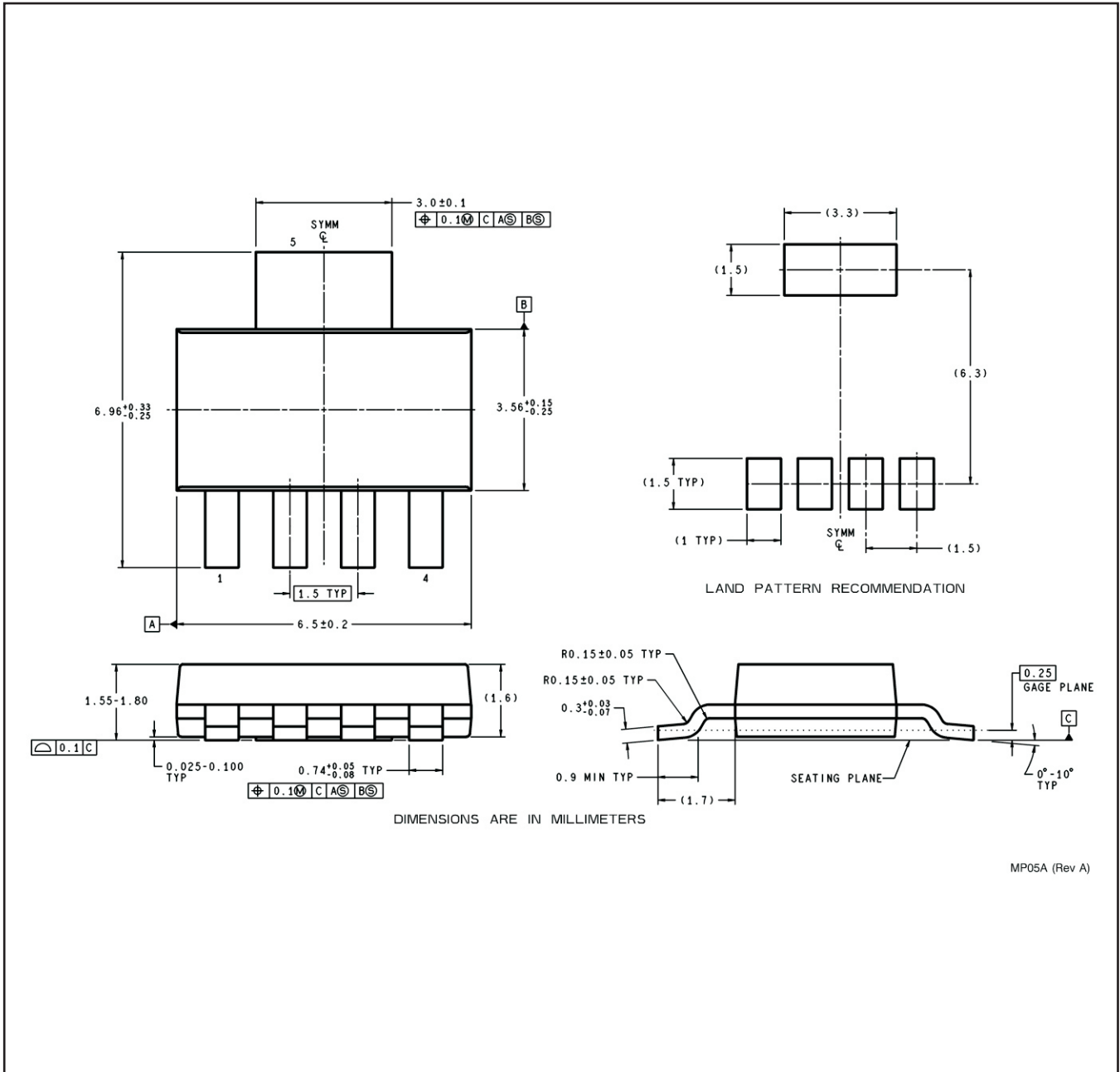

MP05A (Rev A)

NGG0006A



RECOMMENDED LAND PATTERN

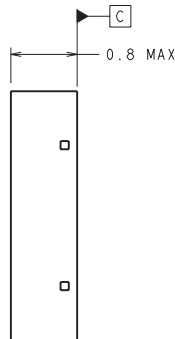
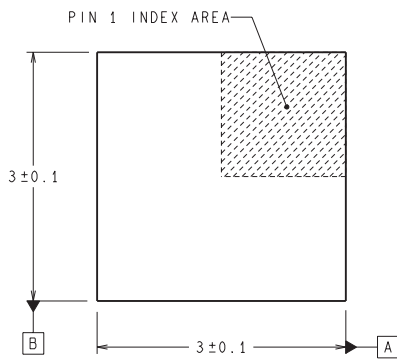

DIMENSIONS ARE IN MILLIMETERS
DIMENSION IN () FOR REFERENCE ONLY

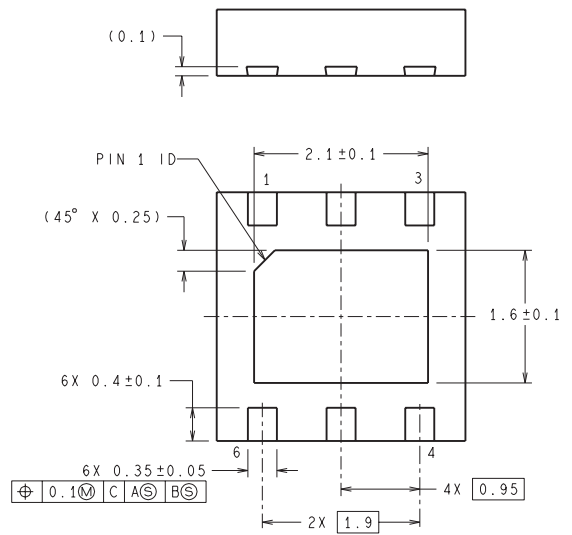

SDE06A (Rev A)

IMPORTANT NOTICE AND DISCLAIMER

TI PROVIDES TECHNICAL AND RELIABILITY DATA (INCLUDING DATA SHEETS), DESIGN RESOURCES (INCLUDING REFERENCE DESIGNS), APPLICATION OR OTHER DESIGN ADVICE, WEB TOOLS, SAFETY INFORMATION, AND OTHER RESOURCES "AS IS" AND WITH ALL FAULTS, AND DISCLAIMS ALL WARRANTIES, EXPRESS AND IMPLIED, INCLUDING WITHOUT LIMITATION ANY IMPLIED WARRANTIES OF MERCHANTABILITY, FITNESS FOR A PARTICULAR PURPOSE OR NON-INFRINGEMENT OF THIRD PARTY INTELLECTUAL PROPERTY RIGHTS.

These resources are intended for skilled developers designing with TI products. You are solely responsible for (1) selecting the appropriate TI products for your application, (2) designing, validating and testing your application, and (3) ensuring your application meets applicable standards, and any other safety, security, regulatory or other requirements.

These resources are subject to change without notice. TI grants you permission to use these resources only for development of an application that uses the TI products described in the resource. Other reproduction and display of these resources is prohibited. No license is granted to any other TI intellectual property right or to any third party intellectual property right. TI disclaims responsibility for, and you will fully indemnify TI and its representatives against, any claims, damages, costs, losses, and liabilities arising out of your use of these resources.

TI's products are provided subject to [TI's Terms of Sale](#) or other applicable terms available either on [ti.com](https://www.ti.com) or provided in conjunction with such TI products. TI's provision of these resources does not expand or otherwise alter TI's applicable warranties or warranty disclaimers for TI products.

TI objects to and rejects any additional or different terms you may have proposed.

Mailing Address: Texas Instruments, Post Office Box 655303, Dallas, Texas 75265
Copyright © 2024, Texas Instruments Incorporated