

NCP4688

Voltage Regulator - Low Noise, LDO Linear

150 mA

The NCP4688 is a CMOS 150 mA LDO linear voltage regulator with high output voltage accuracy which features a low noise output voltage and high ripple rejection. The low level of output noise 10 μ Vrms typically is kept at any output voltage. The very common SOT23-5 package and small μ DFN 1x1 package are suitable for industrial applications, portable communication equipments and RF modules.

Features

- Operating Input Voltage Range: 2 V to 5.25 V
- Output Voltage Range: 1.2 to 4.8 V (available in 0.1 V steps)
- $\pm 1\%$ Output Voltage Accuracy
- Output Noise: 10 μ Vrms
- Line Regulation: 0.02%/V
- Current Limit Circuit
- High PSRR: 80 dB at 1 kHz, 75 dB at 10 kHz
- Available in SOT-23-5 and μ DFN 1.0 x 1.0 mm Package
- These are Pb-Free Devices

Typical Applications

- Home Appliances, Industrial Equipment
- Cable Boxes, Satellite Receivers, Entertainment Systems
- Car Audio Equipment, Navigation Systems
- Notebook Adaptors, LCD TVs, Cordless Phones and Private LAN Systems
- RF Modules

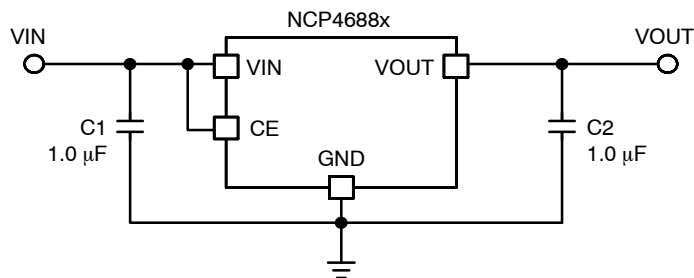

Figure 1. Typical Application Schematic



ON Semiconductor™

<http://onsemi.com>

MARKING DIAGRAMS



SOT-23-5
CASE 1212

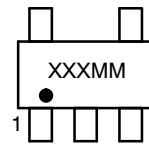

UDFN-4
CASE 517BR

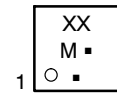

(Top Views)

XX, XXX = Specific Device Code
M, MM = Date Code
▪ = Pb-Free Package

(*Note: Microdot may be in either location)

ORDERING INFORMATION

See detailed ordering and shipping information in the package dimensions section on page 12 of this data sheet.

NCP4688

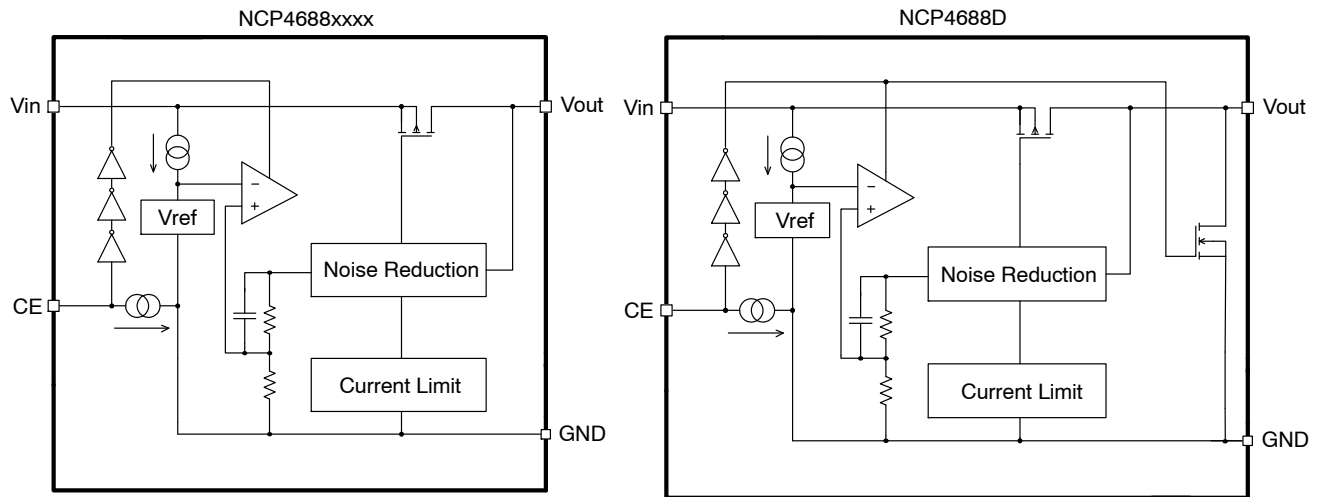

Figure 2. Simplified Schematic Block Diagram

Table 1. PIN FUNCTION DESCRIPTION

Pin No. SOT-23-5	Pin No. DFN 1x1	Pin Name	Description
1	4	VIN	Input pin
2	2	GND	Ground pin
3	3	CE	Chip enable pin ("H" active)
4		NC	Non connected
5	1	VOUT	Output pin
	*EP	EP	Exposed Pad (leave floating or connect to GND)

Table 2. ABSOLUTE MAXIMUM RATINGS

Rating	Symbol	Value	Unit
Input Voltage	V_{IN}	0 – 6 V	V
Output Voltage	V_{OUT}	-0.3 to $V_{IN} + 0.3$	V
Chip Enable Input	V_{CE}	0 – 6 V	V
Power Dissipation SOT-23-5	P_D	420	mW
Power Dissipation μ DFN 1.0 x 1.0 mm		400	
Junction Temperature	T_J	-40 to 150	°C
Storage Temperature	T_{STG}	-55 to 125	°C
ESD Capability, Human Body Model (Note 1)	ESD_{HBM}	2000	V
ESD Capability, Machine Model (Note 1)	ESD_{MM}	200	V

Stresses exceeding Maximum Ratings may damage the device. Maximum Ratings are stress ratings only. Functional operation above the Recommended Operating Conditions is not implied. Extended exposure to stresses above the Recommended Operating Conditions may affect device reliability.

- This device series incorporates ESD protection and is tested by the following methods:
 - ESD Human Body Model tested per AEC-Q100-002 (EIA/JESD22-A114)
 - ESD Machine Model tested per AEC-Q100-003 (EIA/JESD22-A115)
 - Latchup Current Maximum Rating tested per JEDEC standard: JESD78

NCP4688

Table 3. THERMAL CHARACTERISTICS

Rating	Symbol	Value	Unit
Thermal Characteristics, SOT–23–5 Thermal Resistance, Junction–to–Air	$R_{\theta JA}$	238	$^{\circ}\text{C}/\text{W}$
Thermal Characteristics, $\mu\text{DFN } 1 \times 1$ Thermal Resistance, Junction–to–Air	$R_{\theta JA}$	250	$^{\circ}\text{C}/\text{W}$

Table 4. ELECTRICAL CHARACTERISTICS

($-40^{\circ}\text{C} \leq T_A \leq 85^{\circ}\text{C}$; $C_{IN} = C_{OUT} = 1.0 \mu\text{F}$, unless otherwise noted. Typical values are at $T_A = +25^{\circ}\text{C}$.)

Parameter	Test Conditions		Symbol	Min	Typ	Max	Unit
Operating Input Voltage	$1.2 \text{ V} < V_{\text{out}} < 4.8 \text{ V}$		V_{IN}	2.0		5.25	V
Output Voltage	$T_a = 25^{\circ}\text{C}$, $V_{\text{out}} > 2.0 \text{ V}$		V_{OUT}	x0.99		x1.01	V
	$-40^{\circ}\text{C} < T_a < 85^{\circ}\text{C}$, $V_{\text{out}} > 2.0 \text{ V}$			x0.985		x1.015	V
	$T_a = 25^{\circ}\text{C}$, $V_{\text{out}} \leq 2.0 \text{ V}$			-20		+20	mV
	$-40^{\circ}\text{C} < T_a < 85^{\circ}\text{C}$, $V_{\text{out}} \leq 2.0 \text{ V}$			-30		+30	mV
Output Voltage Temp. Coefficient	$-40^{\circ}\text{C} < T_a < 85^{\circ}\text{C}$				± 100		ppm/ $^{\circ}\text{C}$
Line Regulation	Set $V_{\text{out}} + 0.3 < V_{\text{IN}} < 5.25 \text{ V}$	$V_{\text{out}} > 4.1 \text{ V}$	LineReg		0.02	0.10	%/V
	Set $V_{\text{out}} + 0.5 < V_{\text{IN}} < 5.0 \text{ V}$	$1.7 \text{ V} \leq V_{\text{OUT}} < 4.1 \text{ V}$					
	$2.2 < V_{\text{IN}} < 5.0 \text{ V}$	$V_{\text{out}} < 1.7 \text{ V}$					
Load Regulation	$1 \text{ mA} < I_{\text{OUT}} \leq 150 \text{ mA}$		LoadReg	-14	0	14	mV
Dropout Voltage	$I_{\text{OUT}} = 150 \text{ mA}$	$1.2 \text{ V} \leq V_{\text{OUT}} < 1.3 \text{ V}$	V_{DO}		0.39	0.80	V
		$1.3 \text{ V} \leq V_{\text{OUT}} < 1.4 \text{ V}$			0.37	0.70	
		$1.4 \text{ V} \leq V_{\text{OUT}} \leq 1.5 \text{ V}$			0.34	0.60	
		$1.5 \text{ V} \leq V_{\text{OUT}} < 1.7 \text{ V}$			0.32	0.50	
		$1.7 \text{ V} \leq V_{\text{OUT}} < 2.0 \text{ V}$			0.29	0.41	
		$2.0 \text{ V} \leq V_{\text{OUT}} < 2.5 \text{ V}$			0.25	0.36	
		$2.5 \text{ V} \leq V_{\text{OUT}} < 2.8 \text{ V}$			0.22	0.31	
		$2.8 \text{ V} \leq V_{\text{OUT}} \leq 4.8 \text{ V}$			0.20	0.28	
Output Current			I_{OUT}	150			mA
Short Current Limit	$V_{\text{OUT}} = 0 \text{ V}$		I_{SC}		40		mA
Quiescent Current	$I_{\text{out}} = 0 \text{ mA}$	$V_{\text{out}} > 4.1 \text{ V}$	I_{Q}		80	100	μA
		$V_{\text{out}} \leq 4.1 \text{ V}$			75		
Standby Current	$V_{\text{IN}} = V_{\text{IN max}}$, $V_{\text{CE}} = 0 \text{ V}$		I_{STB}		0.1	1.0	μA
CE Pin Pull–Down Current			I_{PD}		0.3	0.6	μA
CE Pin Threshold Voltage	CE Input Voltage “H”		V_{CEH}	1.0		V_{IN}	V
	CE Input Voltage “L”		V_{CEL}			0.4	
Power Supply Rejection Ratio	$V_{\text{OUT}} > 4.1 \text{ V}$ @ $V_{\text{IN}} = 5.25 \text{ V}$, $V_{\text{OUT}} \leq 4.1 \text{ V}$ @ $V_{\text{IN}} =$ Set $V_{\text{OUT}} + 1.0 \text{ V}$, $\Delta V_{\text{IN_PK-PK}} = 0.2 \text{ V}$, $I_{\text{OUT}} = 30 \text{ mA}$	$f = 1 \text{ kHz}$	PSRR		80		dB
		$f = 10 \text{ kHz}$			75		
		$f = 100 \text{ kHz}$			65		
Output Noise Voltage	$I_{\text{OUT}} = 30 \text{ mA}$, $f = 10 \text{ Hz}$ to 100 kHz		V_{NOISE}		10		μV_{rms}
Autodischarge NMOS Resistance	$V_{\text{IN}} = 4.0 \text{ V}$, $V_{\text{CE}} = 0.0 \text{ V}$		R_{DSON}		60		ohm

NCP4688

TYPICAL CHARACTERISTICS

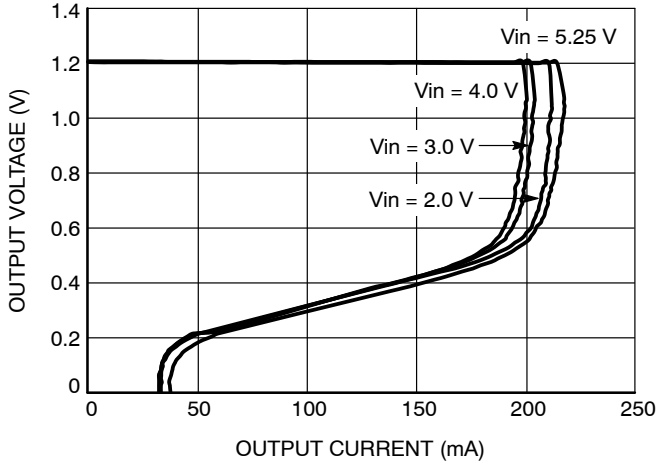

Figure 3. Output Voltage vs. Output Current
NCP4688xx12

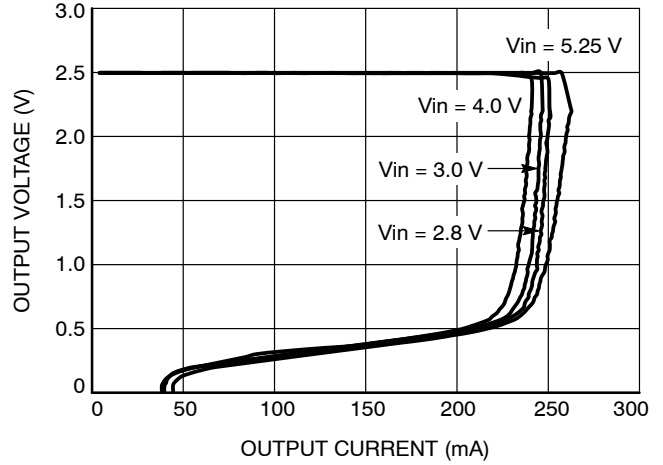

Figure 4. Output Voltage vs. Output Current
NCP4688xx25

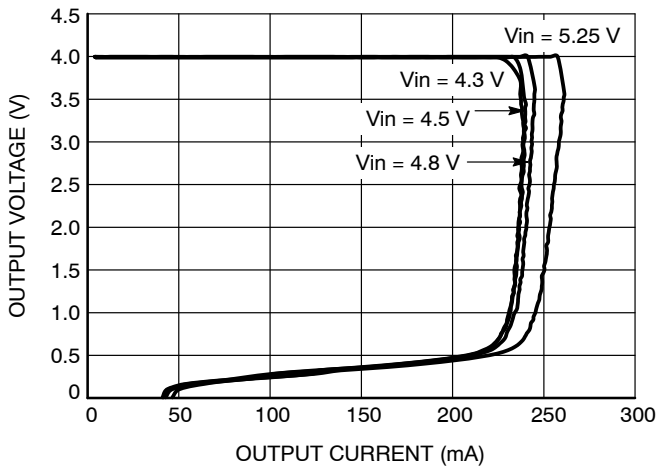

Figure 5. Output Voltage vs. Output Current
NCP4688xx40

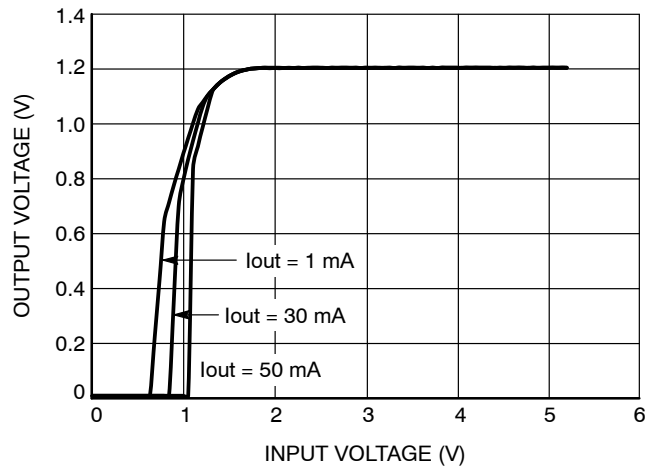

Figure 6. Output Voltage vs. Input Voltage
NCP4688xx12

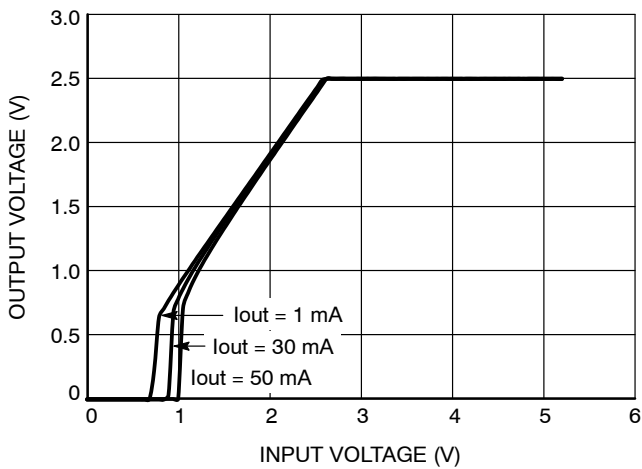

Figure 7. Output Voltage vs. Input Voltage
NCP4688xx25

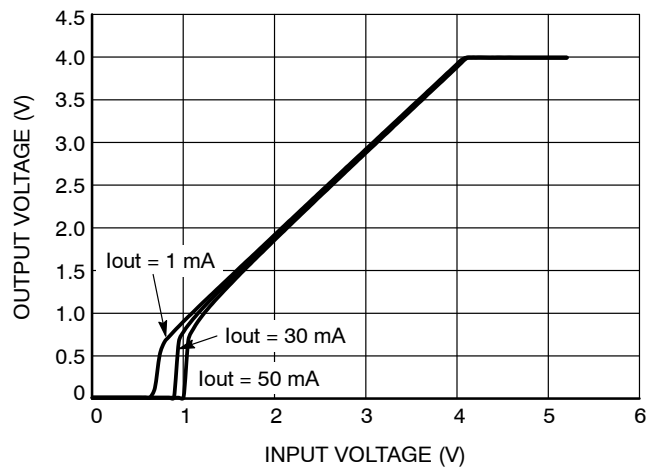

Figure 8. Output Voltage vs. Input Voltage
NCP4688xx40

NCP4688

TYPICAL CHARACTERISTICS

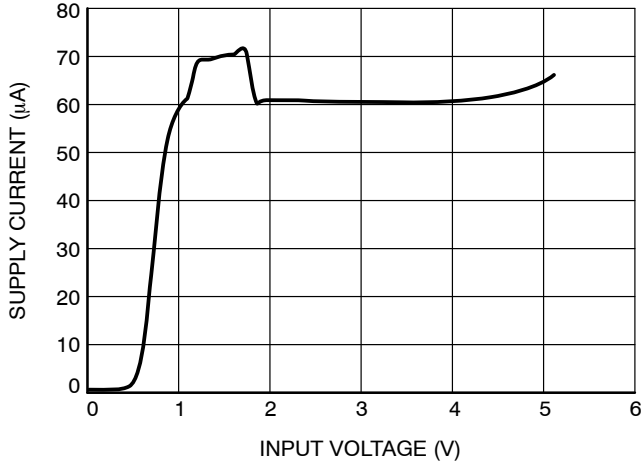

Figure 9. Supply Current vs. Input Voltage
NCP4688xx12

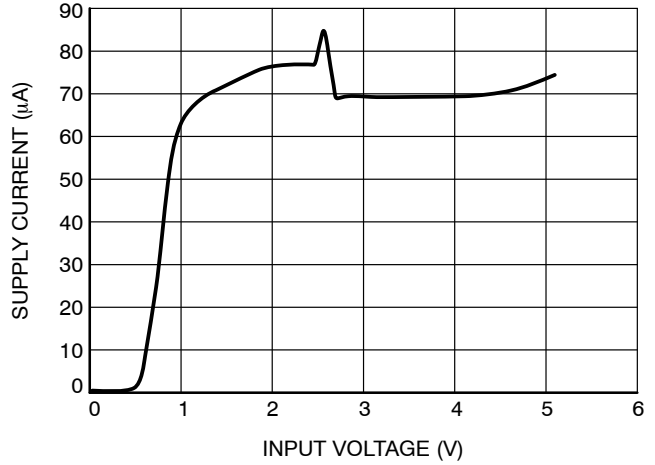

Figure 10. Supply Current vs. Input Voltage
NCP4688xx25

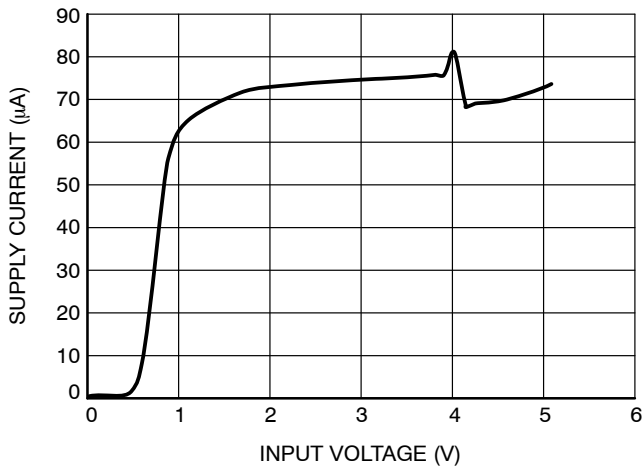

Figure 11. Supply Current vs. Input Voltage
NCP4688xx40

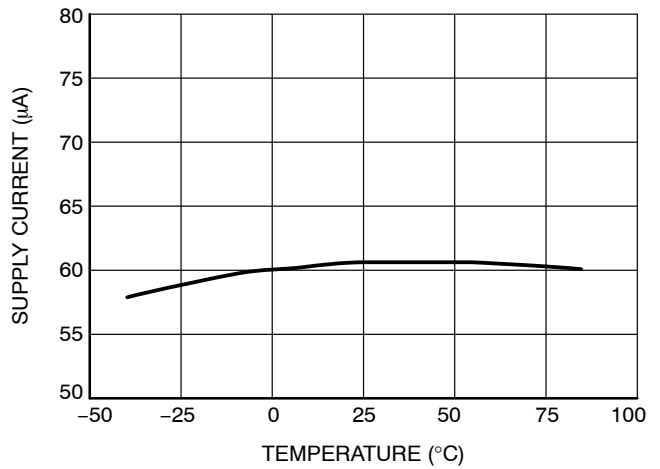

Figure 12. Supply Current vs. Temperature
NCP4688xx12

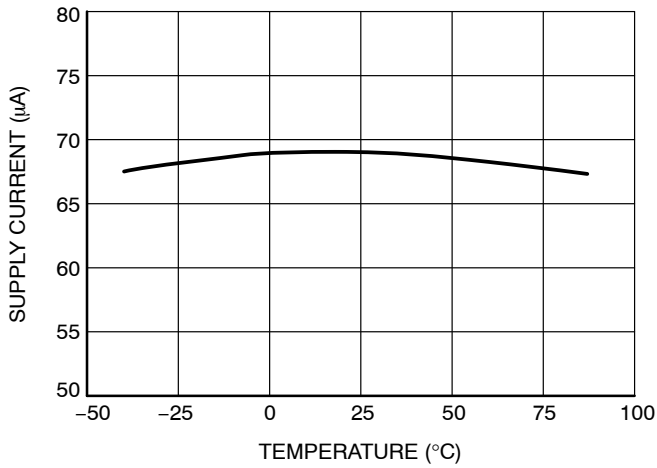

Figure 13. Supply Current vs. Temperature
NCP4688xx25

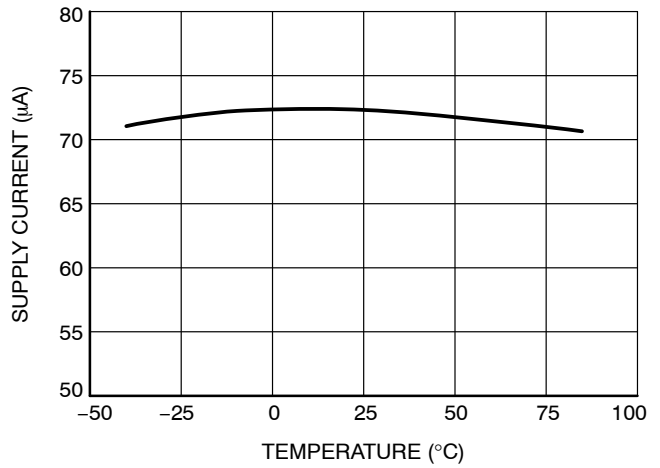
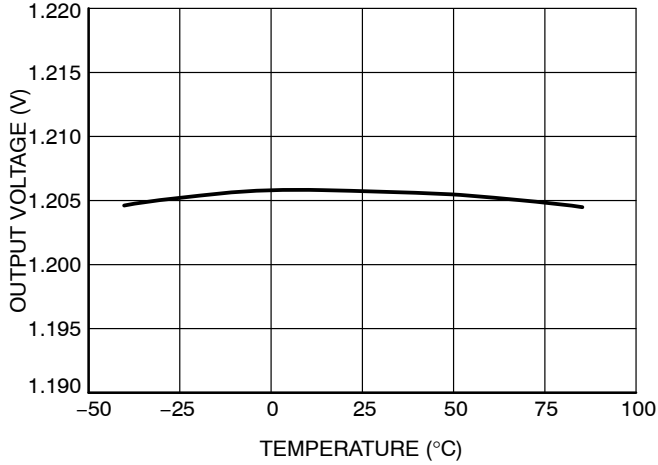

Figure 14. Supply Current vs. Temperature
NCP4688xx40

NCP4688

TYPICAL CHARACTERISTICS



**Figure 15. Output Voltage vs. Temperature
NCP4688xx12**

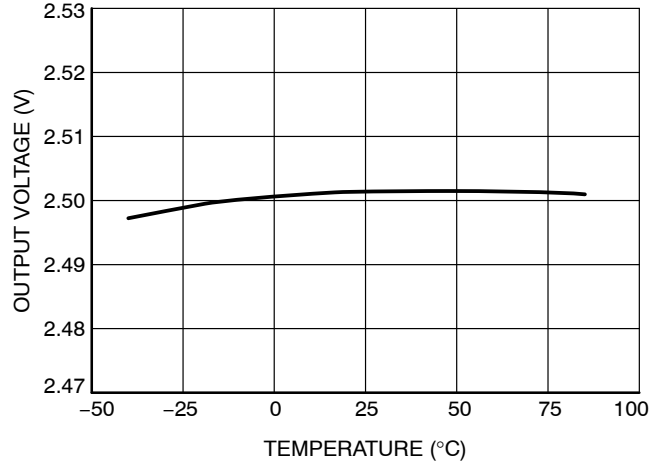

**Figure 16. Output Voltage vs. Temperature
NCP4688xx25**

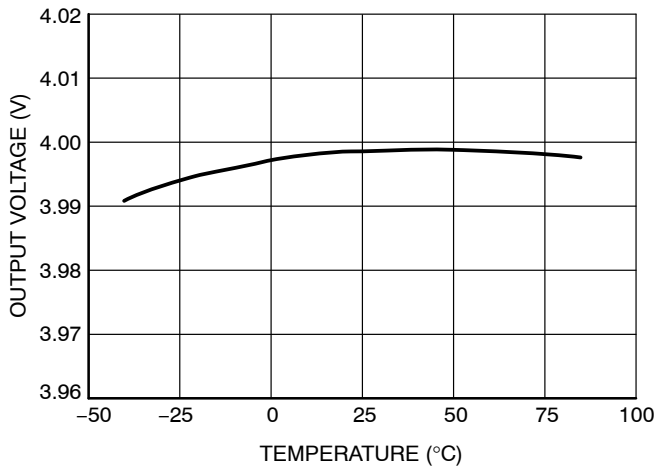

**Figure 17. Output Voltage vs. Temperature
NCP4688xx40**

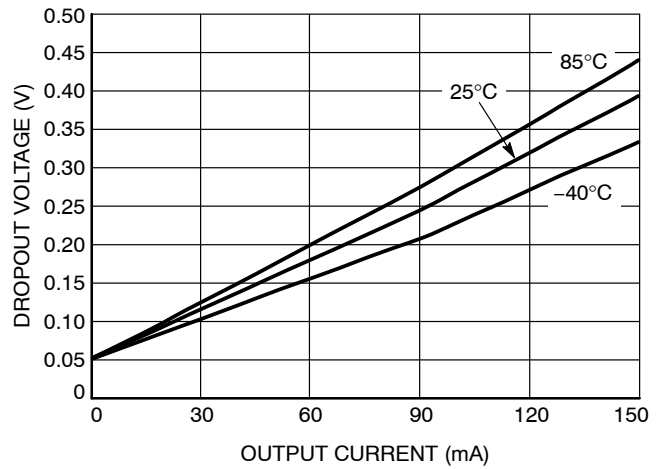

**Figure 18. Dropout Voltage vs. Output Current
NCP4688xx12**

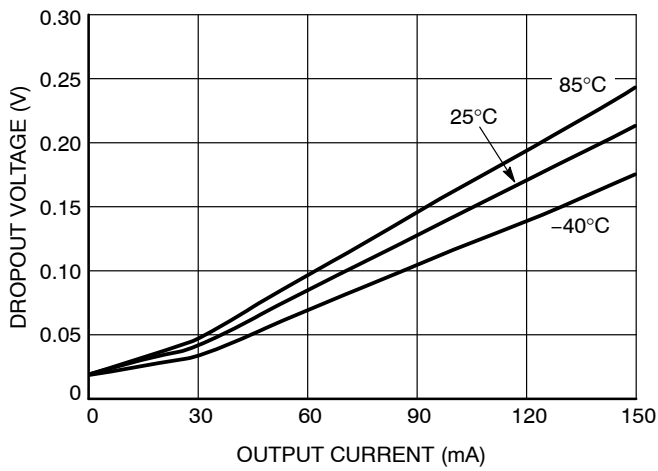

**Figure 19. Dropout Voltage vs. Output Current
NCP4688xx25**

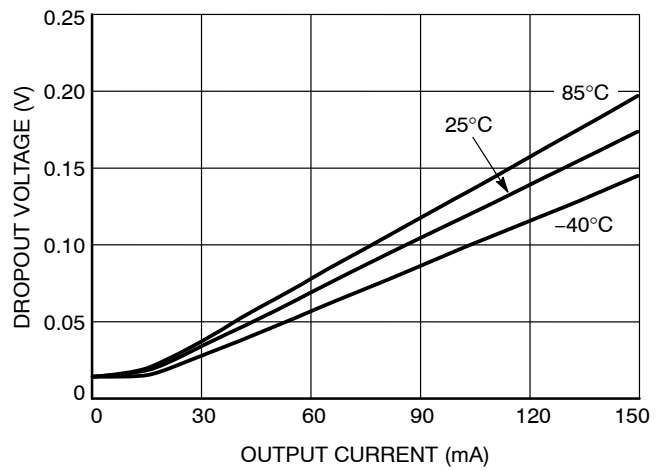

**Figure 20. Dropout Voltage vs. Output Current
NCP4688xx40**

NCP4688

TYPICAL CHARACTERISTICS

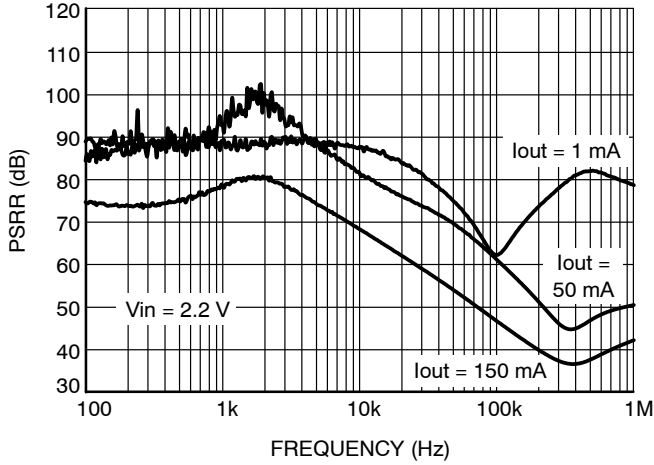

Figure 21. PSRR vs. Frequency NCP4688xx12

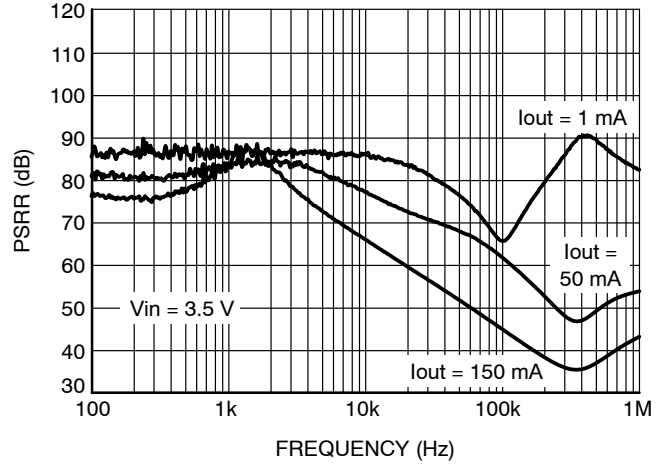

Figure 22. PSRR vs. Frequency NCP4688xx25

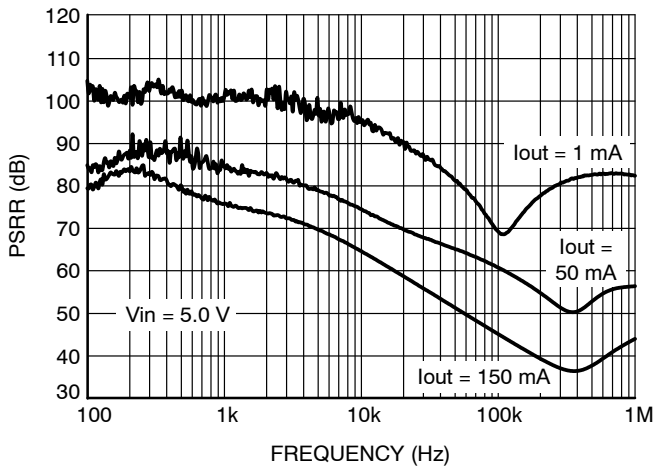

Figure 23. PSRR vs. Frequency NCP4688xx40

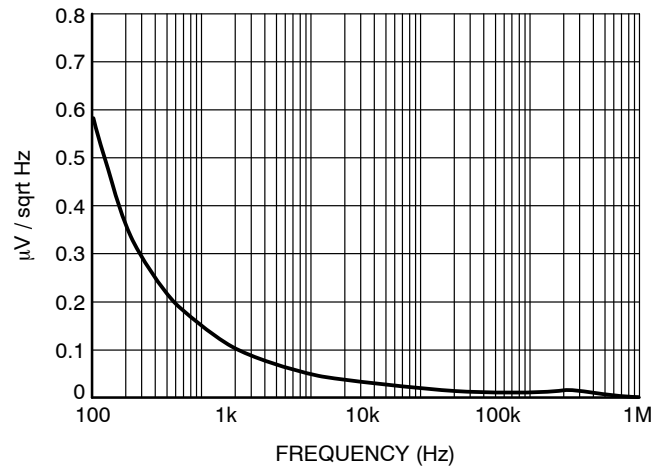

Figure 24. Output Noise Density vs. Frequency NCP4688xx12

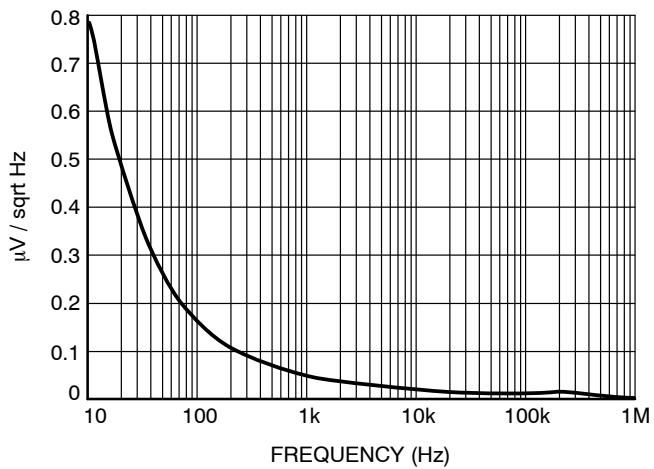

Figure 25. Output Noise Density vs. Frequency NCP4688xx25

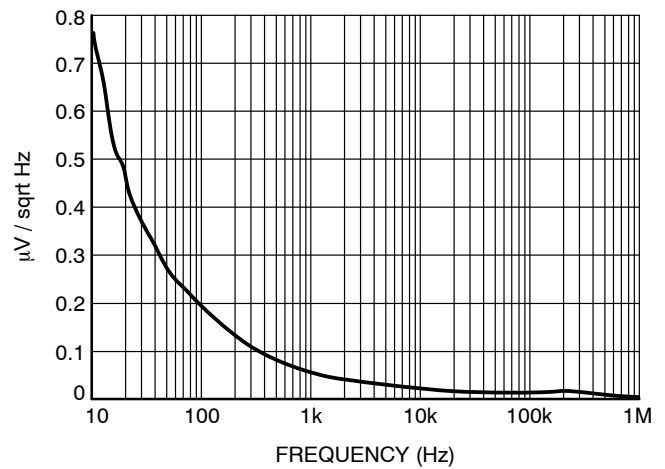

Figure 26. Output Noise Density vs. Frequency NCP4688xx40

TYPICAL CHARACTERISTICS

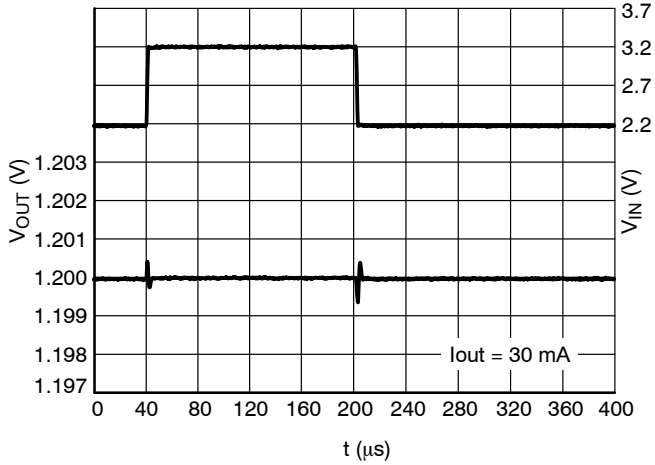

Figure 27. Line Transient Response NCP4688xx12

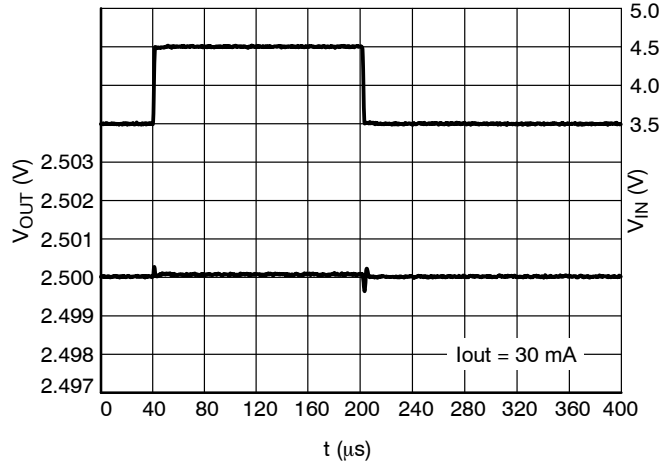

Figure 28. Line Transient Response NCP4688xx25

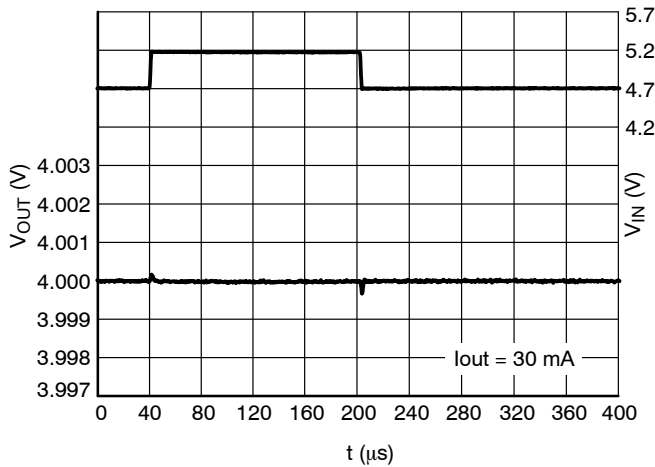

Figure 29. Line Transient Response NCP4688xx40

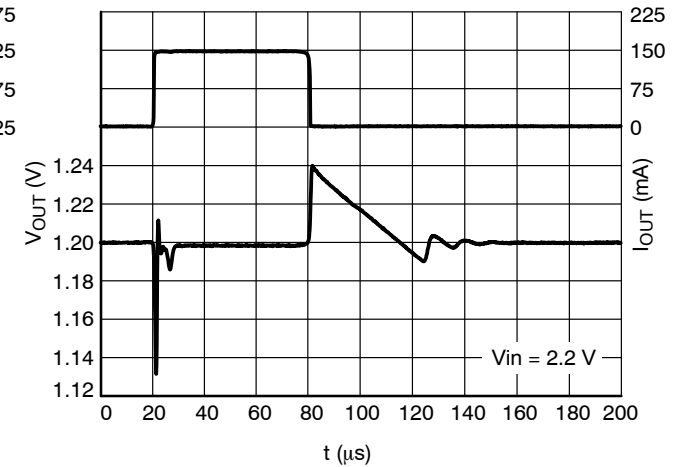

Figure 30. Load Transient Response Load Step 1 mA to 150 mA NCP4688xx12

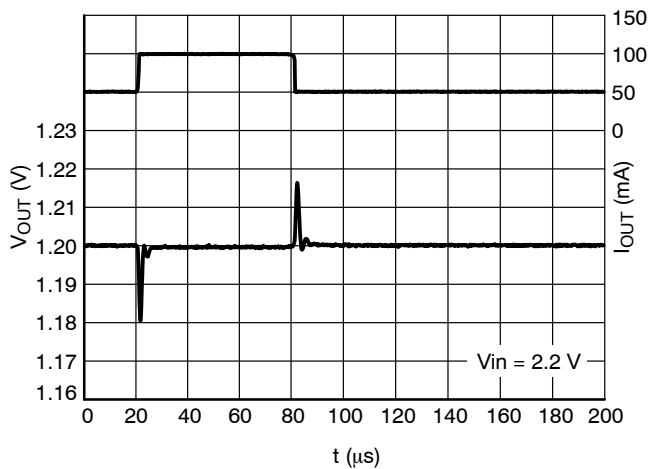

Figure 31. Load Transient Response Load Step 50 mA to 100 mA NCP4688xx12

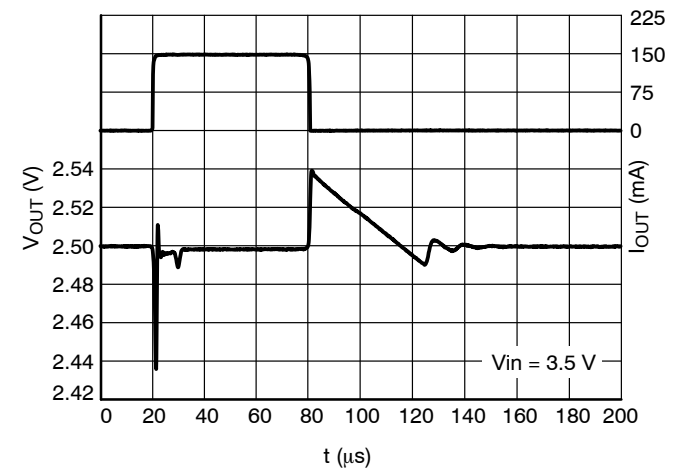

Figure 32. Load Transient Response Load Step 1 mA to 150 mA NCP4688xx25

NCP4688

TYPICAL CHARACTERISTICS

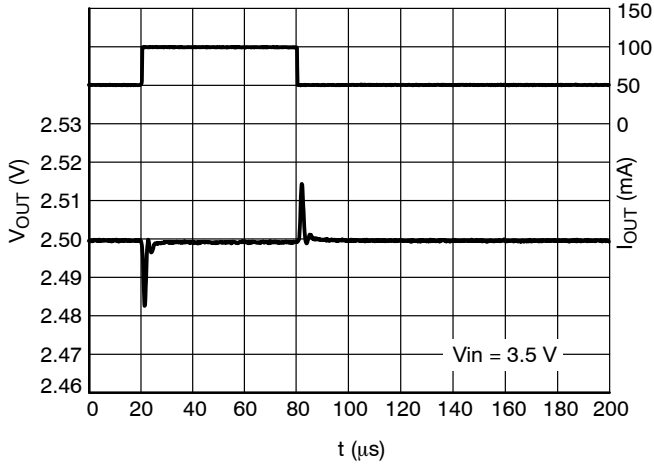

Figure 33. Load Transient Response Load Step 50 mA to 100 mA NCP4688xx25

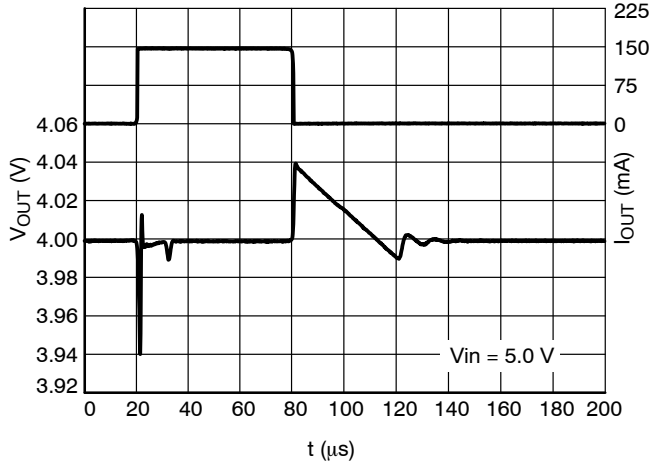

Figure 34. Load Transient Response Load Step 1 mA to 150 mA NCP4688xx40

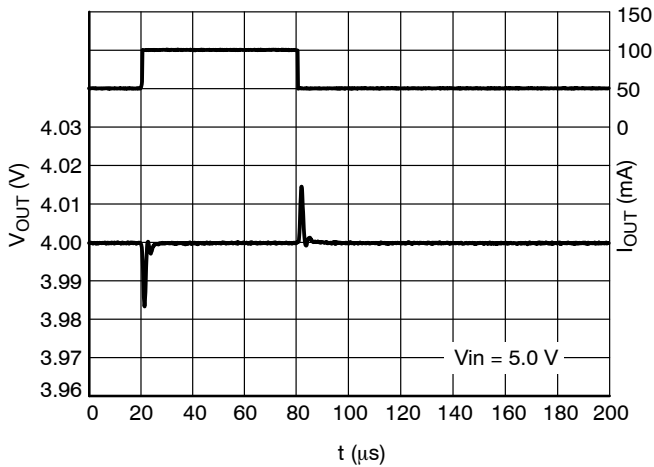

Figure 35. Load Transient Response Load Step 50 mA to 100 mA NCP4688xx40

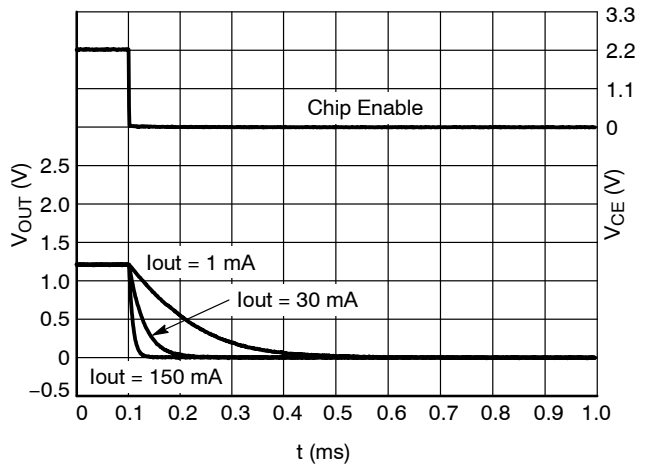

Figure 36. Turn Off with CE Behavior NCP4688Dx12

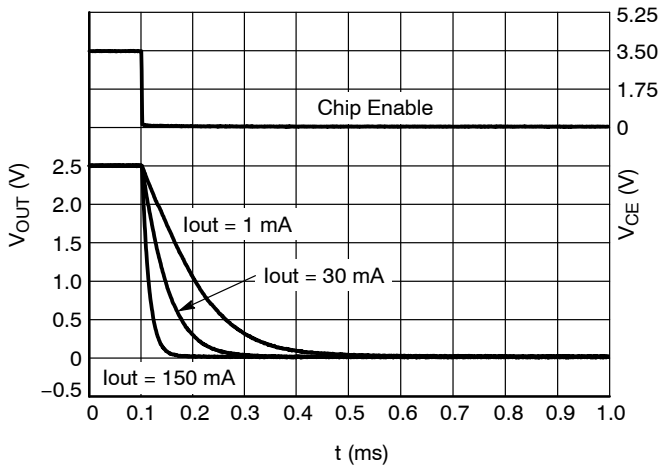

Figure 37. Turn Off with CE Behavior NCP4688Dx25

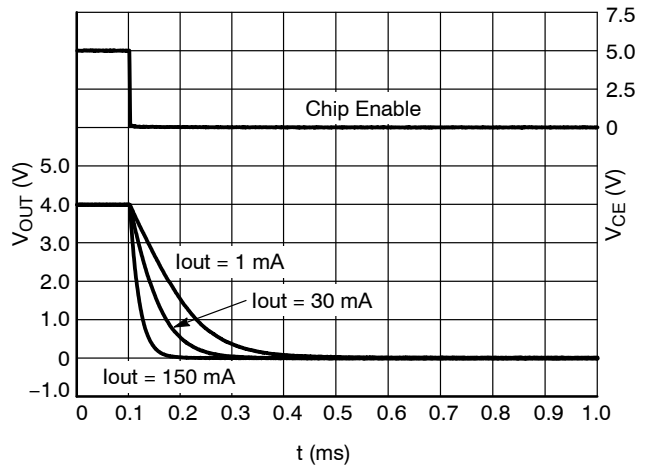
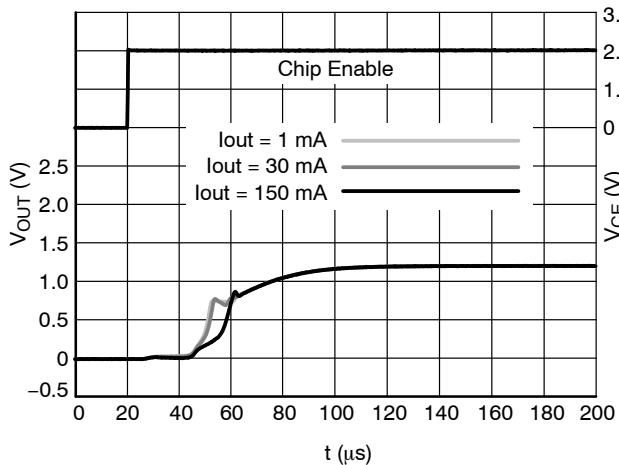

Figure 38. Turn Off with CE Behavior NCP4688Dx40

NCP4688

TYPICAL CHARACTERISTICS



**Figure 39. Turn ON with CE Behavior
NCP4688xx12**

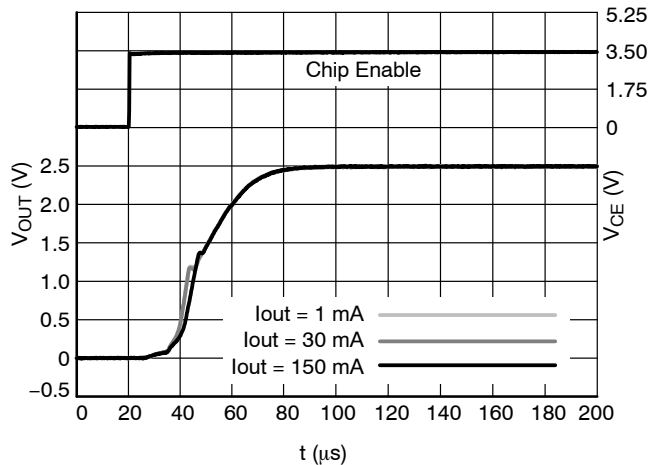

**Figure 40. Turn ON with CE Behavior
NCP4688xx25**

APPLICATION INFORMATION

A typical application circuit for NCP4688 series is shown in the Figure 41.

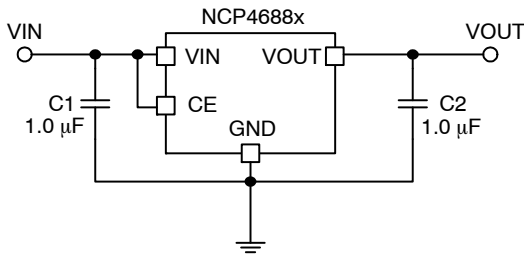

Figure 41. Typical Application Schematic

Input Decoupling Capacitor (C1)

A 1.0 μF ceramic input decoupling capacitor should be connected as close as possible to the input and ground pin of the NCP4688 device. Higher values and lower ESR improves line transient response.

Output Decoupling Capacitor (C2)

A 1.0 μF ceramic output decoupling capacitor is sufficient to achieve stable operation of the device. If tantalum capacitor is used, and its ESR is high, the loop oscillation may result. For information about ESR see Figures 42, 43 and 44. The capacitor should be connected as close as possible to the output and ground pin. Larger values and lower ESR improves dynamic parameters.

Enable Operation

The enable pin CE may be used for turning the regulator on and off. The IC is switched on when a high level voltage is applied to the CE pin. The enable pin has an internal pull down current source which assure off state of LDO in case the CE pin will stay floating. If the enable function is not needed connect CE pin to VIN.

The D version of the NCP4688 device includes a transistor between VOUT and GND that is used for faster discharging of the output capacitor. This function is activated when the IC goes into disable mode.

Thermal Consideration

As a power across the IC increase, it might become necessary to provide some thermal relief. The maximum power dissipation supported by the device is dependent upon board design and layout. Mounting pad configuration on the PCB, the board material, and also the ambient temperature affect the rate of temperature increase for the part. When the device has good thermal conductivity through the PCB the junction temperature will be relatively low in high power dissipation applications.

ESR vs. Output Current

When using the NCP4688 devices, consider the following points:

The relation between Output Current Iout and ESR of the output capacitor are shown below in Figures 42, 43 and 44. The conditions when the device performs stable operation are marked as the hatched area in the charts.

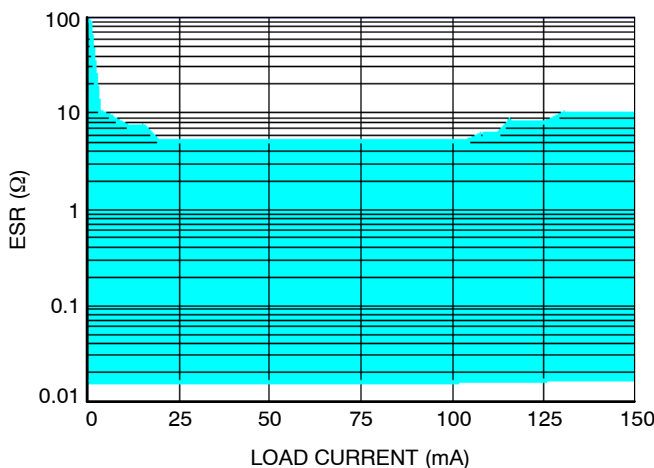

Figure 42. ESR vs. Load Current NCP4688xx12

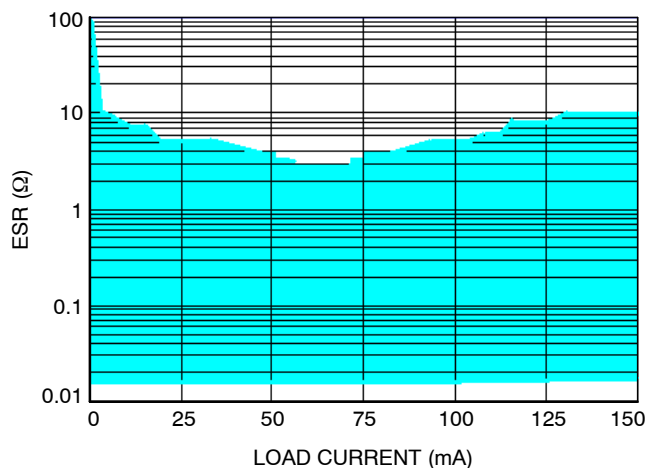

Figure 43. ESR vs. Load Current NCP4688xx25

NCP4688

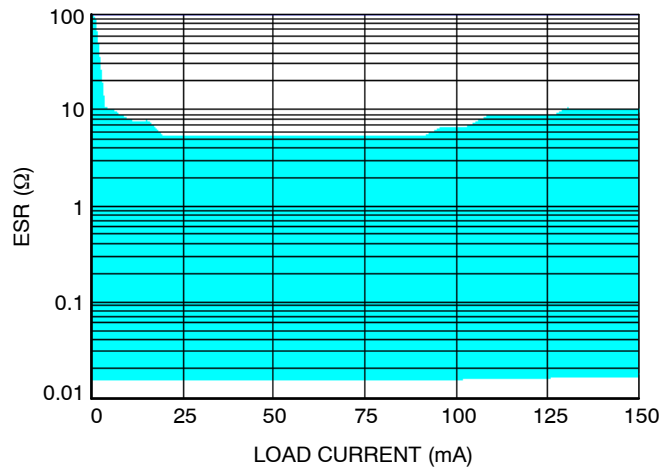

Figure 44. ESR vs. Load Current NCP4688xx40

ORDERING INFORMATION

Device	Marking	Nominal Output Voltage	Feature	Package	Shipping [†]
NCP4688DMU12TCG	3A	1.2 V	Auto discharge	DFN1010 (Pb-Free)	10000 / Tape & Reel
NCP4688DMU15TCG	3E	1.5 V	Auto discharge	DFN1010 (Pb-Free)	10000 / Tape & Reel
NCP4688DMU18TCG	3H	1.8 V	Auto discharge	DFN1010 (Pb-Free)	10000 / Tape & Reel
NCP4688DMU25TCG	3R	2.5 V	Auto discharge	DFN1010 (Pb-Free)	10000 / Tape & Reel
NCP4688DMU28TCG	3U	2.8 V	Auto discharge	DFN1010 (Pb-Free)	10000 / Tape & Reel
NCP4688DMU30TCG	3X	3.0 V	Auto discharge	DFN1010 (Pb-Free)	10000 / Tape & Reel
NCP4688DMU33TCG	4A	3.3 V	Auto discharge	DFN1010 (Pb-Free)	10000 / Tape & Reel
NCP4688DSN12T1G	L12	1.2 V	Auto discharge	SOT-23 (Pb-Free)	3000 / Tape & Reel
NCP4688DSN15T1G	L15	1.5 V	Auto discharge	SOT-23 (Pb-Free)	3000 / Tape & Reel
NCP4688DSN18T1G	L18	1.8 V	Auto discharge	SOT-23 (Pb-Free)	3000 / Tape & Reel
NCP4688DSN25T1G	L25	2.5 V	Auto discharge	SOT-23 (Pb-Free)	3000 / Tape & Reel
NCP4688DSN28T1G	L28	2.8 V	Auto discharge	SOT-23 (Pb-Free)	3000 / Tape & Reel
NCP4688DSN33T1G	L33	3.3 V	Auto discharge	SOT-23 (Pb-Free)	3000 / Tape & Reel

[†]For information on tape and reel specifications, including part orientation and tape sizes, please refer to our Tape and Reel Packaging Specifications Brochure, BRD8011/D.



SCALE 2:1

SOT-23 5-LEAD
CASE 1212
ISSUE A

DATE 28 JAN 2011

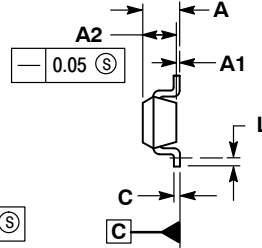
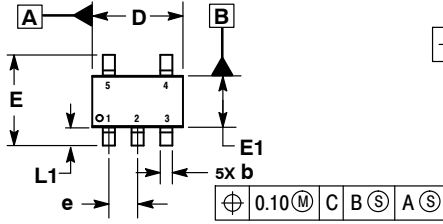

NOTES:

1. DIMENSIONING AND TOLERANCING PER ASME Y14.5M, 1994.
2. CONTROLLING DIMENSIONS: MILLIMETERS.
3. DATUM C IS THE SEATING PLANE.

MILLIMETERS		
DIM	MIN	MAX
A	---	1.45
A1	0.00	0.10
A2	1.00	1.30
b	0.30	0.50
c	0.10	0.25
D	2.70	3.10
E	2.50	3.10
E1	1.50	1.80
e	0.95 BSC	
L	0.20	---
L1	0.45	0.75

RECOMMENDED
SOLDERING FOOTPRINT*

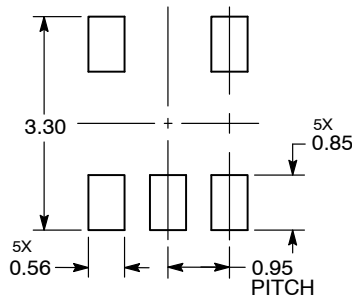

DIMENSIONS: MILLIMETERS

*For additional information on our Pb-Free strategy and soldering details, please download the onsemi Soldering and Mounting Techniques Reference Manual, SOLDERRM/D.

GENERIC
MARKING DIAGRAM*

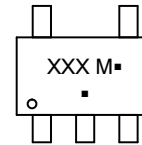

XXX = Specific Device Code

M = Date Code

▪ = Pb-Free Package

(Note: Microdot may be in either location)

*This information is generic. Please refer to device data sheet for actual part marking. Pb-Free indicator, "G" or microdot "▪", may or may not be present.

DOCUMENT NUMBER:	98ASH70518A	Electronic versions are uncontrolled except when accessed directly from the Document Repository. Printed versions are uncontrolled except when stamped "CONTROLLED COPY" in red.
DESCRIPTION:	SOT-23 5-LEAD	PAGE 1 OF 1

onsemi and ONSEMI are trademarks of Semiconductor Components Industries, LLC dba onsemi or its subsidiaries in the United States and/or other countries. onsemi reserves the right to make changes without further notice to any products herein. onsemi makes no warranty, representation or guarantee regarding the suitability of its products for any particular purpose, nor does onsemi assume any liability arising out of the application or use of any product or circuit, and specifically disclaims any and all liability, including without limitation special, consequential or incidental damages. onsemi does not convey any license under its patent rights nor the rights of others.



SCALE 4:1

UDFN4 1.0x1.0, 0.65P
CASE 517BR
ISSUE O

DATE 27 OCT 2010

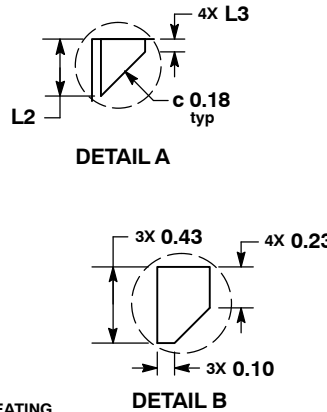
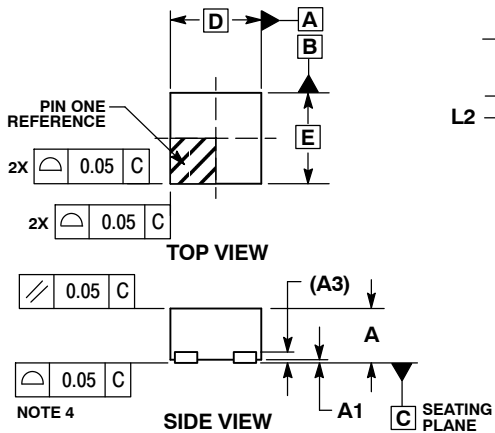

NOTES:

1. DIMENSIONING AND TOLERANCING PER ASME Y14.5M, 1994.
2. CONTROLLING DIMENSION: MILLIMETERS.
3. DIMENSION b APPLIES TO PLATED TERMINAL AND IS MEASURED BETWEEN 0.15 AND 0.20 mm FROM TERMINAL.
4. COPLANARITY APPLIES TO THE EXPOSED PAD AS WELL AS THE TERMINALS.

MILLIMETERS		
DIM	MIN	MAX
A	---	0.60
A1	0.00	0.05
A3	0.10	REF
b	0.20	0.30
D	1.00	BSC
D2	0.43	0.53
E	1.00	BSC
e	0.65	BSC
L	0.20	0.30
L2	0.27	0.37
L3	0.02	0.12

GENERIC MARKING DIAGRAM*

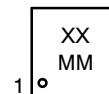

XX = Specific Device Code
MM = Date Code

*This information is generic. Please refer to device data sheet for actual part marking. Pb-Free indicator, "G" or microdot "▪", may or may not be present.

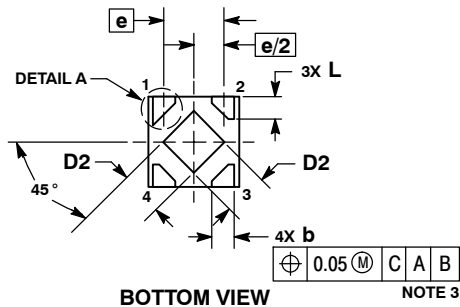

RECOMMENDED MOUNTING FOOTPRINT*

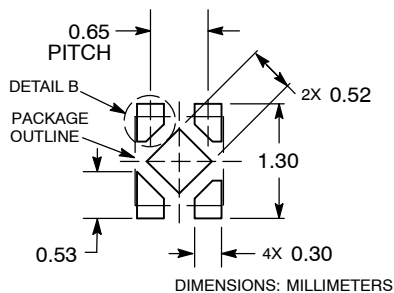

*For additional information on our Pb-Free strategy and soldering details, please download the ON Semiconductor Soldering and Mounting Techniques Reference Manual, SOLDERRM/D.

DOCUMENT NUMBER:	98AON53254E	Electronic versions are uncontrolled except when accessed directly from the Document Repository. Printed versions are uncontrolled except when stamped "CONTROLLED COPY" in red.
DESCRIPTION:	UDFN4 1.0x1.0, 0.65P	PAGE 1 OF 1

onsemi and Onsemi are trademarks of Semiconductor Components Industries, LLC dba onsemi or its subsidiaries in the United States and/or other countries. onsemi reserves the right to make changes without further notice to any products herein. onsemi makes no warranty, representation or guarantee regarding the suitability of its products for any particular purpose, nor does onsemi assume any liability arising out of the application or use of any product or circuit, and specifically disclaims any and all liability, including without limitation special, consequential or incidental damages. onsemi does not convey any license under its patent rights nor the rights of others.

onsemi, **Onsemi**, and other names, marks, and brands are registered and/or common law trademarks of Semiconductor Components Industries, LLC dba "**onsemi**" or its affiliates and/or subsidiaries in the United States and/or other countries. **onsemi** owns the rights to a number of patents, trademarks, copyrights, trade secrets, and other intellectual property. A listing of **onsemi**'s product/patent coverage may be accessed at www.onsemi.com/site/pdf/Patent-Marking.pdf. **onsemi** reserves the right to make changes at any time to any products or information herein, without notice. The information herein is provided "as-is" and **onsemi** makes no warranty, representation or guarantee regarding the accuracy of the information, product features, availability, functionality, or suitability of its products for any particular purpose, nor does **onsemi** assume any liability arising out of the application or use of any product or circuit, and specifically disclaims any and all liability, including without limitation special, consequential or incidental damages. Buyer is responsible for its products and applications using **onsemi** products, including compliance with all laws, regulations and safety requirements or standards, regardless of any support or applications information provided by **onsemi**. "Typical" parameters which may be provided in **onsemi** data sheets and/or specifications can and do vary in different applications and actual performance may vary over time. All operating parameters, including "Typicals" must be validated for each customer application by customer's technical experts. **onsemi** does not convey any license under any of its intellectual property rights nor the rights of others. **onsemi** products are not designed, intended, or authorized for use as a critical component in life support systems or any FDA Class 3 medical devices or medical devices with a same or similar classification in a foreign jurisdiction or any devices intended for implantation in the human body. Should Buyer purchase or use **onsemi** products for any such unintended or unauthorized application, Buyer shall indemnify and hold **onsemi** and its officers, employees, subsidiaries, affiliates, and distributors harmless against all claims, costs, damages, and expenses, and reasonable attorney fees arising out of, directly or indirectly, any claim of personal injury or death associated with such unintended or unauthorized use, even if such claim alleges that **onsemi** was negligent regarding the design or manufacture of the part. **onsemi** is an Equal Opportunity/Affirmative Action Employer. This literature is subject to all applicable copyright laws and is not for resale in any manner.

ADDITIONAL INFORMATION

TECHNICAL PUBLICATIONS:

Technical Library: www.onsemi.com/design/resources/technical-documentation
onsemi Website: www.onsemi.com

ONLINE SUPPORT: www.onsemi.com/support

For additional information, please contact your local Sales Representative at www.onsemi.com/support/sales