

# LP2982 50-mA, Low-Noise, Low-Dropout Regulator in SOT-23 Package

## 1 Features

- $V_{IN}$  range (new chip): 2.5 V to 16 V
- $V_{OUT}$  range (new chip): 1.2 V to 5.0 V
- $V_{OUT}$  accuracy:
  - $\pm 1\%$  for A-grade legacy chip
  - $\pm 1.5\%$  for standard-grade legacy chip
  - $\pm 0.5\%$  for new chip only
- $\pm 1\%$  output accuracy over load, and temperature for new chip
- Output current: Up to 50 mA
- Low  $I_Q$  (new chip): 69  $\mu A$  at  $I_{LOAD} = 0$  mA
- Low  $I_Q$  (new chip): 380  $\mu A$  at  $I_{LOAD} = 50$  mA
- Shutdown current:
  - 1  $\mu A$  for legacy chip
  - 2.25  $\mu A$  for new chip
- Low noise: 30  $\mu V_{RMS}$  with 10-nF bypass capacitor
- Output current limiting and thermal protection
- Stable with 2.2- $\mu F$  ceramic capacitors (new chip)
- High PSRR: 70 dB at 1 kHz, 40 dB at 1 MHz
- Operating junction temperature:  $-40^\circ C$  to  $+125^\circ C$
- Package: 5-pin SOT-23 (DBV)

## 2 Applications

- [Factory automation & control](#)
- [Industrial transport \(non-car & non-light truck\)](#)
- [Grid infrastructure](#)
- [Medical](#)

## 3 Description

The LP2982 is a fixed-output, wide-input, low-noise, low-dropout voltage regulator supporting an input voltage range from 2.5 V to 16 V (for new chip) and up to 50 mA of load current. The LP2982 supports an output range of 1.2 V to 5.0 V (for new chip).

Additionally, the LP2982 (new chip) has a 1% output accuracy across load, and temperature that can meet the needs of low-voltage microcontrollers (MCUs) and processors.

Low output noise of 30  $\mu V_{RMS}$  (with 10-nF bypass capacitors) and wide bandwidth PSRR performance of greater than 70 dB at 1 kHz and 40 dB at 1 MHz help attenuate the switching frequency of an upstream DC/DC converter and minimize post regulator filtering.

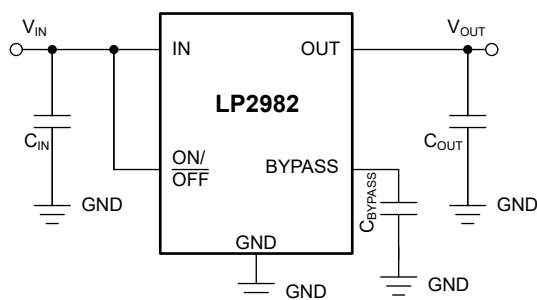
The internal soft-start time and current limit protection reduce inrush current during start up, thus minimizing input capacitance. Standard protection features, such as overcurrent and overtemperature protection, are included.

The LP2982 is available in a 5-pin 2.9-mm  $\times$  2.8-mm SOT-23 (DBV) package.

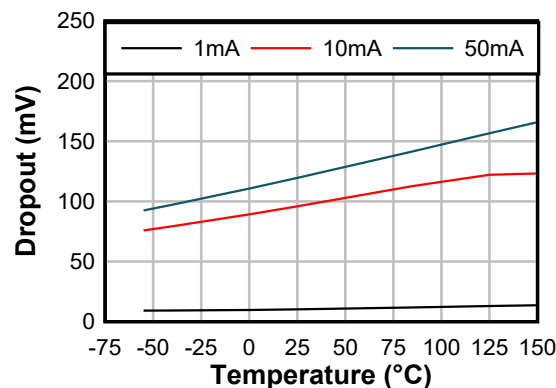
### Device Information

| PART NUMBER | PACKAGE <sup>(1)</sup> | BODY SIZE (NOM) <sup>(2)</sup> |
|-------------|------------------------|--------------------------------|
| LP2982      | SOT-23 (5)             | 2.90 mm $\times$ 2.80 mm       |

- (1) For all available packages, see the orderable addendum at the end of the data sheet.
- (2) The package size (length  $\times$  width) is a nominal value and includes pins, where applicable.



Simplified Schematic



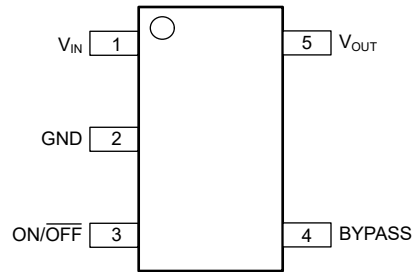
Dropout Voltage versus Temperature (New Chip)



## Table of Contents

|  |    |  |    |
|--|----|--|----|
| <b>1 Features</b> .....                        | 1  | 7.2 Typical Application.....                                     | 25 |
| <b>2 Applications</b> .....                    | 1  | <b>8 Power Supply Recommendations</b> .....                      | 29 |
| <b>3 Description</b> .....                     | 1  | <b>9 Layout</b> .....  | 29 |
| <b>4 Pin Configuration and Functions</b> ..... | 3  | 9.1 Layout Guidelines.....                                       | 29 |
| <b>5 Specifications</b> .....                  | 4  | 9.2 Layout Example.....  | 29 |
| 5.1 Absolute Maximum Ratings.....              | 4  | <b>10 Device and Documentation Support</b> .....                 | 30 |
| 5.2 ESD Ratings.....                           | 4  | 10.1 Device Nomenclature.....                                    | 30 |
| 5.3 Recommended Operating Conditions.....      | 4  | 10.2 Third-Party Products Disclaimer.....                        | 30 |
| 5.4 Thermal Information.....                   | 5  | 10.3 Documentation Support.....                                  | 30 |
| 5.5 Electrical Characteristics.....            | 5  | 10.4 Receiving Notification of Documentation Updates..           | 30 |
| 5.6 Typical Characteristics.....               | 8  | 10.5 Support Resources.....                                      | 30 |
| <b>6 Detailed Description</b> .....            | 18 | 10.6 Trademarks.....   | 30 |
| 6.1 Overview.....                              | 18 | 10.7 Electrostatic Discharge Caution.....                        | 30 |
| 6.2 Functional Block Diagram.....              | 18 | 10.8 Glossary.....   | 30 |
| 6.3 Feature Description.....                   | 18 | <b>11 Revision History</b> .....                                 | 31 |
| 6.4 Device Functional Modes.....               | 20 | <b>12 Mechanical, Packaging, and Orderable Information</b> ..... | 31 |
| <b>7 Application and Implementation</b> .....  | 22 |  |    |
| 7.1 Application Information.....               | 22 |  |    |

## 4 Pin Configuration and Functions



**Figure 4-1. DBV Package, 5-Pin SOT-23 (Top View)**

**Table 4-1. Pin Functions**

| PIN       |     | TYPE | DESCRIPTION  |
|-----------|-----|------|--|
| NAME      | NO. |      |  |
| BYPASS    | 4   | I/O  | BYPASS pin to achieve low noise performance. Connecting an external capacitor between BYPASS pin and ground reduces reference voltage noise. See the <a href="#">Section 5.3</a> section for more information.                     |
| GND       | 2   | —    | Ground   |
| ON/OFF    | 3   | I    | Enable pin for the LDO. Driving the ON/OFF pin high enables the device. Driving this pin low disables the device. High and low thresholds are listed in the <a href="#">Section 5.5</a> table. Tie this pin to $V_{IN}$ if unused. |
| $V_{IN}$  | 1   | I    | Input supply pin. Use a capacitor with a value of 1 $\mu\text{F}$ or larger from this pin to ground. See the <a href="#">Section 7.1.2</a> section for more information.   |
| $V_{OUT}$ | 5   | O    | Output of the regulator. Use a capacitor with a value of 2.2 $\mu\text{F}$ or larger from this pin to ground. See the <a href="#">Section 7.1.2</a> section for more information.  |

## 5 Specifications

### 5.1 Absolute Maximum Ratings

over operating free-air temperature range (unless otherwise noted)

|                    |  | MIN                | MAX   | UNIT |
|--------------------|--|--------------------|---|------|
| $V_{IN}$           | Continuous input voltage range (for legacy chip) | -0.3               | 16  | V    |
|                    | Continuous input voltage range (for new chip)    | -0.3               | 18  |      |
| $V_{OUT}$          | Output voltage range (for legacy chip)           | -0.3               | 9   |      |
|                    | Output voltage range (for new chip)              | -0.3               | $V_{IN} + 0.3$ or 9<br>(whichever is smaller) |      |
| $V_{ON/OFF}$       | ON/OFF pin voltage range (for legacy chip)       | -0.3               | 16  |      |
|                    | ON/OFF pin voltage range (for new chip)          | -0.3               | 18  |      |
| $V_{IN} - V_{OUT}$ | Input-output voltage (for legacy chip)           | -0.3               | 16  |      |
|                    | Input-output voltage (for new chip)              | -0.3               | 18  |      |
| Current            | Maximum output current                           | Internally limited |   | mA   |
| Temperature        | Operating junction, $T_J$                        | -55                | 150   | °C   |
|                    | Storage, $T_{stg}$                               | -65                | 150   |      |

### 5.2 ESD Ratings

|             |                         |   | VALUE<br>(Legacy<br>Chip) | VALUE<br>(New<br>Chip) | UNIT |
|-------------|-------------------------|---|---------------------------|------------------------|------|
| $V_{(ESD)}$ | Electrostatic discharge | Human body model (HBM), per ANSI/ESDA/JEDEC JS-001 (Pin 1,2 and 5) <sup>(1)</sup> | ±2000                     | ±3000                  | V    |
|             |                         | Human body model (HBM), per ANSI/ESDA/JEDEC JS-001 (Pin 3 and 4) <sup>(1)</sup>   | ±1000                     |                        |      |
|             |                         | Charged device model (CDM), per JEDEC specification JESD22-C101 <sup>(2)</sup>    | N/A                       | ±1000                  |      |

(1) JEDEC document JEP155 states that 2-kV HBM allows safe manufacturing with a standard ESD control process.

(2) JEDEC document JEP157 states that 500-V CDM allows safe manufacturing with a standard ESD control process.

### 5.3 Recommended Operating Conditions

|                         |  | MIN | NOM | MAX      | UNIT |
|-------------------------|--|-----|-----|----------|------|
| $V_{IN}$                | Supply input voltage (for legacy chip)           | 2.1 |     | 16       | V    |
|                         | Supply input voltage (for new chip)              | 2.5 |     | 16       |      |
| $V_{IN} - V_{OUT}$      | Input-output differential (for legacy chip)      | 0.7 |     | 11       |      |
|                         | Input-output differential (for new chip)         | 0   |     | 16       |      |
| $V_{OUT}$               | Output voltage (for new chip)                    | 1.2 |     | 5        |      |
| $V_{ON/OFF}$            | Enable voltage (for legacy chip)                 | 0   |     | $V_{IN}$ |      |
|                         | Enable voltage (for new chip)                    | 0   |     | 16       |      |
| $I_{OUT}$               | Output current                                   | 0   |     | 50       |      |
| $C_{IN}$ <sup>(1)</sup> | Input capacitor                                  |     | 1   |          | μF   |
| $C_{OUT}$               | Output capacitor (for legacy chip)               | 2.2 | 4.7 |          |      |
|                         | Output capacitance (for new chip) <sup>(1)</sup> | 1   | 2.2 | 200      |      |
| $T_J$                   | Operating junction temperature                   | -40 |     | 125      | °C   |

(1) All capacitor values are assumed to derate to 50% of the nominal capacitor value. Maintain an effective output capacitance of 1 μF minimum for stability.

## 5.4 Thermal Information

| THERMAL METRIC <sup>(1)</sup> |  | Legacy Chip <sup>(2)</sup> | New Chip <sup>(2)</sup> | UNIT |
|-------------------------------|--|----------------------------|-------------------------|------|
|                               |  | DBV (SOT23-5)              | DBV (SOT23-5)           |      |
|                               |  | 5 PINS                     | 5 PINS                  |      |
| R <sub>θJA</sub>              | Junction-to-ambient thermal resistance       | 175.7                      | 178.6                   | °C/W |
| R <sub>θJC(top)</sub>         | Junction-to-case (top) thermal resistance    | 121.8                      | 77.9                    | °C/W |
| R <sub>θJB</sub>              | Junction-to-board thermal resistance         | 29.5                       | 47.2                    | °C/W |
| ψ <sub>JT</sub>               | Junction-to-top characterization parameter   | 16.1                       | 15.9                    | °C/W |
| ψ <sub>JB</sub>               | Junction-to-board characterization parameter | 29.0                       | 46.9                    | °C/W |

- (1) For more information about traditional and new thermal metrics, see the [Semiconductor and IC Package Thermal Metrics](#) application note.
- (2) Thermal performance results are based on the JEDEC standard of 2s2p PCB configuration. These thermal metric parameters can be further improved by 35-55% based on thermally optimized PCB layout designs. See the analysis of the [Impact of board layout on LDO thermal performance](#) application report.

## 5.5 Electrical Characteristics

specified at T<sub>J</sub> = 25 °C, V<sub>IN</sub> = V<sub>OUT(nom)</sub> + 1.0 V or V<sub>IN</sub> = 2.5 V (whichever is greater), I<sub>OUT</sub> = 1 mA, V<sub>ON/OFF</sub> = 2 V, C<sub>IN</sub> = 1.0 μF, and C<sub>OUT</sub> = 2.2 μF (unless otherwise noted)

| PARAMETER                 |                          | TEST CONDITIONS  |                              | MIN   | TYP | MAX   | UNIT |
|---------------------------|--------------------------|--|------------------------------|-------|-----|-------|------|
| ΔV <sub>OUT</sub>         | Output voltage tolerance | I <sub>L</sub> = 1 mA  | Legacy chip (standard grade) | -1.5  |     | 1.5   | %    |
|                           |                          |  | Legacy chip (A grade)        | -1.0  |     | 1.0   |      |
|                           |                          |  | New chip                     | -0.5  |     | 0.5   |      |
|                           |                          | 1 mA < I <sub>L</sub> < 50 mA  | Legacy chip (standard grade) | -2    |     | 2     |      |
|                           |                          |  | Legacy chip (A grade)        | -1.5  |     | 1.5   |      |
|                           |                          |  | New chip                     | -0.5  |     | 0.5   |      |
|                           |                          | 1 mA < I <sub>L</sub> < 50 mA, -40°C ≤ T <sub>J</sub> ≤ 125°C  | Legacy chip (standard grade) | -3.5  |     | 3.5   |      |
|                           |                          |  | Legacy chip (A grade)        | -2    |     | 2     |      |
|                           |                          |  | New chip                     | -1    |     | 1     |      |
| ΔV <sub>OUT(ΔVIN)</sub>   | Line regulation          | V <sub>O(NOM)</sub> + 1 V < V <sub>IN</sub> < 16 V   | Legacy chip                  | 0.007 |     | 0.014 | %V   |
|                           |                          |  | New chip                     | 0.002 |     | 0.014 |      |
|                           |                          | V <sub>O(NOM)</sub> + 1 V < V <sub>IN</sub> < 16 V, -40°C ≤ T <sub>J</sub> ≤ 125°C                           | Legacy chip                  | 0.007 |     | 0.032 |      |
|                           |                          |  | New chip                     | 0.002 |     | 0.032 |      |
| ΔV <sub>OUT(ΔILOAD)</sub> | Load regulation          | 1 mA < I <sub>L</sub> < 50 mA, -40°C ≤ T <sub>J</sub> ≤ 125°C, V <sub>IN</sub> = V <sub>O(NOM)</sub> + 0.5 V | New chip                     |       | 0.1 | 0.5   | %/A  |

specified at  $T_J = 25\text{ }^\circ\text{C}$ ,  $V_{IN} = V_{OUT(nom)} + 1.0\text{ V}$  or  $V_{IN} = 2.5\text{ V}$  (whichever is greater),  $I_{OUT} = 1\text{ mA}$ ,  $V_{ON/OFF} = 2\text{ V}$ ,  $C_{IN} = 1.0\text{ }\mu\text{F}$ , and  $C_{OUT} = 2.2\text{ }\mu\text{F}$  (unless otherwise noted)

| PARAMETER   |                                | TEST CONDITIONS   |             | MIN  | TYP           | MAX  | UNIT          |               |
|---|--------------------------------|---|-------------|------|---------------|------|---------------|---------------|
| V <sub>DO</sub>   | Dropout voltage <sup>(1)</sup> | I <sub>OUT</sub> = 0 mA   | Legacy chip |      | 1             | 3    | mV            |               |
|   |                                |   | New chip    |      | 1             | 2.75 |               |               |
|   |                                | I <sub>OUT</sub> = 0 mA, $-40\text{ }^\circ\text{C} \leq T_J \leq 125\text{ }^\circ\text{C}$  | Legacy chip |      |               | 5    |               |               |
|   |                                |   | New chip    |      |               | 3    |               |               |
|   |                                | I <sub>OUT</sub> = 1 mA   | Legacy chip |      | 7             | 10   |               |               |
|   |                                |   | New chip    |      | 11.5          | 14   |               |               |
|   |                                | I <sub>OUT</sub> = 1 mA, $-40\text{ }^\circ\text{C} \leq T_J \leq 125\text{ }^\circ\text{C}$  | Legacy chip |      |               | 15   |               |               |
|   |                                |   | New chip    |      |               | 17   |               |               |
|   |                                | I <sub>OUT</sub> = 10 mA  | Legacy chip |      | 40            | 60   |               |               |
|   |                                |   | New chip    |      | 98            | 115  |               |               |
|   |                                | I <sub>OUT</sub> = 10 mA, $-40\text{ }^\circ\text{C} \leq T_J \leq 125\text{ }^\circ\text{C}$ | Legacy chip |      |               | 90   |               |               |
|   |                                |   | New chip    |      |               | 148  |               |               |
|   |                                | I <sub>OUT</sub> = 50 mA  | Legacy chip |      | 120           | 150  |               |               |
|   |                                |   | New chip    |      | 120           | 145  |               |               |
|   |                                | I <sub>OUT</sub> = 50 mA, $-40\text{ }^\circ\text{C} \leq T_J \leq 125\text{ }^\circ\text{C}$ | Legacy chip |      |               | 225  |               |               |
|   |                                |   | New chip    |      |               | 184  |               |               |
| I <sub>OUT</sub> = 80 mA  | Legacy chip                    |   | 180         | 225  |               |      |               |               |
|   | New chip                       |   | 150         | 165  |               |      |               |               |
| I <sub>OUT</sub> = 80 mA, $-40\text{ }^\circ\text{C} \leq T_J \leq 125\text{ }^\circ\text{C}$                             | Legacy chip                    |   |             | 325  |               |      |               |               |
|   | New chip                       |   |             | 204  |               |      |               |               |
| I <sub>GND</sub>  | GND pin current                | I <sub>OUT</sub> = 0 mA   | Legacy chip |      | 65            | 95   | $\mu\text{A}$ |               |
|   |                                |   | New chip    |      | 69            | 95   |               |               |
|   |                                | I <sub>OUT</sub> = 0 mA, $-40\text{ }^\circ\text{C} \leq T_J \leq 125\text{ }^\circ\text{C}$  | Legacy chip |      |               | 125  |               |               |
|   |                                |   | New chip    |      |               | 123  |               |               |
|   |                                | I <sub>OUT</sub> = 1 mA   | Legacy chip |      | 80            | 110  |               |               |
|   |                                |   | New chip    |      | 78            | 110  |               |               |
|   |                                | I <sub>OUT</sub> = 1 mA, $-40\text{ }^\circ\text{C} \leq T_J \leq 125\text{ }^\circ\text{C}$  | Legacy chip |      |               | 170  |               |               |
|   |                                |   | New chip    |      |               | 140  |               |               |
|   |                                | I <sub>OUT</sub> = 10 mA  | Legacy chip |      | 140           | 220  |               | $\mu\text{A}$ |
|   |                                |   | New chip    |      | 175           | 210  |               |               |
|   |                                | I <sub>OUT</sub> = 10 mA, $-40\text{ }^\circ\text{C} \leq T_J \leq 125\text{ }^\circ\text{C}$ | Legacy chip |      |               | 460  |               |               |
|   |                                |   | New chip    |      |               | 250  |               |               |
|   |                                | I <sub>OUT</sub> = 50 mA  | Legacy chip |      | 375           | 600  |               | $\mu\text{A}$ |
|   |                                |   | New chip    |      | 380           | 440  |               | $\mu\text{A}$ |
|   |                                | I <sub>OUT</sub> = 50 mA, $-40\text{ }^\circ\text{C} \leq T_J \leq 125\text{ }^\circ\text{C}$ | Legacy chip |      |               | 1200 |               | $\mu\text{A}$ |
|   |                                |   | New chip    |      |               | 650  |               | $\mu\text{A}$ |
|   |                                | I <sub>OUT</sub> = 80 mA  | Legacy chip |      | 525           | 750  |               | $\mu\text{A}$ |
|   |                                |   | New chip    |      | 575           | 720  |               | $\mu\text{A}$ |
|   |                                | I <sub>OUT</sub> = 80 mA, $-40\text{ }^\circ\text{C} \leq T_J \leq 125\text{ }^\circ\text{C}$ | Legacy chip |      |               | 1400 |               | $\mu\text{A}$ |
|   |                                |   |             |      |               | 900  |               | $\mu\text{A}$ |
| V <sub>ON/OFF</sub> < 0.3 V, V <sub>IN</sub> = 16 V   | Legacy chip                    |   | 0.01        | 0.8  | $\mu\text{A}$ |      |               |               |
|   | New chip                       |   | 1.25        | 1.75 | $\mu\text{A}$ |      |               |               |
| V <sub>ON/OFF</sub> < 0.15 V, V <sub>IN</sub> = 16 V, $-40\text{ }^\circ\text{C} \leq T_J \leq 125\text{ }^\circ\text{C}$ | Legacy chip                    |   | 0.1         | 2    | $\mu\text{A}$ |      |               |               |
|   | New chip                       |   | 1.12        | 2.75 | $\mu\text{A}$ |      |               |               |

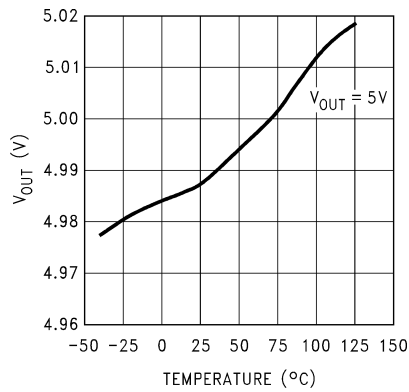
specified at  $T_J = 25^\circ\text{C}$ ,  $V_{IN} = V_{OUT(nom)} + 1.0\text{ V}$  or  $V_{IN} = 2.5\text{ V}$  (whichever is greater),  $I_{OUT} = 1\text{ mA}$ ,  $V_{ON/OFF} = 2\text{ V}$ ,  $C_{IN} = 1.0\text{ }\mu\text{F}$ , and  $C_{OUT} = 2.2\text{ }\mu\text{F}$  (unless otherwise noted)

| PARAMETER                  |                            | TEST CONDITIONS   | MIN         | TYP   | MAX  | UNIT                |
|----------------------------|----------------------------|---|-------------|-------|------|---------------------|
| $V_{UVLO+}$                | Rising bias supply UVLO    | $V_{IN}$ rising, $-40^\circ\text{C} \leq T_J \leq 125^\circ\text{C}$  |             | 2.2   | 2.4  | V                   |
| $V_{UVLO-}$                | Falling bias supply UVLO   | $V_{IN}$ falling, $-40^\circ\text{C} \leq T_J \leq 125^\circ\text{C}$   | New chip    | 1.9   |      | V                   |
| $V_{UVLO(HYST)}$           | UVLO hysteresis            | $-40^\circ\text{C} \leq T_J \leq 125^\circ\text{C}$   |             | 0.130 |      | V                   |
| $I_{O(MAX)}$               | Short Output Current       | $R_L = 0\text{ }\Omega$ (steady state)  | Legacy chip | 150   |      | mA                  |
|                            |                            |   | New chip    | 150   |      | mA                  |
| $I_{O(PK)}$                | Peak Output Current        | $V_{OUT} \geq V_{O(NOM)} - 5\%$ (steady state)  | Legacy chip | 100   | 150  | mA                  |
|                            |                            |   | New chip    | 100   | 150  | mA                  |
| $V_{ON/OFF}$               | ON/OFF input voltage       | Low = Output OFF  | Legacy chip | 0.55  |      | V                   |
|                            |                            |   | New chip    | 0.72  |      |                     |
|                            |                            | Low = Output OFF, $V_{OUT} + 1 < V_{IN} < 16\text{ V}$ , $-40^\circ\text{C} \leq T_J \leq 125^\circ\text{C}$  | Legacy chip |       | 0.15 |                     |
|                            |                            |   | New chip    |       | 0.15 |                     |
|                            |                            | High = Output ON  | Legacy chip | 1.4   |      |                     |
|                            |                            |   | New chip    | 0.85  |      |                     |
|                            |                            | High = Output ON, $V_{OUT} + 1 < V_{IN} < 16\text{ V}$ , $-40^\circ\text{C} \leq T_J \leq 125^\circ\text{C}$  | Legacy chip | 1.6   |      |                     |
|                            |                            |   | New chip    | 1.6   |      |                     |
| $I_{ON/OFF}$               | ON/OFF input current       | $V_{ON/OFF} = 0\text{ V}$   | Legacy chip | 0.01  |      | $\mu\text{A}$       |
|                            |                            |   | New chip    | 0.42  |      |                     |
|                            |                            | $V_{ON/OFF} = 0\text{ V}$ , $V_{OUT} + 1 < V_{IN} < 16\text{ V}$ , $-40^\circ\text{C} \leq T_J \leq 125^\circ\text{C}$                                | Legacy chip |       | -2   | $\mu\text{A}$       |
|                            |                            |   | New chip    |       | -0.9 | $\mu\text{A}$       |
|                            |                            | $V_{ON/OFF} = 5\text{ V}$   | Legacy chip | 5     |      | $\mu\text{A}$       |
|                            |                            |   | New chip    | 0.011 |      | $\mu\text{A}$       |
|                            |                            | $V_{ON/OFF} = 5\text{ V}$ , $V_{OUT} + 1 < V_{IN} < 16\text{ V}$ , $-40^\circ\text{C} \leq T_J \leq 125^\circ\text{C}$                                | Legacy chip | 15    |      | $\mu\text{A}$       |
|                            |                            |   | New chip    | 2.20  |      | $\mu\text{A}$       |
| $\Delta V_O/\Delta V_{IN}$ | Ripple rejection           | $f = 1\text{ kHz}$ , $C_{BYPASS} = 10\text{ nF}$ , $C_{OUT} = 10\text{ }\mu\text{F}$  | Legacy chip | 45    |      | dB                  |
|                            |                            |   | New chip    | 78    |      |                     |
|                            |                            | $f = 100\text{ kHz}$ , $C_{BYPASS} = 10\text{ nF}$ , $I_{LOAD} = 50\text{ mA}$  | Legacy chip | 45    |      | dB                  |
|                            |                            |   | New chip    |       |      |                     |
| $V_n$                      | Output noise voltage       | Bandwidth = 300 Hz to 50 kHz, $C_{NR/SS} = 10\text{ nF}$ , $C_{OUT} = 2.2\text{ }\mu\text{F}$ , $V_{OUT} = 1.8\text{ V}$ , $I_{LOAD} = 150\text{ mA}$ | Legacy chip | 30    |      | $\mu\text{V}_{RMS}$ |
|                            |                            |   | New chip    | 30    |      |                     |
|                            |                            | Bandwidth = 10 Hz to 100 kHz, $C_{NR/SS} = 10\text{ nF}$ , $C_{OUT} = 2.2\text{ }\mu\text{F}$ , $V_{OUT} = 3.3\text{ V}$ , $I_{LOAD} = 150\text{ mA}$ | Legacy chip | 50    |      |                     |
|                            |                            |   | New chip    | 50    |      |                     |
| $T_{sd+}$                  | Thermal shutdown threshold | Shutdown, temperature increasing  |             | 170   |      | $^\circ\text{C}$    |
| $T_{sd-}$                  |                            | Reset, temperature decreasing   |             | 150   |      |                     |

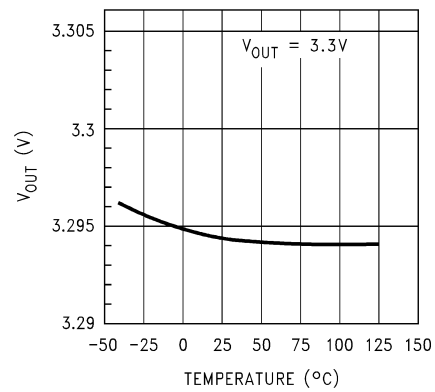
- (1) Dropout voltage ( $V_{DO}$ ) is defined as the input-to-output differential at which the output voltage drops 100 mV below the value measured with a 1 V differential.  $V_{DO}$  is measured with  $V_{IN} = V_{OUT(nom)} - 100\text{ mV}$  for fixed output devices.

### 5.6 Typical Characteristics

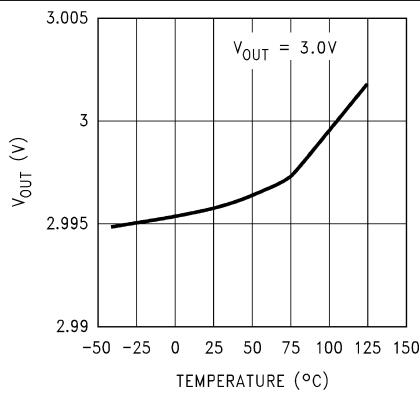
Unless otherwise specified:  $T_A = 25^\circ\text{C}$ ,  $V_{IN} = V_{O(NOM)} + 1\text{ V}$ ,  $C_{OUT} = 4.7\ \mu\text{F}$ ,  $C_{IN} = 1\ \mu\text{F}$ , all voltage options, ON/OFF pin tied to  $V_{IN}$ .



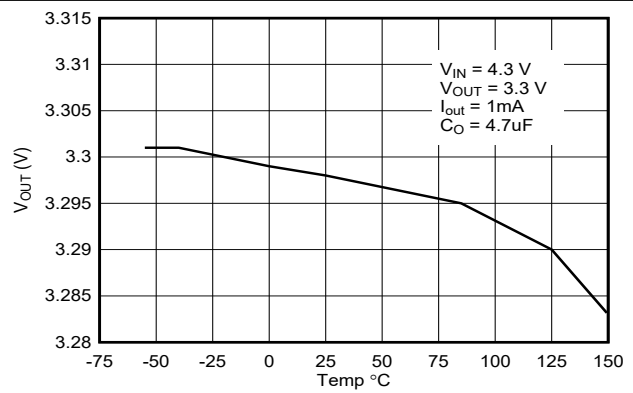
**Figure 5-1. Output Voltage versus Temperature (Legacy Chip)**



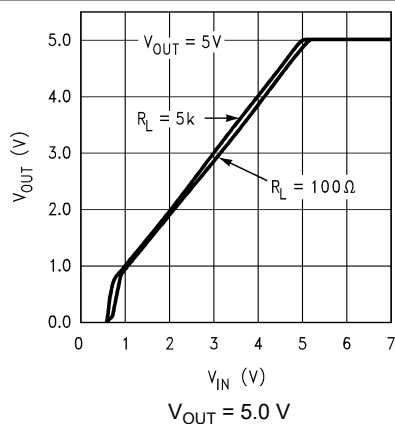
**Figure 5-2. Output Voltage versus Temperature (Legacy Chip)**



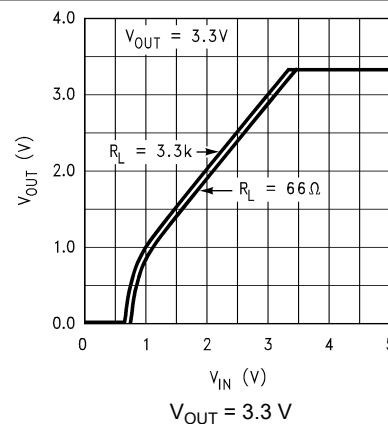
**Figure 5-3. Output Voltage versus Temperature (Legacy Chip)**



**Figure 5-4. Output Voltage versus Temperature (New Chip)**



**Figure 5-5. Output Voltage versus  $V_{IN}$  (Legacy Chip)**



**Figure 5-6. Output Voltage versus  $V_{IN}$  (Legacy Chip)**



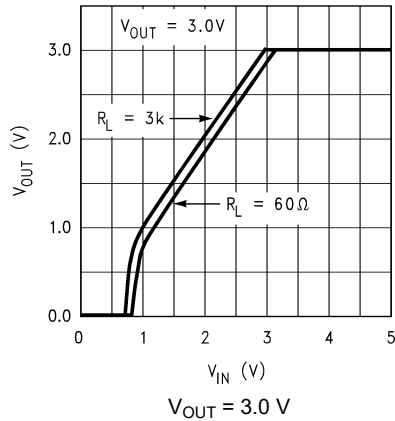


Figure 5-7. Output Voltage versus  $V_{IN}$  (Legacy Chip)

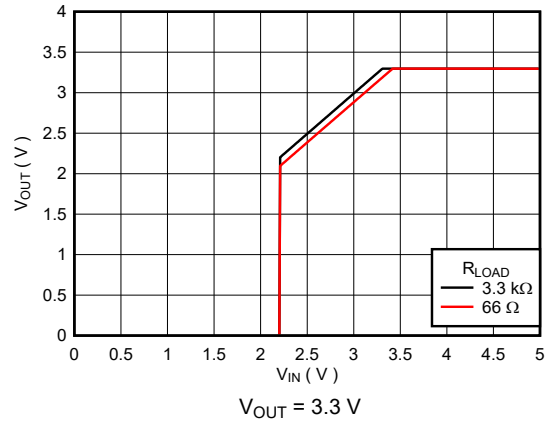


Figure 5-8. Output Voltage versus  $V_{IN}$  (New Chip)

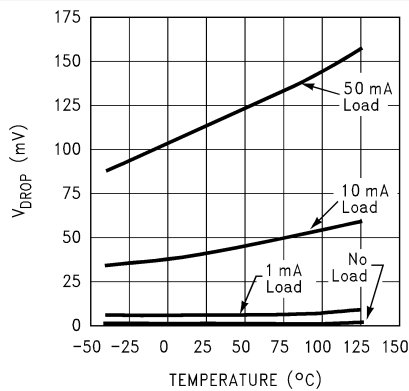


Figure 5-9. Dropout Voltage versus Temperature (Legacy Chip)

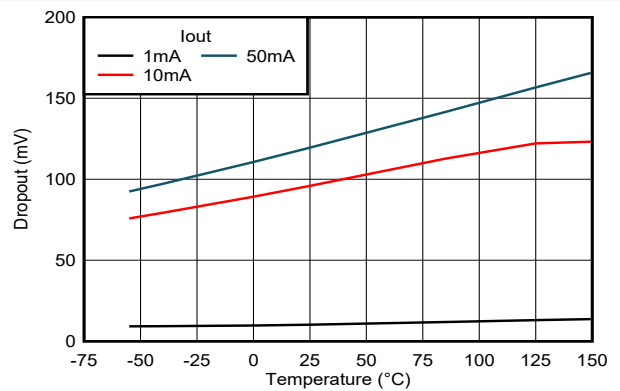


Figure 5-10. Dropout Voltage versus Temperature (New Chip)

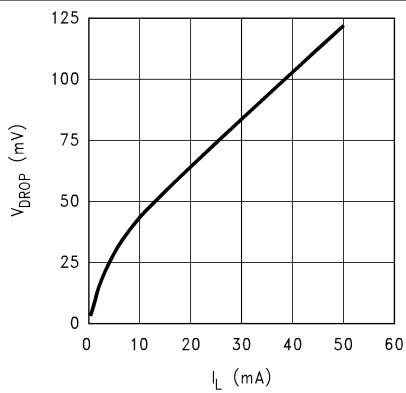


Figure 5-11. Dropout Voltage versus Load Current (Legacy Chip)

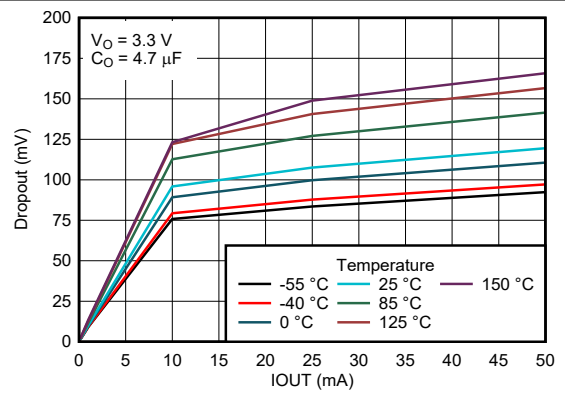
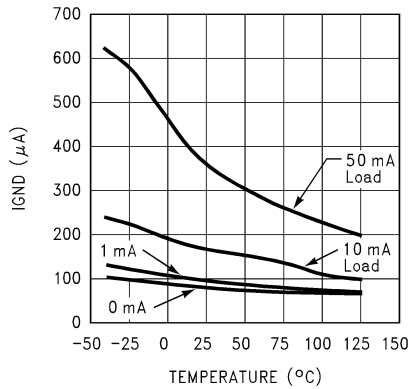
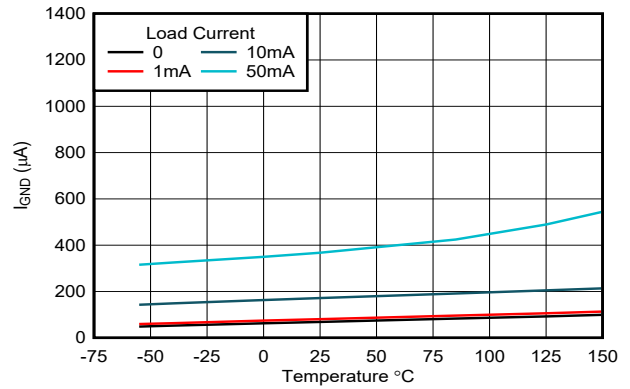


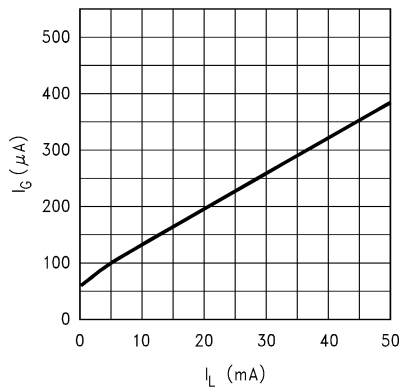
Figure 5-12. Dropout Voltage versus Load Current (New Chip)



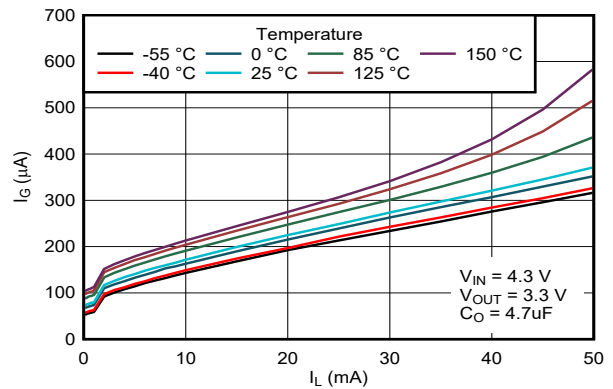
**Figure 5-13. Ground Pin Current versus Temperature (Legacy Chip)**



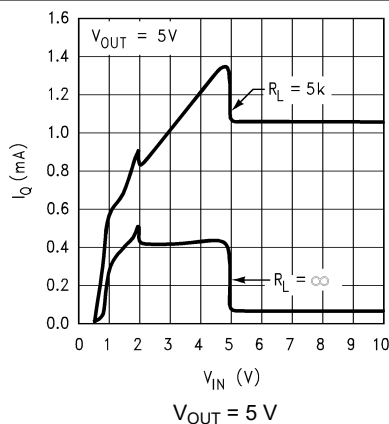
**Figure 5-14. Ground Pin Current versus Temperature (New Chip)**



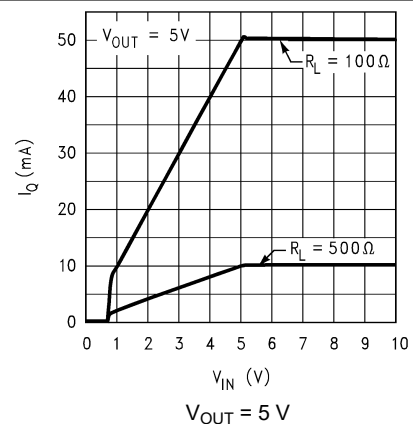
**Figure 5-15. Ground Pin Current versus Load Current (Legacy Chip)**



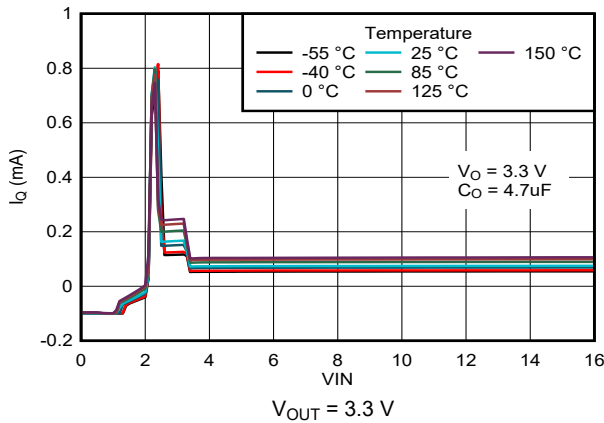
**Figure 5-16. Ground Pin Current versus Load Current (New Chip)**



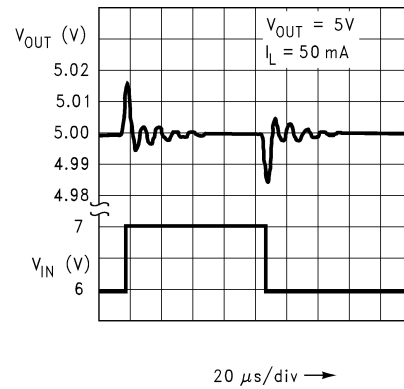
**Figure 5-17. Input Current versus VIN (Legacy Chip)**



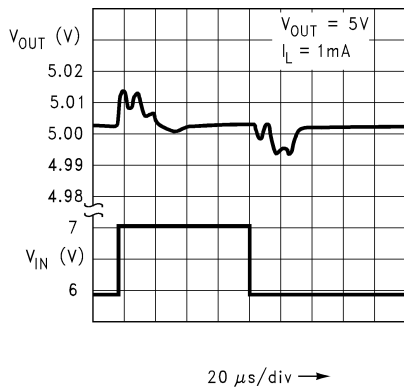
**Figure 5-18. Input Current versus VIN (Legacy Chip)**



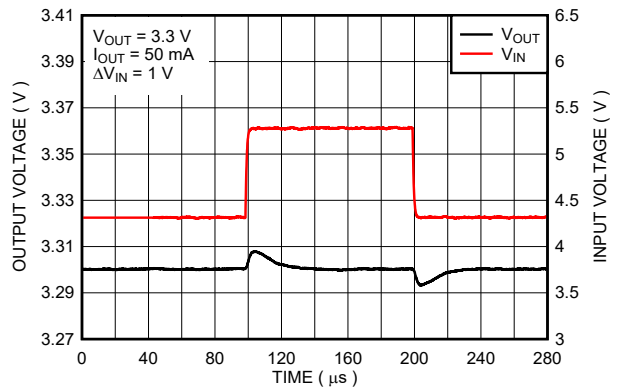
**Figure 5-19. Input Current versus Input Voltage (New Chip)**



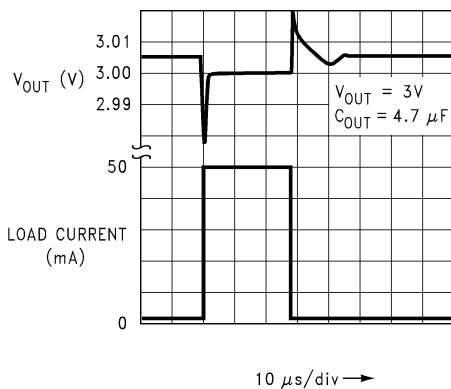
**Figure 5-20. Line Transient Response (Legacy chip)**



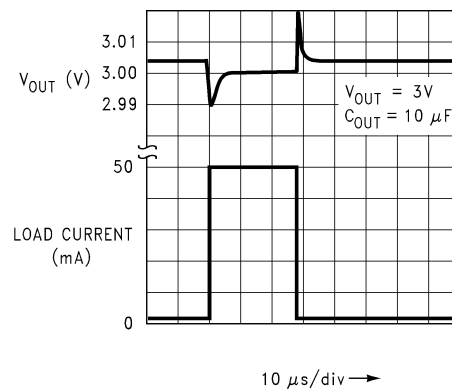
**Figure 5-21. Line Transient Response (Legacy chip)**



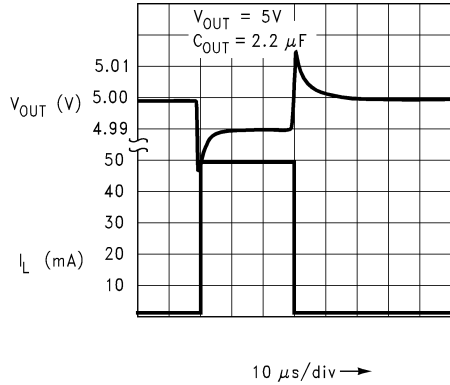
**Figure 5-22. Line Transient Response (New Chip)**



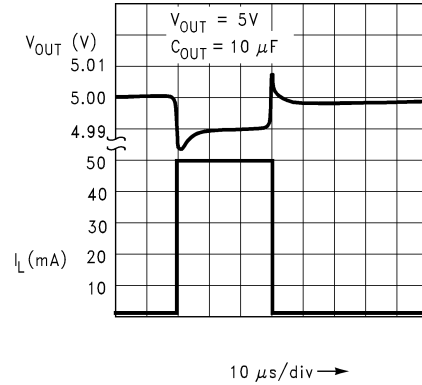
**Figure 5-23. Load Transient Response (Legacy chip)**



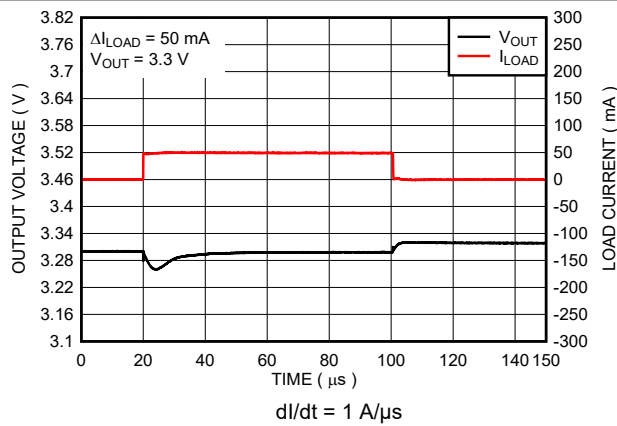
**Figure 5-24. Load Transient Response (Legacy chip)**



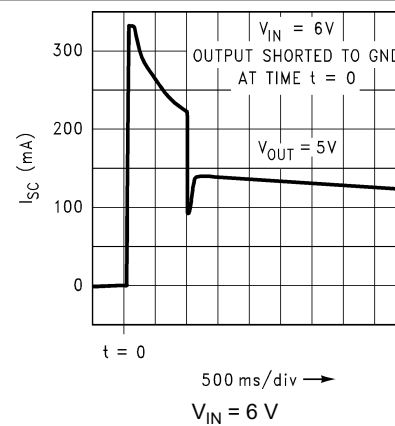
**Figure 5-25. Load Transient Response (Legacy chip)**



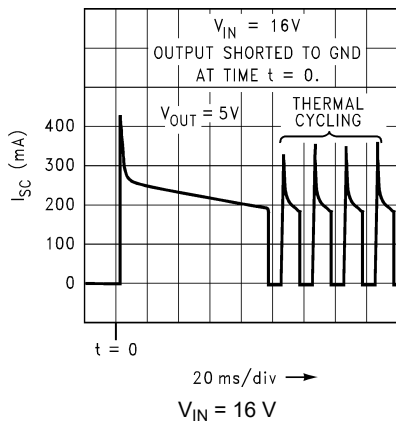
**Figure 5-26. Load Transient Response (Legacy chip)**



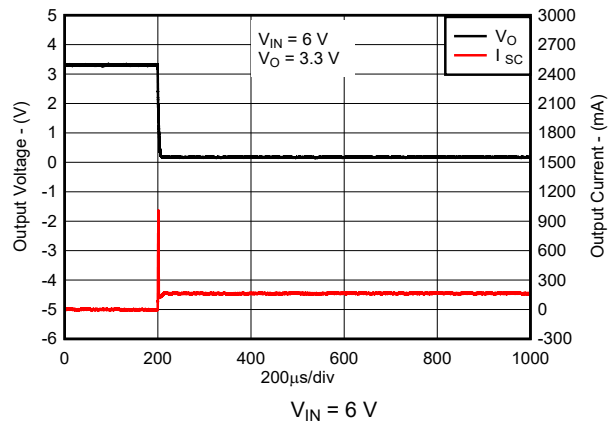
**Figure 5-27. Load Transient Response (New Chip)**



**Figure 5-28. Short-Circuit Current versus Time (Legacy chip)**



**Figure 5-29. Short-Circuit Current versus Time (Legacy chip)**



**Figure 5-30. Short-Circuit Current versus Time (New Chip)**

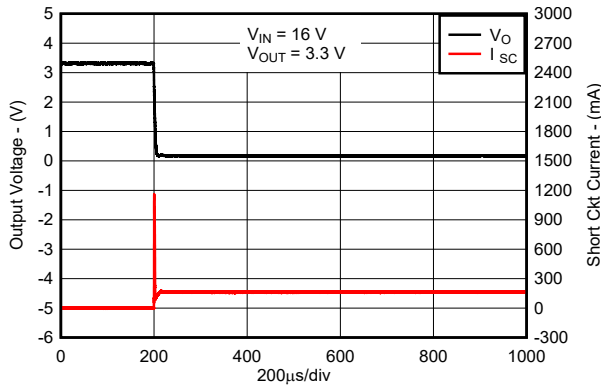


Figure 5-31. Short-Circuit Current versus Time (New Chip)

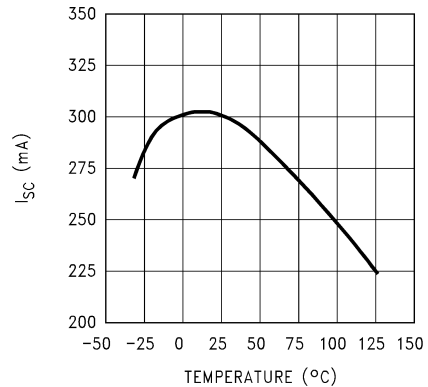


Figure 5-32. Instantaneous Short-Circuit Current versus Temperature (Legacy chip)

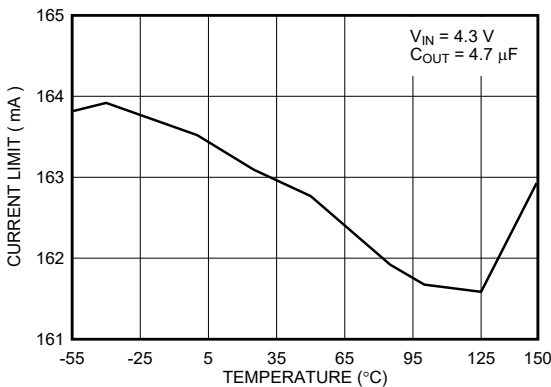


Figure 5-33. Short-Circuit Current versus Temperature (New Chip)

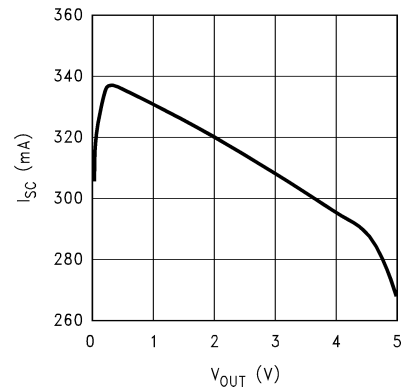


Figure 5-34. Instantaneous Short Circuit Current versus Output Voltage (Legacy chip)

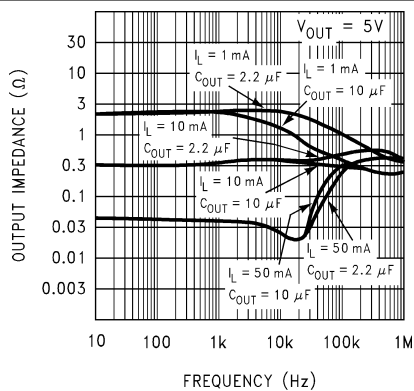


Figure 5-35. Output Impedance versus Frequency (Legacy chip)

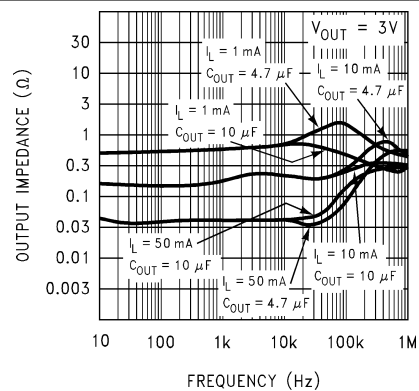
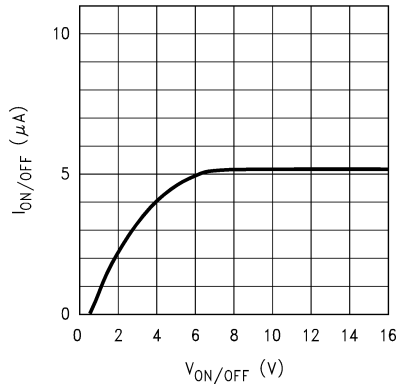
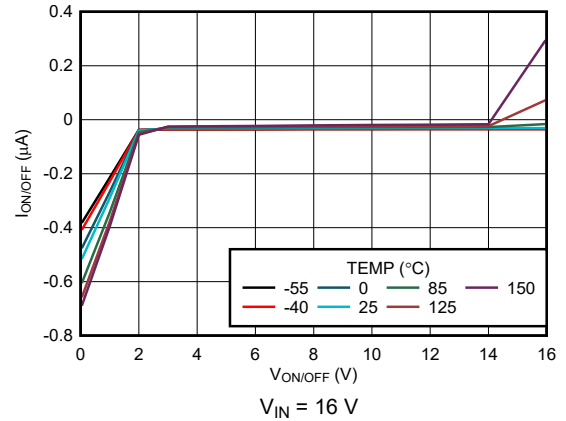


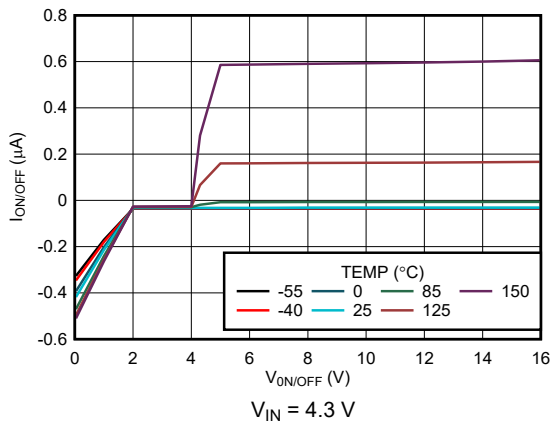
Figure 5-36. Output Impedance versus Frequency (Legacy chip)



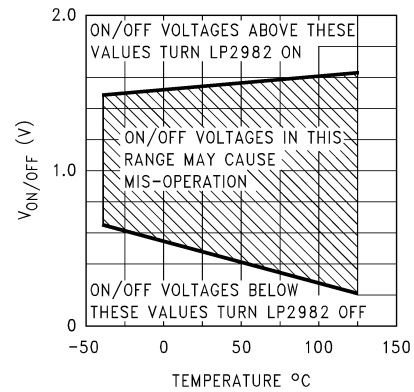
**Figure 5-37. ON/  $\overline{\text{OFF}}$  Pin Current versus  $V_{\text{ON/OFF}}$  (Legacy chip)**



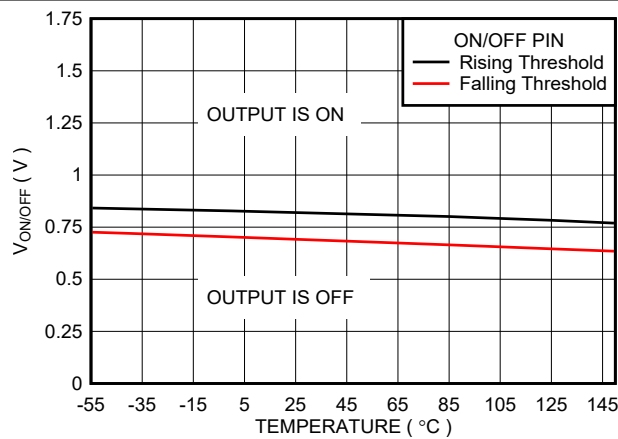
**Figure 5-38. ON/  $\overline{\text{OFF}}$  Pin Current versus  $V_{\text{ON/OFF}}$  (New Chip)**



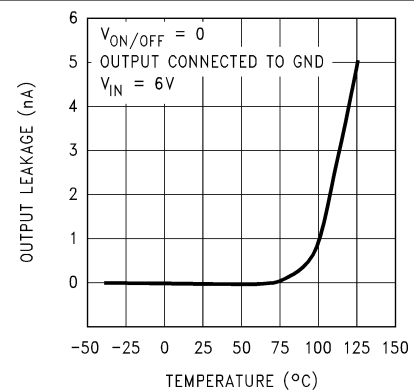
**Figure 5-39. ON/  $\overline{\text{OFF}}$  Pin Current versus  $V_{\text{ON/OFF}}$  (New Chip)**



**Figure 5-40. ON/  $\overline{\text{OFF}}$  Threshold versus Temperature (Legacy chip)**



**Figure 5-41. ON/  $\overline{\text{OFF}}$  Threshold versus Temperature (New chip)**



**Figure 5-42. Input-to-Output Leakage versus Temperature (Legacy chip)**

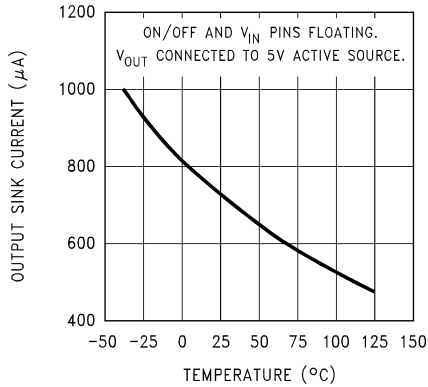


Figure 5-43. Output Reverse Leakage versus Temperature (Legacy chip)

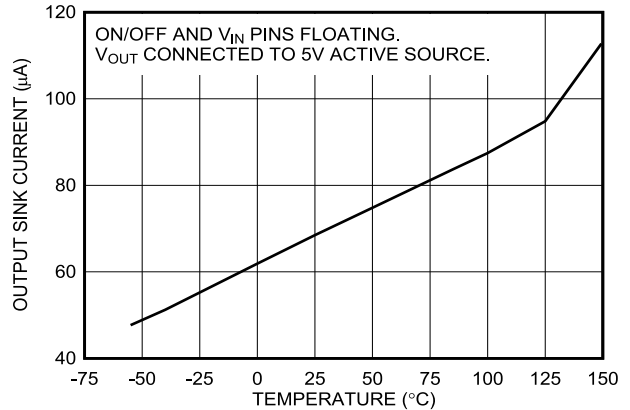


Figure 5-44. Output Reverse Leakage versus Temperature (New chip)

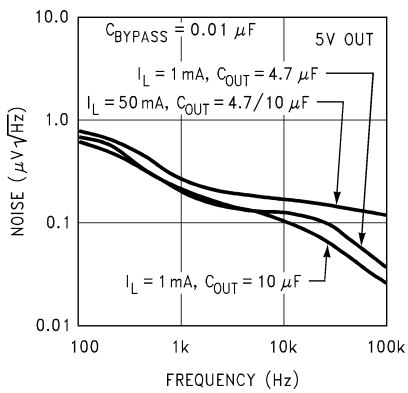


Figure 5-45. Output Noise Density (Legacy chip)

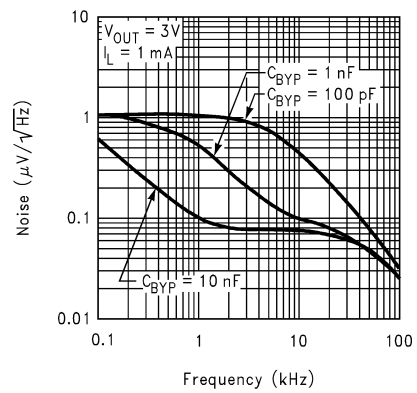


Figure 5-46. Output Noise Density (Legacy chip)

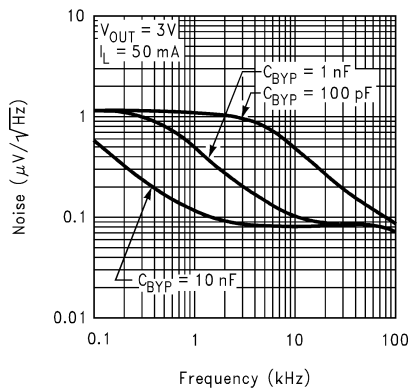


Figure 5-47. Output Noise Density (Legacy chip)

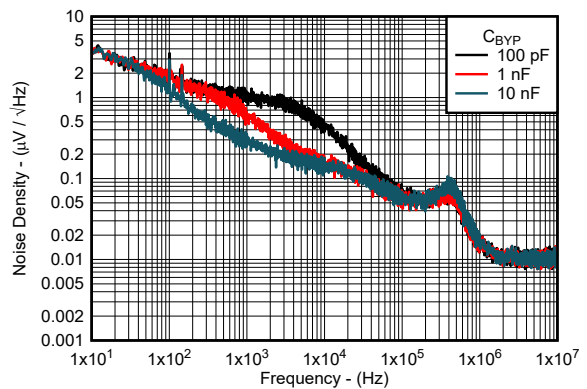
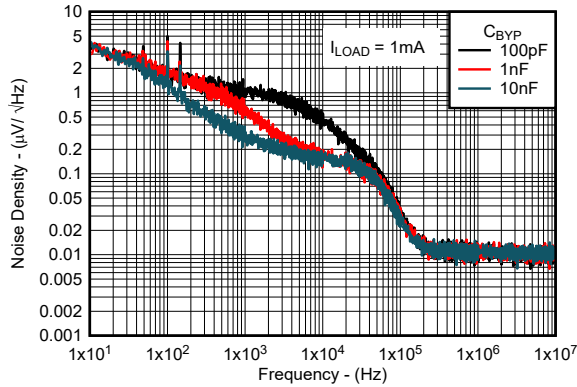
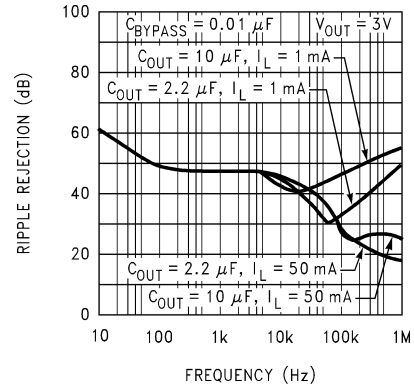


Figure 5-48. Output Noise Density versus Frequency (New Chip)

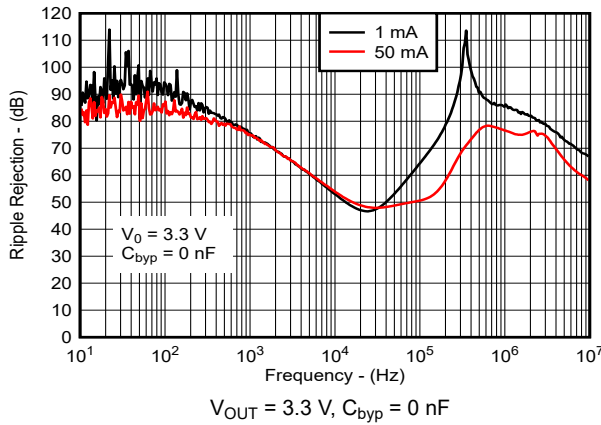


$V_{IN} = 4.3V$ ,  $V_{OUT} = 3.3V$ ,  $C_{OUT} = 2.2\mu F$  and  $I_{LOAD} = 1\text{ mA}$

**Figure 5-49. Output Noise Density versus Frequency for New Chip**

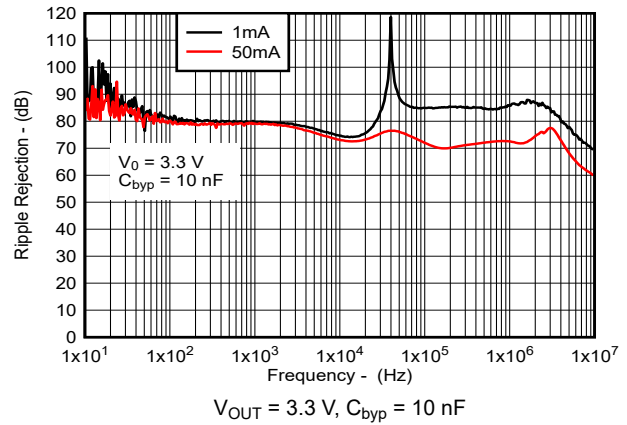


**Figure 5-50. Ripple Rejection (Legacy chip)**



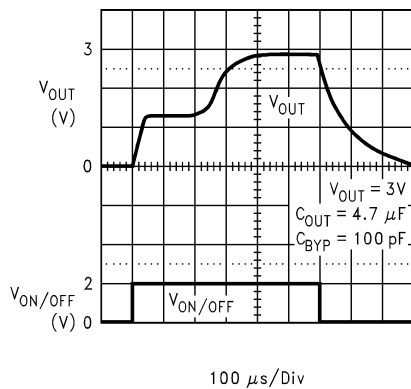
$V_{OUT} = 3.3\text{ V}$ ,  $C_{byp} = 0\text{ nF}$

**Figure 5-51. Ripple Rejection versus  $I_{OUT}$  (New Chip)**

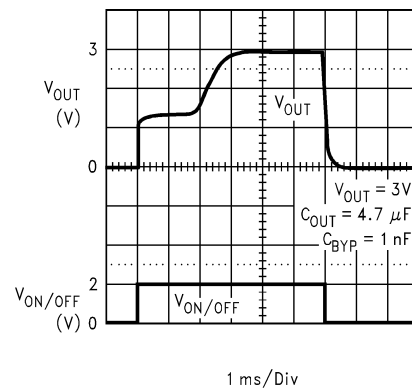


$V_{OUT} = 3.3\text{ V}$ ,  $C_{byp} = 10\text{ nF}$

**Figure 5-52. Ripple Rejection versus  $I_{OUT}$  (New Chip)**

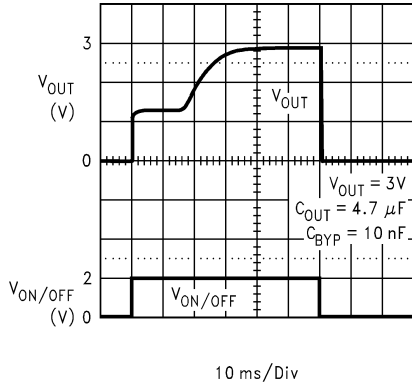


**Figure 5-53. Turnon Waveform (Legacy chip)**

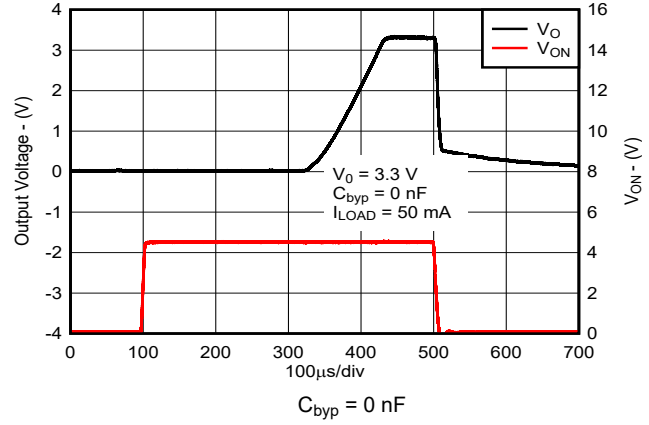


**Figure 5-54. Turnon Waveform (Legacy chip)**

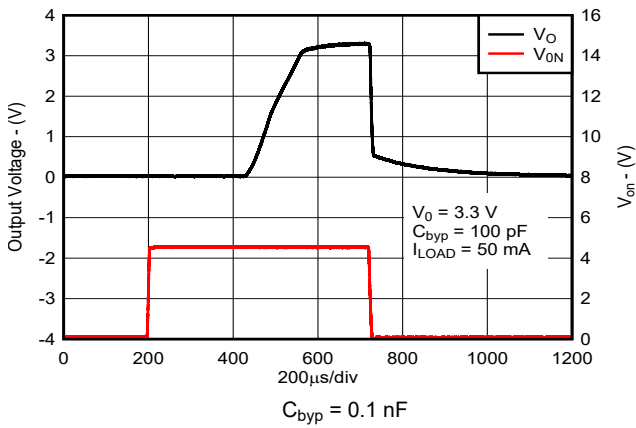




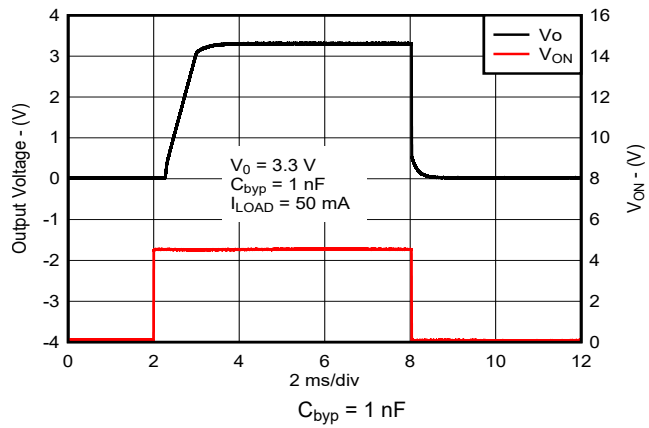
**Figure 5-55. Turnon Waveform (Legacy chip)**



**Figure 5-56. Turnon Waveform (New chip)**



**Figure 5-57. Turnon Waveform (New chip)**



**Figure 5-58. Turnon Waveform (New chip)**

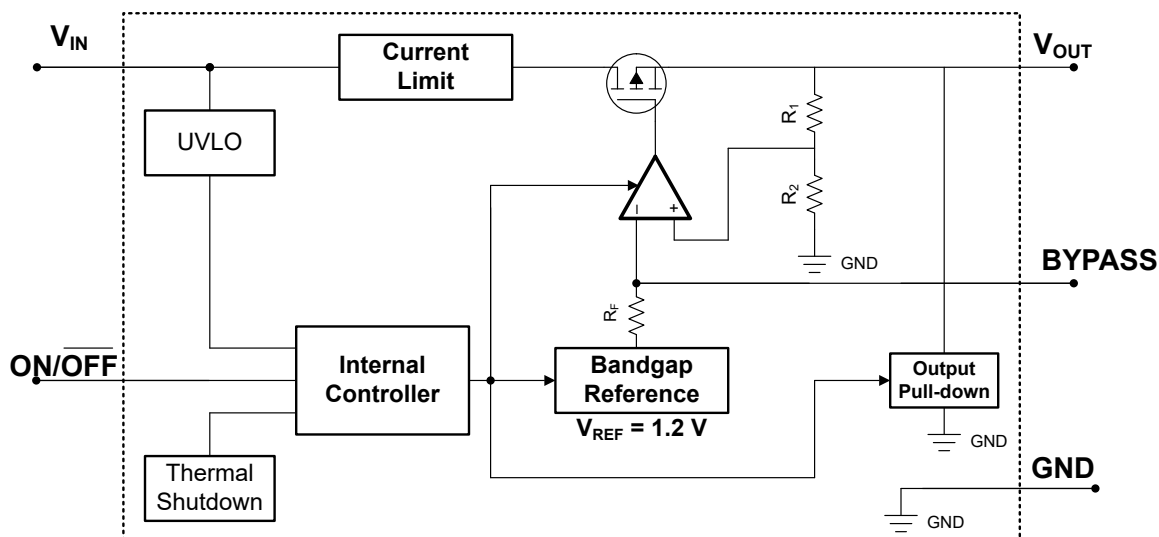
## 6 Detailed Description

### 6.1 Overview

The LP2982 is a fixed-output, low-noise, high PSRR, low-dropout regulator that offers exceptional, cost-effective performance for both portable and nonportable applications. The LP2982 has an output tolerance of 1% across line, load, and temperature variation (for the new chip) and is capable of delivering 50 mA of continuous load current.

This device features integrated overcurrent protection, thermal shutdown, output enable, and internal output pulldown and has a built-in soft-start mechanism for controlled inrush current. This device delivers excellent line and load transient performance. The operating ambient temperature range of the device is  $-40^{\circ}\text{C}$  to  $+125^{\circ}\text{C}$ .

### 6.2 Functional Block Diagram



### 6.3 Feature Description

#### 6.3.1 Output Enable

The  $\text{ON}/\overline{\text{OFF}}$  pin for the device is an active-high pin. The output voltage is enabled when the voltage of the  $\text{ON}/\overline{\text{OFF}}$  pin is greater than the high-level input voltage of the  $\text{ON}/\overline{\text{OFF}}$  pin and disabled with the  $\text{ON}/\overline{\text{OFF}}$  pin voltage is less than the low-level input voltage of the  $\text{ON}/\overline{\text{OFF}}$  pin. If independent control of the output voltage is not needed, connect the  $\text{ON}/\overline{\text{OFF}}$  pin to the input of the device.

The device has an internal pulldown circuit that activates when the device is disabled by pulling the  $\text{ON}/\overline{\text{OFF}}$  pin voltage lower than the low-level input voltage of the  $\text{ON}/\overline{\text{OFF}}$  pin, to actively discharge the output voltage.

#### 6.3.2 Dropout Voltage

Dropout voltage ( $V_{\text{DO}}$ ) is defined as the input voltage minus the output voltage ( $V_{\text{IN}} - V_{\text{OUT}}$ ) at the rated output current ( $I_{\text{RATED}}$ ), where the pass transistor is fully on.  $I_{\text{RATED}}$  is the maximum  $I_{\text{OUT}}$  listed in the [Section 5.3](#) table. The pass transistor is in the ohmic or triode region of operation, and acts as a switch. The dropout voltage indirectly specifies a minimum input voltage greater than the nominal programmed output voltage at which the output voltage is expected to stay in regulation. If the input voltage falls to less than the nominal output regulation, then the output voltage falls as well.

For a CMOS regulator, the dropout voltage is determined by the drain-source on-state resistance ( $R_{DS(ON)}$ ) of the pass transistor. Therefore, if the linear regulator operates at less than the rated current, the dropout voltage for that current scales accordingly. The following equation calculates the  $R_{DS(ON)}$  of the device.

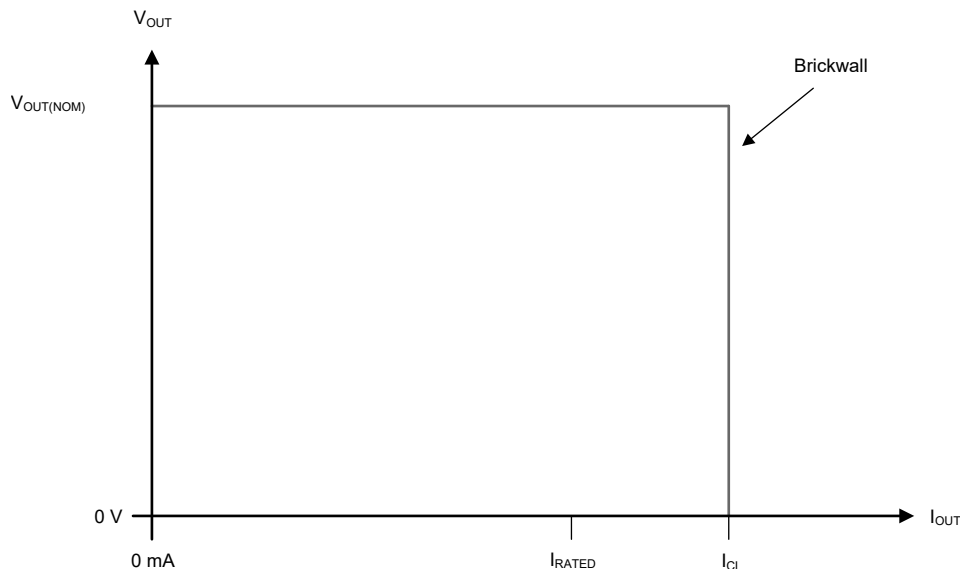
$$R_{DS(ON)} = \frac{V_{DO}}{I_{RATED}} \quad (1)$$

### 6.3.3 Current Limit

The device has an internal current limit circuit that protects the regulator during transient high-load current faults or shorting events. The current limit is a brick-wall scheme. In a high-load current fault, the brick-wall scheme limits the output current to the current limit ( $I_{CL}$ ).  $I_{CL}$  is listed in the [Section 5.5](#) table.

The output voltage is not regulated when the device is in current limit. When a current limit event occurs, the device begins to heat up because of the increase in power dissipation. When the device is in brick-wall current limit, the pass transistor dissipates power  $[(V_{IN} - V_{OUT}) \times I_{CL}]$ . If thermal shutdown is triggered, the device turns off. After the device cools down, the internal thermal shutdown circuit turns the device back on. If the output current fault condition continues, the device cycles between current limit and thermal shutdown. For more information on current limits, see the [Know Your Limits application note](#).

[Figure 6-1](#) shows a diagram of the current limit.



**Figure 6-1. Current Limit**

### 6.3.4 Undervoltage Lockout (UVLO)

The device has an independent undervoltage lockout (UVLO) circuit that monitors the input voltage, allowing a controlled and consistent turn on and off of the output voltage. To prevent the device from turning off if the input drops during turn on, the UVLO has hysteresis as specified in the [Section 5.5](#) table.

### 6.3.5 Output Pulldown

The new chip has an output pulldown circuit. The output pulldown activates in the following conditions:

- When the device is disabled ( $V_{ON/OFF} < V_{ON/OFF(LOW)}$ )
- If  $1.0\text{ V} < V_{IN} < V_{UVLO}$

Do not rely on the output pulldown circuit for discharging a large amount of output capacitance after the input supply has collapsed because reverse current can flow from the output to the input. This reverse current flow can cause damage to the device. See the [Section 7.1.4](#) section for more details.

### 6.3.6 Thermal Shutdown

The device contains a thermal shutdown protection circuit to disable the device when the junction temperature ( $T_J$ ) of the pass transistor rises to  $T_{SD(shutdown)}$  (typical). Thermal shutdown hysteresis enables the device to reset (turns on) when the temperature falls to  $T_{SD(reset)}$  (typical). Thermal shutdown circuit limits are defined in [Section 5.5](#) section.

The thermal time-constant of the semiconductor die is fairly short, thus the device can cycle on and off when thermal shutdown is reached until power dissipation is reduced. Power dissipation during start up can be high from large  $V_{IN} - V_{OUT}$  voltage drops across the device or from high inrush currents charging large output capacitors. Under some conditions, the thermal shutdown protection disables the device before start up completes.

For reliable operation, limit the junction temperature to the maximum listed in the [Section 5.3](#) table. Operation above this maximum temperature causes the device to exceed operational specifications. Although the internal protection circuitry of the device is designed to protect against thermal overall conditions, this circuitry is not intended to replace proper heat sinking. Continuously running the device into thermal shutdown or above the maximum recommended junction temperature reduces long-term reliability.

## 6.4 Device Functional Modes

### 6.4.1 Device Functional Mode Comparison

[Device Functional Mode Comparison](#) shows the conditions that lead to the different modes of operation. See the [Section 5.5](#) table for parameter values.

**Table 6-1. Device Functional Mode Comparison**

| OPERATING MODE                                       | PARAMETER   |                                |                          |                          |
|--|---|--------------------------------|--------------------------|--------------------------|
|  | $V_{IN}$  | $V_{ON/OFF}$                   | $I_{OUT}$                | $T_J$                    |
| Normal operation                                     | $V_{IN} > V_{OUT(nom)} + V_{DO}$ and $V_{IN} > V_{IN(min)}$ | $V_{ON/OFF} > V_{ON/OFF(HI)}$  | $I_{OUT} < I_{OUT(max)}$ | $T_J < T_{SD(shutdown)}$ |
| Dropout operation                                    | $V_{IN(min)} < V_{IN} < V_{OUT(nom)} + V_{DO}$              | $V_{ON/OFF} > V_{ON/OFF(HI)}$  | $I_{OUT} < I_{OUT(max)}$ | $T_J < T_{SD(shutdown)}$ |
| Disabled<br>(any true condition disables the device) | $V_{IN} < V_{UVLO}$   | $V_{ON/OFF} < V_{ON/OFF(LOW)}$ | Not applicable           | $T_J > T_{SD(shutdown)}$ |

### 6.4.2 Normal Operation

The device regulates to the nominal output voltage when the following conditions are met:

- The input voltage is greater than the nominal output voltage plus the dropout voltage ( $V_{OUT(nom)} + V_{DO}$ )
- The output current is less than the current limit ( $I_{OUT} < I_{CL}$ )
- The device junction temperature is less than the thermal shutdown temperature ( $T_J < T_{SD}$ )
- The ON/OFF voltage has previously exceeded the ON/OFF rising threshold voltage and has not yet decreased to less than the enable falling threshold

### 6.4.3 Dropout Operation

If the input voltage is lower than the nominal output voltage plus the specified dropout voltage, but all other conditions are met for normal operation, the device operates in dropout mode. In this mode, the output voltage tracks the input voltage. During this mode, the transient performance of the device becomes significantly degraded because the pass transistor is in the ohmic or triode region, and acts as a switch. Line or load transients in dropout can result in large output-voltage deviations.

When the device is in a steady dropout state (defined as when the device is in dropout,  $V_{IN} < V_{OUT(NOM)} + V_{DO}$ , directly after being in a normal regulation state, but *not* during start up), the pass transistor is driven into the ohmic or triode region. When the input voltage returns to a value greater than or equal to the nominal output voltage plus the dropout voltage ( $V_{OUT(NOM)} + V_{DO}$ ), the output voltage can overshoot for a short period of time while the device pulls the pass transistor back into the linear region.

### 6.4.4 Disabled

The output of the device can be shutdown by forcing the voltage of the ON/ $\overline{\text{OFF}}$  pin to less than the maximum ON/ $\overline{\text{OFF}}$  pin low-level input voltage (see the [Section 5.5](#) table). When disabled, the pass transistor is turned off, internal circuits are shutdown, and the output voltage is actively discharged to ground by an internal discharge circuit from the output to ground.

## 7 Application and Implementation

---

### Note

Information in the following applications sections is not part of the TI component specification, and TI does not warrant its accuracy or completeness. TI's customers are responsible for determining suitability of components for their purposes, as well as validating and testing their design implementation to confirm system functionality.

---

### 7.1 Application Information

The LP2982 is a linear voltage regulator operating from 2.5 V to 16 V (for new chip) on the input and regulates voltages between 1.2 V to 5 V with  $\pm 1\%$  accuracy (across line, load and temperature) and 50-mA maximum output current.

Successfully implementing an LDO in an application depends on the application requirements. If the requirements are simply input voltage and output voltage, compliance specifications (such as internal power dissipation or stability) must be verified for a solid design. If timing, start-up, noise, power supply rejection ratio (PSRR), or any other transient specification is required, then the design becomes more challenging.

#### 7.1.1 Recommended Capacitor Types

##### 7.1.1.1 Recommended Capacitors for the Legacy Chip

**Tantalum Capacitors:** For the legacy chip LP2981-N, tantalum capacitors are the best choice for use at the output of the LDO. Most good quality tantalums can be used with the LP2981-N, but check the manufacturer's data sheet to be sure the ESR is in range. At lower temperatures, as ESR increases, a capacitor with ESR, near the upper limit for stability at room temperature can cause instability. For very low temperature applications, output tantalum capacitors can be used in parallel configuration to prevent the ESR from going up too high.

**Ceramic Capacitors:** For the legacy chip LP2981-N, ceramic capacitors are not recommended for use at the output of the LDO. This is because the ESR of a ceramic can be low enough to go below the minimum stable value for the LP2981-N. A 2.2- $\mu$ F ceramic was measured and found to have an ESR of about 15 m $\Omega$ , which is low enough to cause oscillations. If a ceramic capacitor is used on the output, a 1- $\Omega$  resistor is required be placed in series with the capacitor.

**Aluminum Capacitors:** For the legacy chip LP2981-N, aluminum electrolytics are not typically used with the LDO, because of the large physical size. These aluminum capacitors must meet the same ESR requirements over the operating temperature range, more difficult because of their steep increase at cold temperature. An aluminum electrolytic can exhibit an ESR increase of as much as 50x when going from 20°C to -40°C. Also, some aluminum electrolytics are not operational below -25°C because the electrolyte can freeze.

##### 7.1.1.2 Recommended Capacitors for the New Chip

The new chip is designed to be stable using low equivalent series resistance (ESR) ceramic capacitors at the input and output. Multilayer ceramic capacitors have become the industry standard for these types of applications and are recommended, but must be used with good judgment. Ceramic capacitors that employ X7R-, X5R-, and C0G-rated dielectric materials provide relatively good capacitive stability across temperature, whereas using Y5V-rated capacitors is discouraged because of large variations in capacitance.

Regardless of the ceramic capacitor type selected, the effective capacitance varies with operating voltage and temperature. Generally, expect the effective capacitance to decrease by as much as 50%. The input and output capacitors listed in the [Section 5.3](#) table account for an effective capacitance of approximately 50% of the nominal value.

#### 7.1.2 Input and Output Capacitor Requirements

Although an input capacitor is not required for stability, good analog design practice is to connect a capacitor from IN to GND. This capacitor counteracts reactive input sources and improves transient response, input ripple, and PSRR. Use an input capacitor if the source impedance is more than 0.5  $\Omega$ . A higher value capacitor can be

necessary if large, fast rise-time load or line transients are anticipated or if the device is located several inches from the input power source.

Dynamic performance of the device is improved with the use of an output capacitor. Use an output capacitor within the range specified in the [Section 5.3](#) table for stability.

### 7.1.3 Noise Bypass Capacitor (C<sub>BYPASS</sub>)

The LP2982 allows for low-noise performance with the use of a bypass capacitor that is connected to the internal band-gap reference with the BYPASS pin. This high-impedance band-gap circuitry is biased in the microampere range and, thus, cannot be loaded significantly, otherwise, the output (and, correspondingly, the output of the regulator) changes. Thus, for best output accuracy, dc leakage current through C<sub>BYPASS</sub> must be minimized as much as possible and must never exceed 100 nA. The C<sub>BYPASS</sub> capacitor also impacts the start-up behavior of the regulator. Inrush current and start-up time increase with larger bypass capacitor values.

Use a 10-nF capacitor for C<sub>BYPASS</sub>. Ceramic and film capacitors are good choices for this purpose.

### 7.1.4 Reverse Current

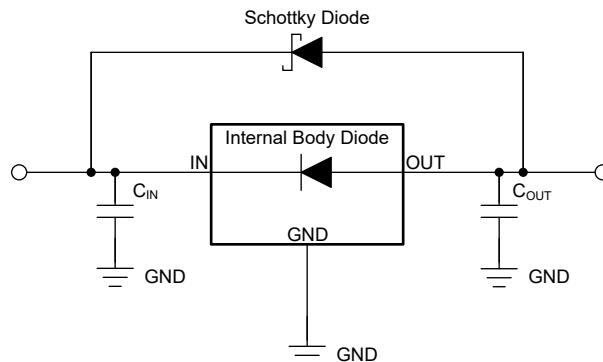
Excessive reverse current can damage this device. Reverse current flows through the intrinsic body diode of the pass transistor instead of the normal conducting channel. At high magnitudes, this current flow degrades the long-term reliability of the device.

Conditions where reverse current can occur are outlined in this section, all of which can exceed the absolute maximum rating of  $V_{OUT} \leq V_{IN} + 0.3 \text{ V}$ .

- If the device has a large C<sub>OUT</sub> and the input supply collapses with little or no load current
- The output is biased when the input supply is not established
- The output is biased above the input supply

If reverse current flow is expected in the application, use external protection to protect the device. Reverse current is not limited in the device, so external limiting is required if extended reverse voltage operation is anticipated.

[Figure 7-1](#) shows one approach for protecting the device.



**Figure 7-1. Example Circuit for Reverse Current Protection Using a Schottky Diode**

### 7.1.5 Power Dissipation (P<sub>D</sub>)

Circuit reliability requires consideration of the device power dissipation, location of the circuit on the printed circuit board (PCB), and correct sizing of the thermal plane. The PCB area around the regulator must have few or no other heat-generating devices that cause added thermal stress.

To first-order approximation, power dissipation in the regulator depends on the input-to-output voltage difference and load conditions. The following equation calculates power dissipation (P<sub>D</sub>).

$$P_D = (V_{IN} - V_{OUT}) \times I_{OUT} \quad (2)$$

### Note

Power dissipation can be minimized, and therefore greater efficiency can be achieved, by correct selection of the system voltage rails. For the lowest power dissipation use the minimum input voltage required for correct output regulation.

For devices with a thermal pad, the primary heat conduction path for the device package is through the thermal pad to the PCB. Solder the thermal pad to a copper pad area under the device. This pad area must contain an array of plated vias that conduct heat to additional copper planes for increased heat dissipation.

The maximum power dissipation determines the maximum allowable ambient temperature ( $T_A$ ) for the device. According to the following equation, power dissipation and junction temperature are most often related by the junction-to-ambient thermal resistance ( $R_{\theta JA}$ ) of the combined PCB and device package and the temperature of the ambient air ( $T_A$ ).

$$T_J = T_A + (R_{\theta JA} \times P_D) \quad (3)$$

Thermal resistance ( $R_{\theta JA}$ ) is highly dependent on the heat-spreading capability built into the particular PCB design, and therefore varies according to the total copper area, copper weight, and location of the planes. The junction-to-ambient thermal resistance listed in the [Section 5.4](#) table is determined by the JEDEC standard PCB and copper-spreading area, and is used as a relative measure of package thermal performance.

#### 7.1.6 Estimating Junction Temperature

The JEDEC standard now recommends the use of psi ( $\Psi$ ) thermal metrics to estimate the junction temperatures of the linear regulator when in-circuit on a typical PCB board application. These metrics are not thermal resistance parameters and instead offer a practical and relative way to estimate junction temperature. These psi metrics are determined to be significantly independent of the copper area available for heat-spreading. The [Section 5.4](#) table lists the primary thermal metrics, which are the junction-to-top characterization parameter ( $\psi_{JT}$ ) and junction-to-board characterization parameter ( $\psi_{JB}$ ). These parameters provide two methods for calculating the junction temperature ( $T_J$ ), as described in the following equations. Use the junction-to-top characterization parameter ( $\psi_{JT}$ ) with the temperature at the center-top of device package ( $T_T$ ) to calculate the junction temperature. Use the junction-to-board characterization parameter ( $\psi_{JB}$ ) with the PCB surface temperature 1 mm from the device package ( $T_B$ ) to calculate the junction temperature.

$$T_J = T_T + \psi_{JT} \times P_D \quad (4)$$

where:

- $P_D$  is the dissipated power
- $T_T$  is the temperature at the center-top of the device package

$$T_J = T_B + \psi_{JB} \times P_D \quad (5)$$

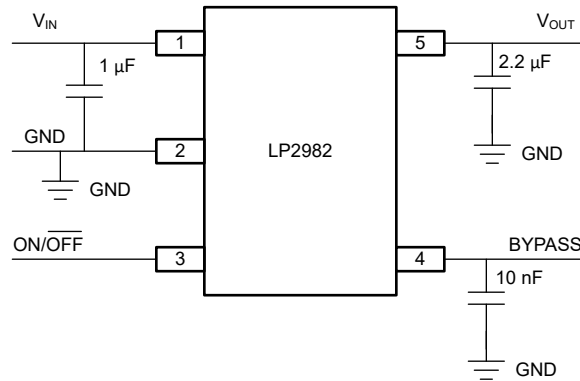
where:

- $T_B$  is the PCB surface temperature measured 1 mm from the device package and centered on the package edge

For detailed information on the thermal metrics and how to use them, see the [Semiconductor and IC Package Thermal Metrics application note](#).



## 7.2 Typical Application



ON/  $\overline{\text{OFF}}$  input must be actively terminated. Tie to  $V_{\text{IN}}$  if this function is not to be used. Minimum output capacitance is shown to insure stability over full load current range. More capacitance provides better dynamic performance and additional stability margin (see [Section 7.1.1](#)).

**Figure 7-2. LP2982 Typical Application**

### 7.2.1 Design Requirements

| PARAMETER           | DESIGN REQUIREMENT |
|---------------------|--------------------|
| Input voltage       | 12 V $\pm$ 10%     |
| Output voltage      | 3.3 V $\pm$ 1.5%   |
| Output current      | 50 mA              |
| Ambient temperature | 85°C               |

### 7.2.2 Detailed Design Procedure

#### 7.2.2.1 ON/ $\overline{\text{OFF}}$ Input Operation

The LP2982 is shut off by pulling the ON/  $\overline{\text{OFF}}$  input low, and turned on by driving the input high. If this feature is not to be used, the ON/OFF input required to be tied to  $V_{\text{IN}}$  to keep the regulator on at all times (the ON/  $\overline{\text{OFF}}$  input must **not** be left floating).

For proper operation of the LDO, the signal source used to drive the ON/  $\overline{\text{OFF}}$  input must be able to swing above and below the specified turnon/turnoff voltage thresholds which specify an ON or  $\overline{\text{OFF}}$  state.

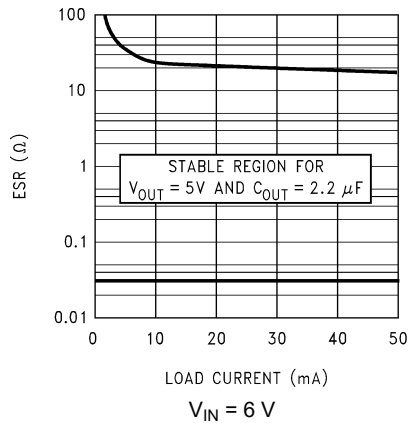
The ON/  $\overline{\text{OFF}}$  signal can come from either a totem-pole output, or an open-collector output with pullup resistor to the LP2982 input voltage or another logic supply. The high-level voltage can exceed the LP2982 input voltage, but must remain within the absolute maximum ratings for the ON/  $\overline{\text{OFF}}$  pin.

It is also important that the turnon/turnoff voltage signals applied to the ON/  $\overline{\text{OFF}}$  input have a slew rate which is greater than 40 mV/ $\mu$ s.

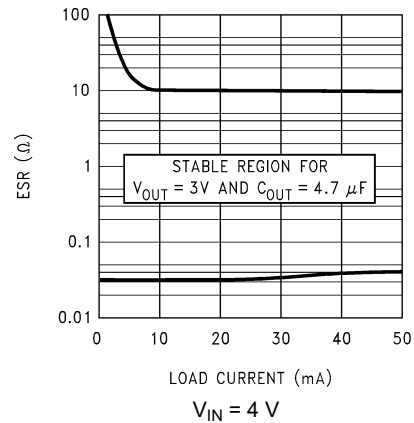
#### Note

**IMPORTANT:** For the legacy chip, the regulator shutdown function does not operate correctly if a slow-moving signal is applied to the ON/  $\overline{\text{OFF}}$  input.

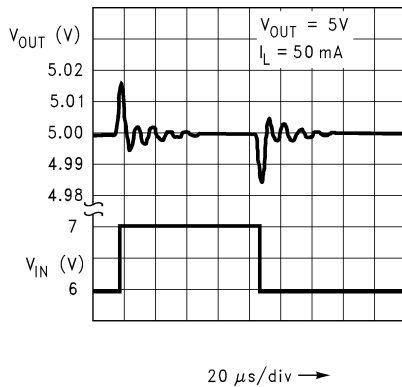
### 7.2.3 Application Curves



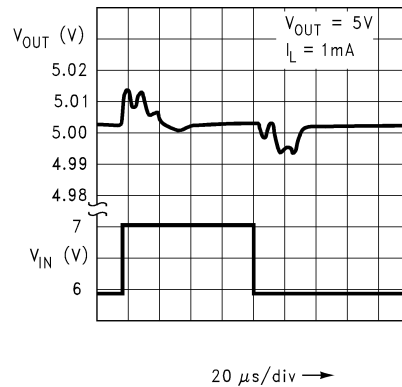
**Figure 7-3. 5-V, 2.2-µF ESR Curves (Legacy chip)**



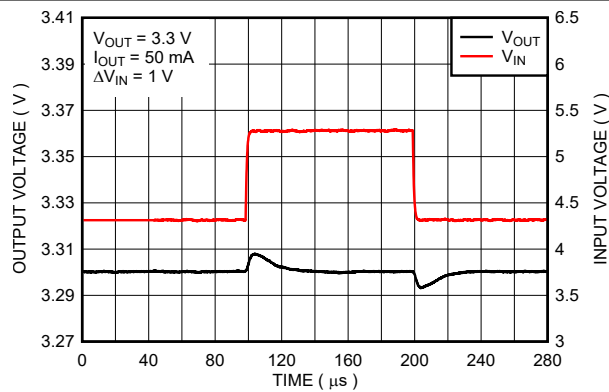
**Figure 7-4. 3-V, 4.7-µF ESR Curves (Legacy chip)**



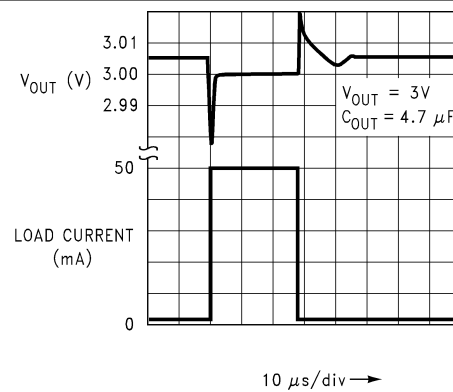
**Figure 7-5. Line Transient Response (Legacy chip)**



**Figure 7-6. Line Transient Response (Legacy chip)**



**Figure 7-7. Line Transient Response (New Chip)**



**Figure 7-8. Load Transient Response (Legacy chip)**

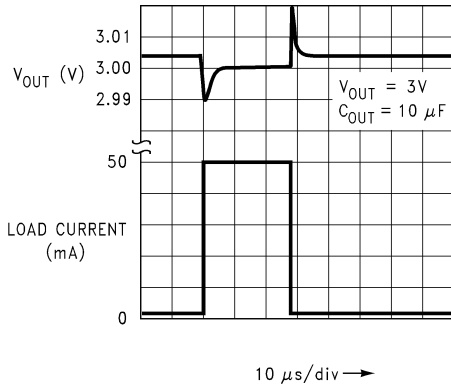


Figure 7-9. Load Transient Response (Legacy chip)

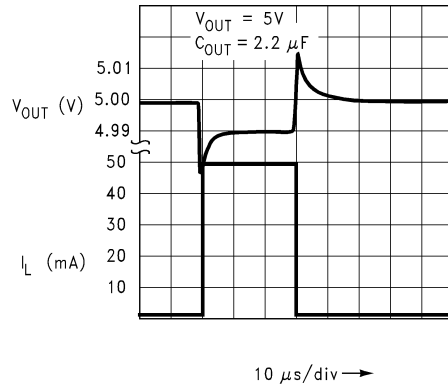


Figure 7-10. Load Transient Response (Legacy chip)

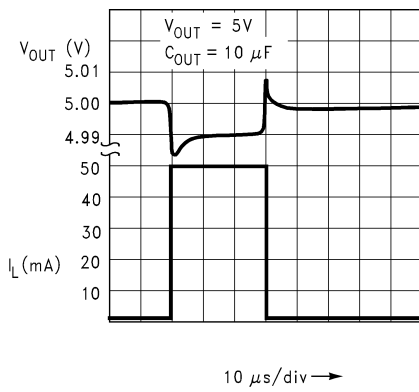


Figure 7-11. Load Transient Response (Legacy chip)

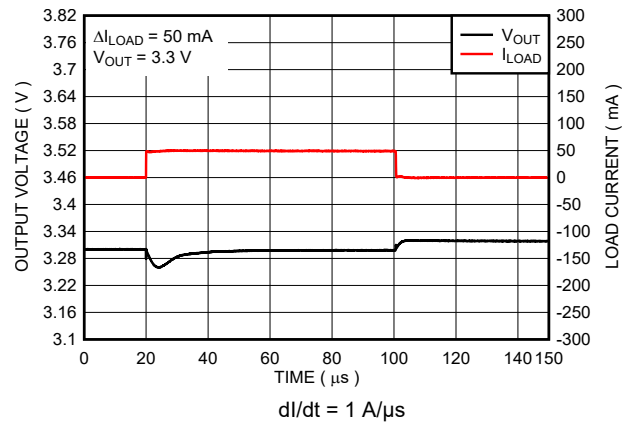


Figure 7-12. Load Transient Response (New Chip)

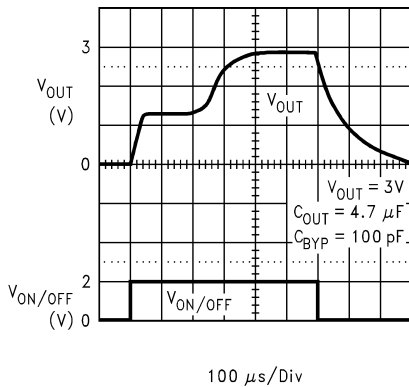


Figure 7-13. Turnon Waveform (Legacy chip)

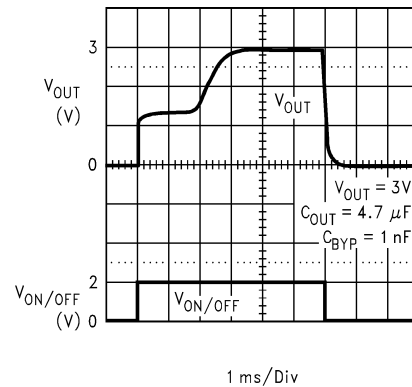
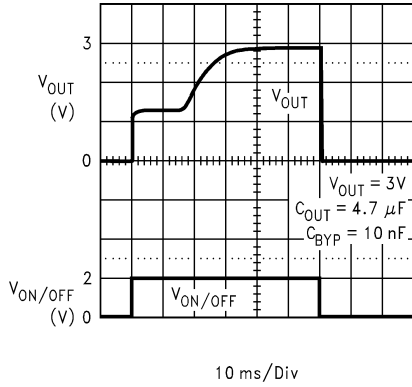
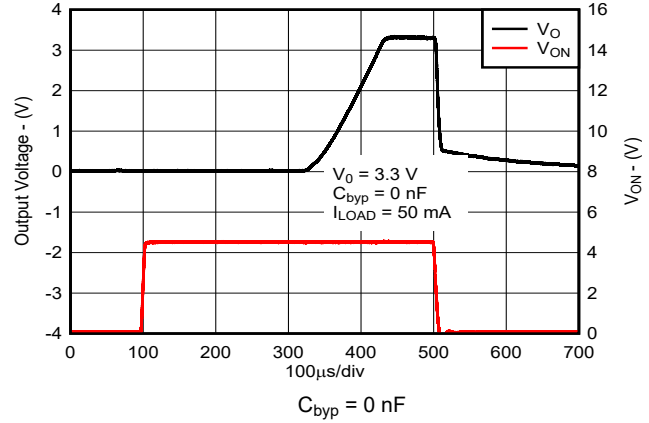


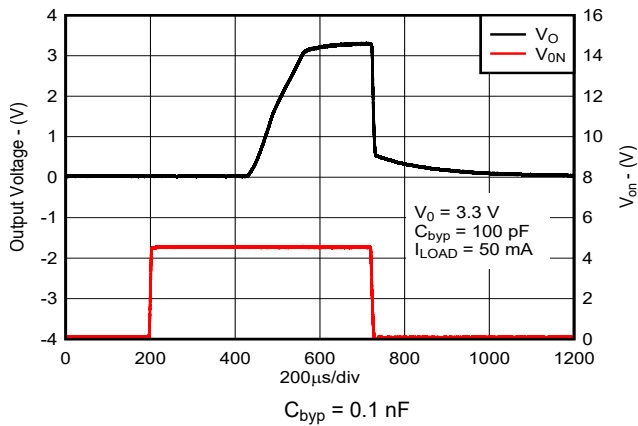
Figure 7-14. Turnon Waveform (Legacy chip)



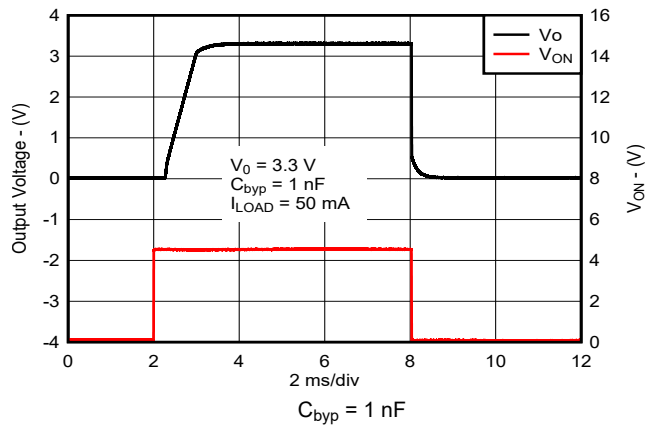
**Figure 7-15. Turnon Waveform (Legacy chip)**



**Figure 7-16. Turnon Waveform (New chip)**



**Figure 7-17. Turnon Waveform (New chip)**



**Figure 7-18. Turnon Waveform (New chip)**

## 8 Power Supply Recommendations

The LP2982 is designed to operate from an input voltage supply range between  $V_{OUT(NOM)} + 1\text{ V}$  and 16 V. The input voltage range provides adequate headroom for the device to have a regulated output. This input supply must be well regulated. If the input supply is noisy, additional input capacitors with low ESR can help improve the output noise performance.

## 9 Layout

### 9.1 Layout Guidelines

For best overall performance, place all circuit components on the same side of the circuit board and as near as practical to the respective LDO pin connections. Place ground return connections to the input and output capacitors, and to the LDO ground pin as close to each other as possible, connected by a wide, component-side, copper surface. The use of vias and long traces to create LDO circuit connections is strongly discouraged and negatively affects system performance. This grounding and layout scheme minimizes inductive parasitics, and thereby reduces load-current transients, minimizes noise, and increases circuit stability. A ground reference plane is also recommended and is either embedded in the PCB itself or located on the bottom side of the PCB opposite the components. This reference plane serves for better accuracy of the output voltage, shield noise, and behaves similar to a thermal plane to spread (or sink) heat from the LDO device. In most applications, this ground plane is necessary to meet thermal requirements.

### 9.2 Layout Example

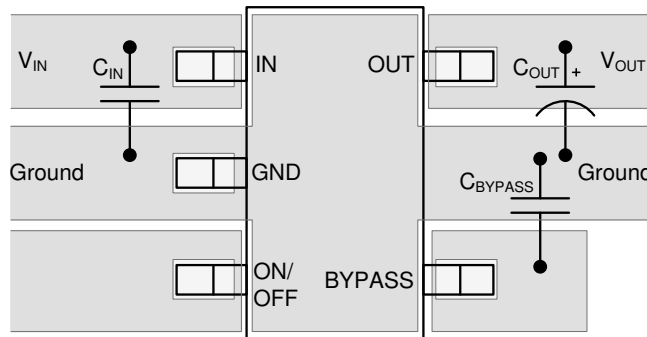


Figure 9-1. LP2982 Layout Example

## 10 Device and Documentation Support

### 10.1 Device Nomenclature

**Table 10-1. Available Options**

| PRODUCT                              | V <sub>OUT</sub>  |
|--------------------------------------|---|
| LP2982cxxxzX-y.y/NOPB<br>Legacy chip | c is the accuracy specification. xxx is the package designator. z is the package quantity. X is for a large-quantity reel and non-X is for a small-quantity reel. y.y is the nominal output voltage (for example, 3.3 = 3.3 V; 5.0 = 5.0 V).  |
| LP2982AxxxzX-y.y/M3<br>New chip      | A is for higher accuracy and non-A is for standard grade. xxx is the package designator. z is the package quantity. X is for a large-quantity reel and non-X is for a small-quantity reel. y.y is the nominal output voltage (for example, 3.3 = 3.3 V; 5.0 = 5.0 V). M3 is a suffix designator for newer chip redesigns, fabricated on the latest TI process technology. |

### 10.2 Third-Party Products Disclaimer

TI'S PUBLICATION OF INFORMATION REGARDING THIRD-PARTY PRODUCTS OR SERVICES DOES NOT CONSTITUTE AN ENDORSEMENT REGARDING THE SUITABILITY OF SUCH PRODUCTS OR SERVICES OR A WARRANTY, REPRESENTATION OR ENDORSEMENT OF SUCH PRODUCTS OR SERVICES, EITHER ALONE OR IN COMBINATION WITH ANY TI PRODUCT OR SERVICE.

### 10.3 Documentation Support

#### 10.3.1 Related Documentation

For additional information, see the following:

- TI Application Report *Semiconductor and IC Package Thermal Metrics* ([SPRA953](#))
- TI Application Report *Using New Thermal Metrics* ([SBVA025](#))
- TI Application Report *Thermal Characteristics of Linear and Logic Packages Using JEDEC PCB Designs* ([SZZA017](#))

### 10.4 Receiving Notification of Documentation Updates

To receive notification of documentation updates, navigate to the device product folder on ti.com. In the upper right corner, click on *Alert me* to register and receive a weekly digest of any product information that has changed. For change details, review the revision history included in any revised document.

### 10.5 Support Resources

[TI E2E™ support forums](#) are an engineer's go-to source for fast, verified answers and design help — straight from the experts. Search existing answers or ask your own question to get the quick design help you need.

Linked content is provided "AS IS" by the respective contributors. They do not constitute TI specifications and do not necessarily reflect TI's views; see TI's [Terms of Use](#).

### 10.6 Trademarks

TI E2E™ is a trademark of Texas Instruments.

All trademarks are the property of their respective owners.

### 10.7 Electrostatic Discharge Caution



This integrated circuit can be damaged by ESD. Texas Instruments recommends that all integrated circuits be handled with appropriate precautions. Failure to observe proper handling and installation procedures can cause damage.

ESD damage can range from subtle performance degradation to complete device failure. Precision integrated circuits may be more susceptible to damage because very small parametric changes could cause the device not to meet its published specifications.

### 10.8 Glossary

[TI Glossary](#) This glossary lists and explains terms, acronyms, and definitions.

## 11 Revision History

NOTE: Page numbers for previous revisions may differ from page numbers in the current version.

| <b>Changes from , to , (from Revision K (June 2016) to Revision L (Dec 2023))</b>  | <b>Page</b> |
|--|-------------|
| • Updated the numbering format for tables, figures, and cross-references throughout the document.....  | 1           |
| • Changed entire document to align with current family format.....   | 1           |
| • Added M3 devices to document.....  | 1           |
| • Deleted TM symbol from VIP - no longer trademarked; changed word in title from "Regulator" to "LDO" .....  | 1           |
| • Added <i>Pin Configuration and Functions</i> section, <i>ESD Ratings</i> table, <i>Feature Description</i> section, <i>Device Functional Modes</i> , <i>Application and Implementation</i> section, <i>Power Supply Recommendations</i> section, <i>Layout</i> section, <i>Device and Documentation Support</i> section, and <i>Mechanical, Packaging, and Orderable Information</i> section ..... | 1           |
| • Changed update typical application drawing and change pin names from Vin, Vout to IN and OUT; remove last paragraph of <i>Description</i> beginning "Four output voltage versions...".....   | 1           |
| • Added <i>Output Pulldown</i> section.....  | 20          |
| • Changed layout of National Semiconductor Data Sheet to TI format.....  | 25          |
| • Added <i>Device Nomenclature</i> section.....  | 30          |

| <b>Changes from Revision J (April 2013) to Revision K (June 2016)</b>  | <b>Page</b> |
|--|-------------|
| • Deleted TM symbol from VIP - no longer trademarked; changed word in title from "Regulator" to "LDO" .....  | 1           |
| • Added <i>Pin Configuration and Functions</i> section, <i>ESD Ratings</i> table, <i>Feature Description</i> section, <i>Device Functional Modes</i> , <i>Application and Implementation</i> section, <i>Power Supply Recommendations</i> section, <i>Layout</i> section, <i>Device and Documentation Support</i> section, and <i>Mechanical, Packaging, and Orderable Information</i> section ..... | 1           |
| • Changed update typical application drawing and change pin names from Vin, Vout to IN and OUT; remove last paragraph of <i>Description</i> beginning "Four output voltage versions...".....   | 1           |

| <b>Changes from Revision I (April 2013) to Revision J (April 2013)</b>  | <b>Page</b> |
|---|-------------|
| • Changed layout of National Semiconductor Data Sheet to TI format..... | 25          |

## 12 Mechanical, Packaging, and Orderable Information

The following pages include mechanical, packaging, and orderable information. This information is the most current data available for the designated devices. This data is subject to change without notice and revision of this document. For browser-based versions of this data sheet, refer to the left-hand navigation.

**PACKAGING INFORMATION**

| Orderable Device     | Status<br>(1) | Package Type | Package Drawing | Pins | Package Qty | Eco Plan<br>(2) | Lead finish/<br>Ball material<br>(6) | MSL Peak Temp<br>(3) | Op Temp (°C) | Device Marking<br>(4/5) | Samples                 |
|----------------------|---------------|--------------|-----------------|------|-------------|-----------------|--------------------------------------|----------------------|--------------|-------------------------|-------------------------|
| LP2982AIM5-3.0/NOPB  | ACTIVE        | SOT-23       | DBV             | 5    | 1000        | RoHS & Green    | SN                                   | Level-1-260C-UNLIM   | -40 to 125   | L20A                    | <a href="#">Samples</a> |
| LP2982AIM5-3.3/NOPB  | ACTIVE        | SOT-23       | DBV             | 5    | 3000        | RoHS & Green    | SN                                   | Level-1-260C-UNLIM   | -40 to 125   | L19A                    | <a href="#">Samples</a> |
| LP2982AIM5-5.0/NOPB  | ACTIVE        | SOT-23       | DBV             | 5    | 3000        | RoHS & Green    | SN                                   | Level-1-260C-UNLIM   | -40 to 125   | L18A                    | <a href="#">Samples</a> |
| LP2982AIM5X-3.0/NOPB | ACTIVE        | SOT-23       | DBV             | 5    | 3000        | RoHS & Green    | SN                                   | Level-1-260C-UNLIM   | -40 to 125   | L20A                    | <a href="#">Samples</a> |
| LP2982AIM5X-3.3/NOPB | ACTIVE        | SOT-23       | DBV             | 5    | 3000        | RoHS & Green    | SN                                   | Level-1-260C-UNLIM   | -40 to 125   | L19A                    | <a href="#">Samples</a> |
| LP2982AIM5X-5.0/NOPB | ACTIVE        | SOT-23       | DBV             | 5    | 3000        | RoHS & Green    | SN                                   | Level-1-260C-UNLIM   | -40 to 125   | L18A                    | <a href="#">Samples</a> |
| LP2982IM5-3.0/NOPB   | ACTIVE        | SOT-23       | DBV             | 5    | 1000        | RoHS & Green    | SN                                   | Level-1-260C-UNLIM   | -40 to 125   | L20B                    | <a href="#">Samples</a> |
| LP2982IM5-3.3/NOPB   | ACTIVE        | SOT-23       | DBV             | 5    | 3000        | RoHS & Green    | SN                                   | Level-1-260C-UNLIM   | -40 to 125   | L19B                    | <a href="#">Samples</a> |
| LP2982IM5-5.0/NOPB   | ACTIVE        | SOT-23       | DBV             | 5    | 3000        | RoHS & Green    | SN                                   | Level-1-260C-UNLIM   | -40 to 125   | L18B                    | <a href="#">Samples</a> |
| LP2982IM5X-3.0/NOPB  | ACTIVE        | SOT-23       | DBV             | 5    | 3000        | RoHS & Green    | SN                                   | Level-1-260C-UNLIM   | -40 to 125   | L20B                    | <a href="#">Samples</a> |
| LP2982IM5X-3.3/NOPB  | ACTIVE        | SOT-23       | DBV             | 5    | 3000        | RoHS & Green    | SN                                   | Level-1-260C-UNLIM   | -40 to 125   | L19B                    | <a href="#">Samples</a> |
| LP2982IM5X-5.0/NOPB  | ACTIVE        | SOT-23       | DBV             | 5    | 3000        | RoHS & Green    | SN                                   | Level-1-260C-UNLIM   | -40 to 125   | L18B                    | <a href="#">Samples</a> |

(1) The marketing status values are defined as follows:

**ACTIVE:** Product device recommended for new designs.

**LIFEBUY:** TI has announced that the device will be discontinued, and a lifetime-buy period is in effect.

**NRND:** Not recommended for new designs. Device is in production to support existing customers, but TI does not recommend using this part in a new design.

**PREVIEW:** Device has been announced but is not in production. Samples may or may not be available.

**OBSOLETE:** TI has discontinued the production of the device.

(2) **RoHS:** TI defines "RoHS" to mean semiconductor products that are compliant with the current EU RoHS requirements for all 10 RoHS substances, including the requirement that RoHS substance do not exceed 0.1% by weight in homogeneous materials. Where designed to be soldered at high temperatures, "RoHS" products are suitable for use in specified lead-free processes. TI may reference these types of products as "Pb-Free".

**RoHS Exempt:** TI defines "RoHS Exempt" to mean products that contain lead but are compliant with EU RoHS pursuant to a specific EU RoHS exemption.

**Green:** TI defines "Green" to mean the content of Chlorine (Cl) and Bromine (Br) based flame retardants meet JS709B low halogen requirements of <=1000ppm threshold. Antimony trioxide based flame retardants must also meet the <=1000ppm threshold requirement.



- (3) MSL, Peak Temp. - The Moisture Sensitivity Level rating according to the JEDEC industry standard classifications, and peak solder temperature.
- (4) There may be additional marking, which relates to the logo, the lot trace code information, or the environmental category on the device.
- (5) Multiple Device Markings will be inside parentheses. Only one Device Marking contained in parentheses and separated by a "~" will appear on a device. If a line is indented then it is a continuation of the previous line and the two combined represent the entire Device Marking for that device.
- (6) Lead finish/Ball material - Orderable Devices may have multiple material finish options. Finish options are separated by a vertical ruled line. Lead finish/Ball material values may wrap to two lines if the finish value exceeds the maximum column width.

**Important Information and Disclaimer:**The information provided on this page represents TI's knowledge and belief as of the date that it is provided. TI bases its knowledge and belief on information provided by third parties, and makes no representation or warranty as to the accuracy of such information. Efforts are underway to better integrate information from third parties. TI has taken and continues to take reasonable steps to provide representative and accurate information but may not have conducted destructive testing or chemical analysis on incoming materials and chemicals. TI and TI suppliers consider certain information to be proprietary, and thus CAS numbers and other limited information may not be available for release.

In no event shall TI's liability arising out of such information exceed the total purchase price of the TI part(s) at issue in this document sold by TI to Customer on an annual basis.

**TAPE AND REEL INFORMATION**

**QUADRANT ASSIGNMENTS FOR PIN 1 ORIENTATION IN TAPE**


\*All dimensions are nominal

| Device               | Package Type | Package Drawing | Pins | SPQ  | Reel Diameter (mm) | Reel Width W1 (mm) | A0 (mm) | B0 (mm) | K0 (mm) | P1 (mm) | W (mm) | Pin1 Quadrant |
|----------------------|--------------|-----------------|------|------|--------------------|--------------------|---------|---------|---------|---------|--------|---------------|
| LP2982AIM5-3.0/NOPB  | SOT-23       | DBV             | 5    | 1000 | 178.0              | 8.4                | 3.2     | 3.2     | 1.4     | 4.0     | 8.0    | Q3            |
| LP2982AIM5-3.3/NOPB  | SOT-23       | DBV             | 5    | 3000 | 180.0              | 8.4                | 3.2     | 3.2     | 1.4     | 4.0     | 8.0    | Q3            |
| LP2982AIM5-5.0/NOPB  | SOT-23       | DBV             | 5    | 3000 | 180.0              | 8.4                | 3.2     | 3.2     | 1.4     | 4.0     | 8.0    | Q3            |
| LP2982AIM5X-3.0/NOPB | SOT-23       | DBV             | 5    | 3000 | 178.0              | 8.4                | 3.2     | 3.2     | 1.4     | 4.0     | 8.0    | Q3            |
| LP2982AIM5X-3.3/NOPB | SOT-23       | DBV             | 5    | 3000 | 178.0              | 8.4                | 3.2     | 3.2     | 1.4     | 4.0     | 8.0    | Q3            |
| LP2982AIM5X-5.0/NOPB | SOT-23       | DBV             | 5    | 3000 | 180.0              | 8.4                | 3.2     | 3.2     | 1.4     | 4.0     | 8.0    | Q3            |
| LP2982IM5-3.0/NOPB   | SOT-23       | DBV             | 5    | 1000 | 178.0              | 8.4                | 3.2     | 3.2     | 1.4     | 4.0     | 8.0    | Q3            |
| LP2982IM5-3.3/NOPB   | SOT-23       | DBV             | 5    | 3000 | 180.0              | 8.4                | 3.2     | 3.2     | 1.4     | 4.0     | 8.0    | Q3            |
| LP2982IM5-5.0/NOPB   | SOT-23       | DBV             | 5    | 3000 | 180.0              | 8.4                | 3.2     | 3.2     | 1.4     | 4.0     | 8.0    | Q3            |
| LP2982IM5X-3.0/NOPB  | SOT-23       | DBV             | 5    | 3000 | 180.0              | 8.4                | 3.2     | 3.2     | 1.4     | 4.0     | 8.0    | Q3            |
| LP2982IM5X-3.3/NOPB  | SOT-23       | DBV             | 5    | 3000 | 180.0              | 8.4                | 3.2     | 3.2     | 1.4     | 4.0     | 8.0    | Q3            |
| LP2982IM5X-5.0/NOPB  | SOT-23       | DBV             | 5    | 3000 | 178.0              | 8.4                | 3.2     | 3.2     | 1.4     | 4.0     | 8.0    | Q3            |

## TAPE AND REEL BOX DIMENSIONS



\*All dimensions are nominal

| Device               | Package Type | Package Drawing | Pins | SPQ  | Length (mm) | Width (mm) | Height (mm) |
|----------------------|--------------|-----------------|------|------|-------------|------------|-------------|
| LP2982AIM5-3.0/NOPB  | SOT-23       | DBV             | 5    | 1000 | 208.0       | 191.0      | 35.0        |
| LP2982AIM5-3.3/NOPB  | SOT-23       | DBV             | 5    | 3000 | 210.0       | 185.0      | 35.0        |
| LP2982AIM5-5.0/NOPB  | SOT-23       | DBV             | 5    | 3000 | 210.0       | 185.0      | 35.0        |
| LP2982AIM5X-3.0/NOPB | SOT-23       | DBV             | 5    | 3000 | 208.0       | 191.0      | 35.0        |
| LP2982AIM5X-3.3/NOPB | SOT-23       | DBV             | 5    | 3000 | 208.0       | 191.0      | 35.0        |
| LP2982AIM5X-5.0/NOPB | SOT-23       | DBV             | 5    | 3000 | 210.0       | 185.0      | 35.0        |
| LP2982IM5-3.0/NOPB   | SOT-23       | DBV             | 5    | 1000 | 208.0       | 191.0      | 35.0        |
| LP2982IM5-3.3/NOPB   | SOT-23       | DBV             | 5    | 3000 | 210.0       | 185.0      | 35.0        |
| LP2982IM5-5.0/NOPB   | SOT-23       | DBV             | 5    | 3000 | 210.0       | 185.0      | 35.0        |
| LP2982IM5X-3.0/NOPB  | SOT-23       | DBV             | 5    | 3000 | 210.0       | 185.0      | 35.0        |
| LP2982IM5X-3.3/NOPB  | SOT-23       | DBV             | 5    | 3000 | 210.0       | 185.0      | 35.0        |
| LP2982IM5X-5.0/NOPB  | SOT-23       | DBV             | 5    | 3000 | 208.0       | 191.0      | 35.0        |



# EXAMPLE BOARD LAYOUT

DBV0005A

SOT-23 - 1.45 mm max height

SMALL OUTLINE TRANSISTOR



LAND PATTERN EXAMPLE  
EXPOSED METAL SHOWN  
SCALE:15X



SOLDER MASK DETAILS

4214839/K 08/2024

NOTES: (continued)

- 6. Publication IPC-7351 may have alternate designs.
- 7. Solder mask tolerances between and around signal pads can vary based on board fabrication site.

# EXAMPLE STENCIL DESIGN

DBV0005A

SOT-23 - 1.45 mm max height

SMALL OUTLINE TRANSISTOR



SOLDER PASTE EXAMPLE  
BASED ON 0.125 mm THICK STENCIL  
SCALE:15X

4214839/K 08/2024

NOTES: (continued)

8. Laser cutting apertures with trapezoidal walls and rounded corners may offer better paste release. IPC-7525 may have alternate design recommendations.
9. Board assembly site may have different recommendations for stencil design.

## IMPORTANT NOTICE AND DISCLAIMER

TI PROVIDES TECHNICAL AND RELIABILITY DATA (INCLUDING DATA SHEETS), DESIGN RESOURCES (INCLUDING REFERENCE DESIGNS), APPLICATION OR OTHER DESIGN ADVICE, WEB TOOLS, SAFETY INFORMATION, AND OTHER RESOURCES "AS IS" AND WITH ALL FAULTS, AND DISCLAIMS ALL WARRANTIES, EXPRESS AND IMPLIED, INCLUDING WITHOUT LIMITATION ANY IMPLIED WARRANTIES OF MERCHANTABILITY, FITNESS FOR A PARTICULAR PURPOSE OR NON-INFRINGEMENT OF THIRD PARTY INTELLECTUAL PROPERTY RIGHTS.

These resources are intended for skilled developers designing with TI products. You are solely responsible for (1) selecting the appropriate TI products for your application, (2) designing, validating and testing your application, and (3) ensuring your application meets applicable standards, and any other safety, security, regulatory or other requirements.

These resources are subject to change without notice. TI grants you permission to use these resources only for development of an application that uses the TI products described in the resource. Other reproduction and display of these resources is prohibited. No license is granted to any other TI intellectual property right or to any third party intellectual property right. TI disclaims responsibility for, and you will fully indemnify TI and its representatives against, any claims, damages, costs, losses, and liabilities arising out of your use of these resources.

TI's products are provided subject to [TI's Terms of Sale](#) or other applicable terms available either on [ti.com](https://www.ti.com) or provided in conjunction with such TI products. TI's provision of these resources does not expand or otherwise alter TI's applicable warranties or warranty disclaimers for TI products.

TI objects to and rejects any additional or different terms you may have proposed.

Mailing Address: Texas Instruments, Post Office Box 655303, Dallas, Texas 75265  
Copyright © 2024, Texas Instruments Incorporated