

Linear Regulator – Low Dropout, Low I_Q

NCV4264-2

The NCV4264-2 is functionally and pin for pin compatible with NCV4264 with a lower quiescent current consumption. Its output stage supplies 100 mA with ±2.0% output voltage accuracy.

Maximum dropout voltage is 500 mV at 100 mA load current.

It is internally protected against 45 V input transients, input supply reversal, output overcurrent faults, and excess die temperature. No external components are required to enable these features.

Features

- 3.3 V and 5.0 V Fixed Output
- ±2.0% Output Accuracy, Over Full Temperature Range
- 60 µA Maximum Quiescent Current at I_{OUT} = 100 µA
- 500 mV Maximum Dropout Voltage at 100 mA Load Current
- Wide Input Voltage Operating Range of 4.5 V to 45 V
- Internal Fault Protection
 - ◆ -42 V Reverse Voltage
 - ◆ Short Circuit/Overcurrent
 - ◆ Thermal Overload
- NCV Prefix for Automotive and Other Applications Requiring Unique Site and Control Change Requirements; AEC-Q100 Qualified and PPAP Capable
- This is a Pb-Free Device

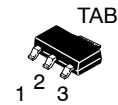

SOT-223
ST SUFFIX
CASE 318E



SOIC-8 Fused
CASE 751

PIN CONNECTIONS

(SOT-223)		(SOIC-8 Fused)	
PIN	FUNCTION	PIN	FUNCTION
1	V _{IN}	1	NC
2, TAB	GND	2,	V _{IN}
3	V _{OUT}	3	GND
		4,	V _{OUT}
		5-8.	NC

MARKING DIAGRAM

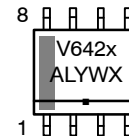
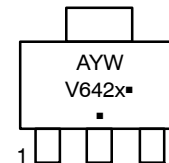

- x = 5 (5.0 V Version)
3 (3.3 V Version)
- A = Assembly Location
- L = Wafer Lot
- Y = Year
- W = Work Week
- = Pb-Free Package

(Note: Microdot may be in either location)

ORDERING INFORMATION

See detailed ordering and shipping information in the package dimensions section on page 9 of this data sheet.

NCV4264-2

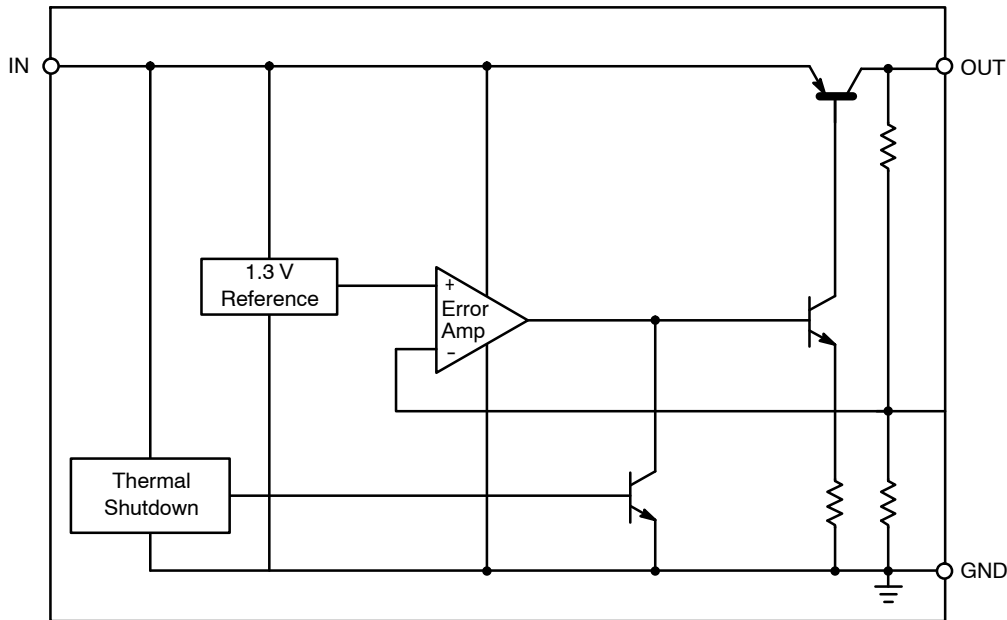

Figure 1. Block Diagram

PIN FUNCTION DESCRIPTION

Symbol	Pin No.		Function
	SOT-223	SOIC-8	
V _{IN}	1	2	Unregulated input voltage; 4.5 V to 45 V.
GND	2	3	Ground; substrate.
V _{OUT}	3	4	Regulated output voltage; collector of the internal PNP pass transistor.
GND	TAB	-	Ground; substrate and best thermal connection to the die.
NC	-	1, 5-8	No Connection.

OPERATING RANGE

Symbol	Rating	Min	Max	Unit
V _{IN}	V _{IN} , DC Input Operating Voltage (Note 3)	4.5	+45	V
T _J	Junction Temperature Operating Range	-40	+150	°C

MAXIMUM RATINGS

Symbol	Rating	Min	Max	Unit
V _{IN}	V _{IN} , DC Input Voltage	-42	+45	V
V _{OUT}	V _{OUT} , DC Voltage	-0.3	+18	V
T _{stg}	Storage Temperature	-55	+150	°C
MSL	Moisture Sensitivity Level SOT223 SOIC-8 Fused	3 1		-
V _{ESDHB}	ESD Capability, Human Body Model (Note 1)	4000	-	V
V _{ESDMIM}	ESD Capability, Machine Model (Note 1)	200	-	V
T _{slid}	Lead Temperature Soldering Reflow (SMD Styles Only), Lead Free (Note 2)	-	265 pk	°C

Stresses exceeding those listed in the Maximum Ratings table may damage the device. If any of these limits are exceeded, device functionality should not be assumed, damage may occur and reliability may be affected.

1. This device series incorporates ESD protection and is tested by the following methods:

ESD HBM tested per AEC-Q100-002 (EIA/JESD22-A 114C)

ESD MM tested per AEC-Q100-003 (EIA/JESD22-A 115C)

2. Lead Free, 60 sec – 150 sec above 217°C, 40 sec max at peak.

3. See specific conditions for DC operating input voltage lower than 4.5 V in the ELECTRICAL CHARACTERISTICS table at page 3

NCV4264-2

THERMAL RESISTANCE

Symbol	Parameter	Min	Max	Unit
$R_{\theta JA}$	Junction-to-Ambient SOT-223 SOIC-8 Fused	-	99 (Note 4) 145	°C/W
$R_{\theta JC}$	Junction-to-Case SOT-223 SOIC-8 Fused	-	17 -	

ELECTRICAL CHARACTERISTICS ($V_{IN} = 13.5\text{ V}$, $T_J = -40^\circ\text{C}$ to $+150^\circ\text{C}$, unless otherwise noted.)

Symbol	Characteristic	Test Conditions	Min	Typ	Max	Unit
V_{OUT}	Output Voltage 5.0 V Version	$5.0\text{ mA} \leq I_{OUT} \leq 100\text{ mA}$ (Note 5) $6.0\text{ V} \leq V_{IN} \leq 28\text{ V}$	4.900	5.000	5.100	V
V_{OUT}	Output Voltage 3.3 V Version	$5.0\text{ mA} \leq I_{OUT} \leq 100\text{ mA}$ (Note 5) $4.5\text{ V} \leq V_{IN} \leq 28\text{ V}$	3.234	3.300	3.366	V
V_{OUT}	Output Voltage 3.3 V Version	$I_{OUT} = 5\text{ mA}$, $V_{IN} = 4\text{ V}$ (Note 7)	3.234	3.300	3.366	V
ΔV_{OUT} vs. V_{IN}	Line Regulation 5.0 V Version	$I_{OUT} = 5.0\text{ mA}$ $6.0\text{ V} \leq V_{IN} \leq 28\text{ V}$	-30	5.0	+30	mV
ΔV_{OUT} vs. V_{IN}	Line Regulation 3.3 V Version	$I_{OUT} = 5.0\text{ mA}$ $4.5\text{ V} \leq V_{IN} \leq 28\text{ V}$	-30	5.0	+30	mV
ΔV_{OUT} vs. I_{OUT}	Load Regulation	$1.0\text{ mA} \leq I_{OUT} \leq 100\text{ mA}$ (Note 5)	-40	5.0	+40	mV
$V_{IN}-V_{OUT}$	Dropout Voltage - 5.0 V Version	$I_{OUT} = 100\text{ mA}$ (Notes 5 & 6)	-	270	500	mV
$V_{IN}-V_{OUT}$	Dropout Voltage - 3.3 V Version	$I_{OUT} = 100\text{ mA}$ (Notes 5 & 8)	-	-	1,266	V
I_q	Quiescent Current	$I_{OUT} = 100\text{ }\mu\text{A}$ $T_J = 25^\circ\text{C}$ $T_J = -40^\circ\text{C}$ to $+85^\circ\text{C}$ $T_J = -40^\circ\text{C}$ to 150°C	-	33 33 33	55 60 70	μA
$I_{G(ON)}$	Active Ground Current	$I_{OUT} = 50\text{ mA}$ (Note 5)	-	1.5	4.0	mA
PSRR	Power Supply Rejection	$V_{RIPPLE} = 0.5\text{ V}_{P-P}$, $F = 100\text{ Hz}$	-	67	-	dB
C_{OUT} ESR	Output Capacitor for Stability 5.0 V Version	$I_{OUT} = 0.1\text{ mA}$ to 100 mA (Notes 5 & 7)	10 -	- -	- 9.0	μF Ω
C_{OUT} ESR	Output Capacitor for Stability 3.3 V Version	$I_{OUT} = 0.1\text{ mA}$ to 100 mA (Notes 5 & 7)	22 -	- -	- 16	μF Ω

PROTECTION PROTECTION

$I_{OUT(LIM)}$	Current Limit	$V_{OUT} = 4.5\text{ V}$ (5.0 V Version) (Note 5) $V_{OUT} = 3.0\text{ V}$ (3.3 V Version) (Note 5)	150 150	- -	500 500	mA
$I_{OUT(SC)}$	Short Circuit Current Limit	$V_{OUT} = 0\text{ V}$ (Note 5)	40	-	500	mA
T_{TSD}	Thermal Shutdown Threshold	(Note 7)	150	-	200	°C

Product parametric performance is indicated in the Electrical Characteristics for the listed test conditions, unless otherwise noted. Product performance may not be indicated by the Electrical Characteristics if operated under different conditions.

4. 1 oz., 100 mm² copper area.

5. Use pulse loading to limit power dissipation.

6. Dropout voltage = ($V_{IN}-V_{OUT}$), measured when the output voltage has dropped 100 mV relative to the nominal value obtained with $V_{IN} = 13.5\text{ V}$.

7. Not tested in production. Limits are guaranteed by design.

8. $V_{DO} = V_{IN} - V_{OUT}$. For output voltage set to < 4.5 V, V_{DO} will be constrained by the minimum input voltage.

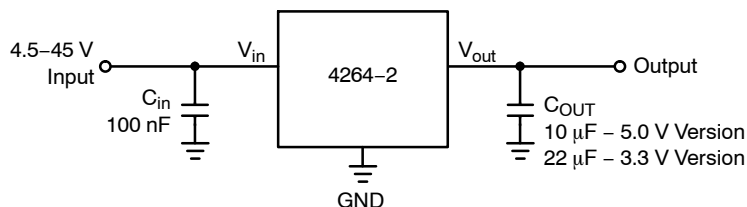

Figure 2. Applications Circuit

TYPICAL CHARACTERISTIC CURVES - 5 V VERSION

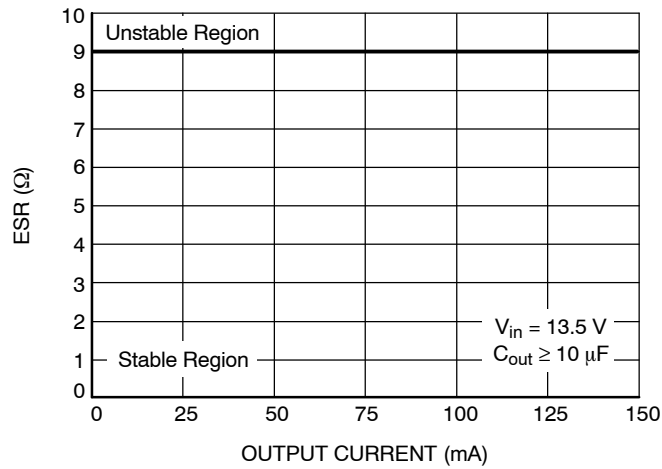

Figure 3. ESR Stability vs. Output Current (5 V Version)

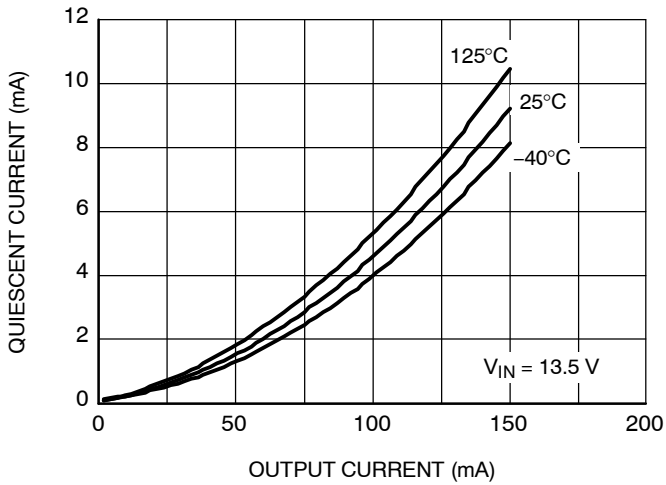

Figure 4. Quiescent Current vs. Output Current (5 V Version)

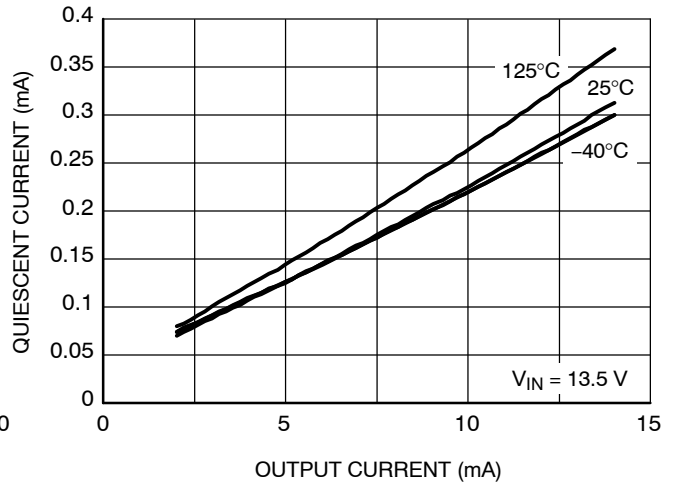

Figure 5. Quiescent Current vs. Output Current (Light Load) (5 V Version)

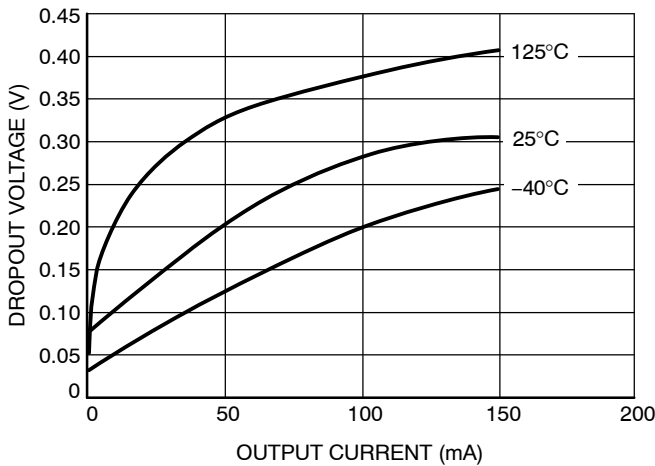

Figure 6. Dropout Voltage vs. Output Current (5 V Version)

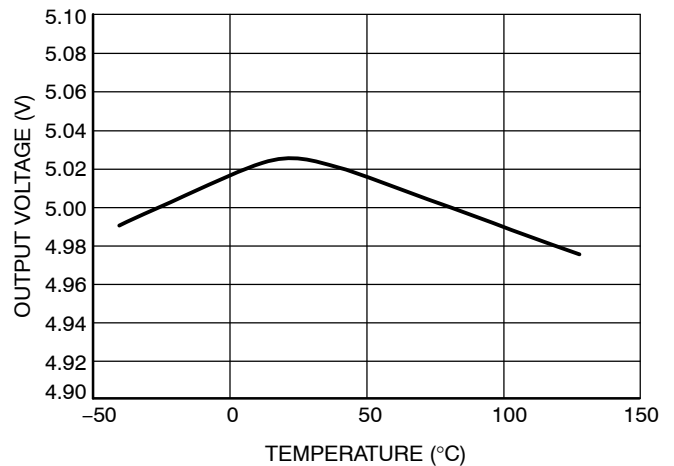

Figure 7. Output Voltage vs. Temperature (5 V Version)

TYPICAL CHARACTERISTIC CURVES – 5 V VERSION (continued)

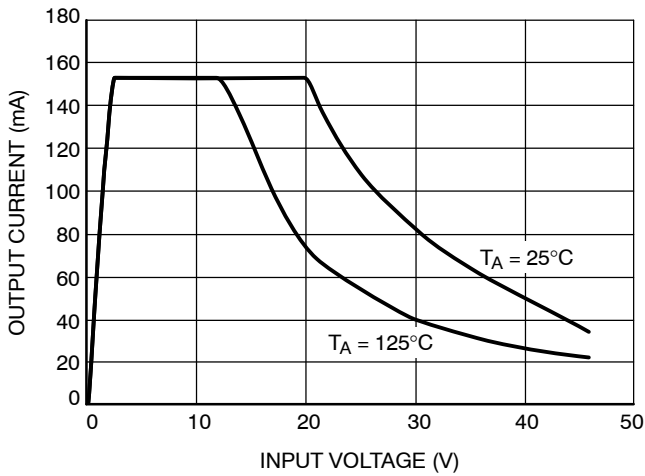

Figure 8. Output Current vs. Input Voltage (5 V Version)

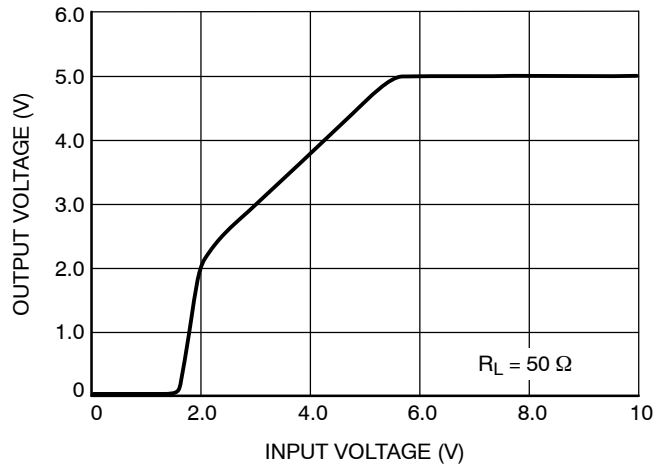

Figure 9. Output Voltage vs. Input Voltage (5 V Version)

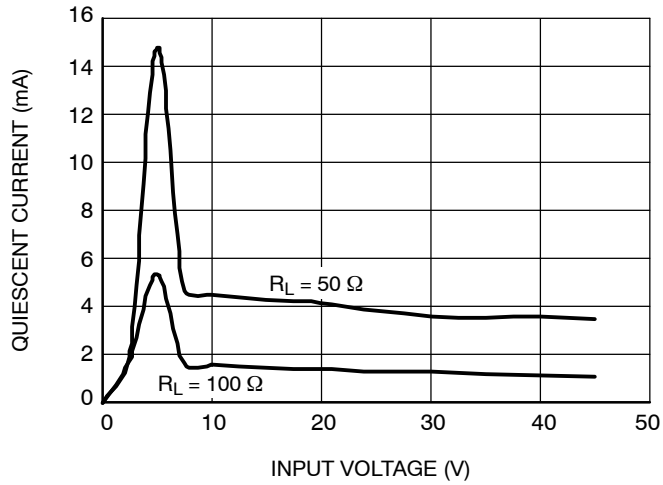

Figure 10. Quiescent Current vs. Input Voltage (5 V Version)

TYPICAL CHARACTERISTIC CURVES - 3.3 V VERSION

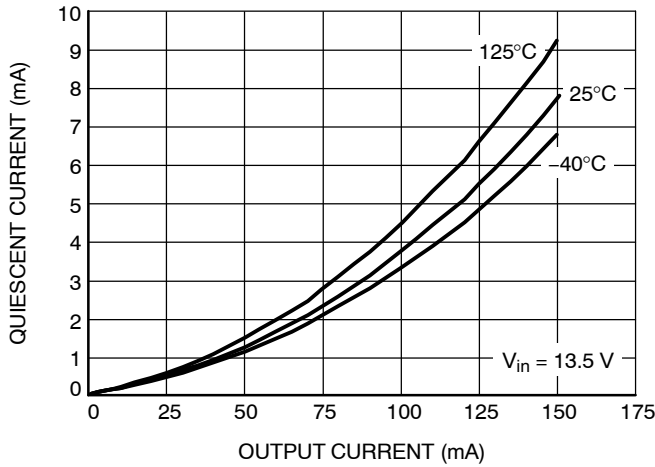

Figure 11. Quiescent Current vs. Output Current (3.3 V Version)

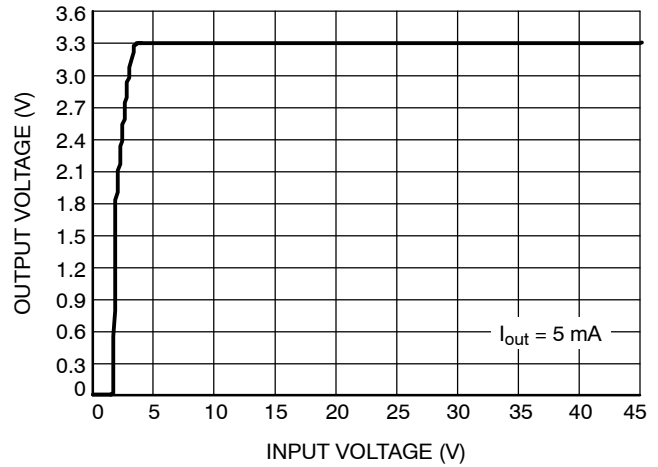

Figure 12. Output Voltage vs. Input Voltage (3.3 V Version)

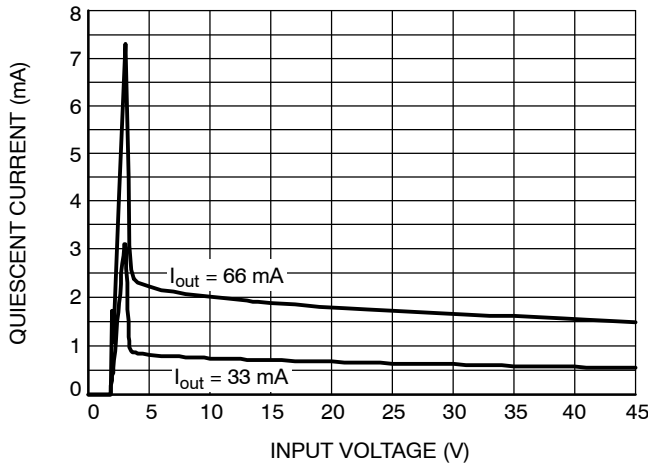

Figure 13. Quiescent Current vs. Input Voltage (3.3 V Version)

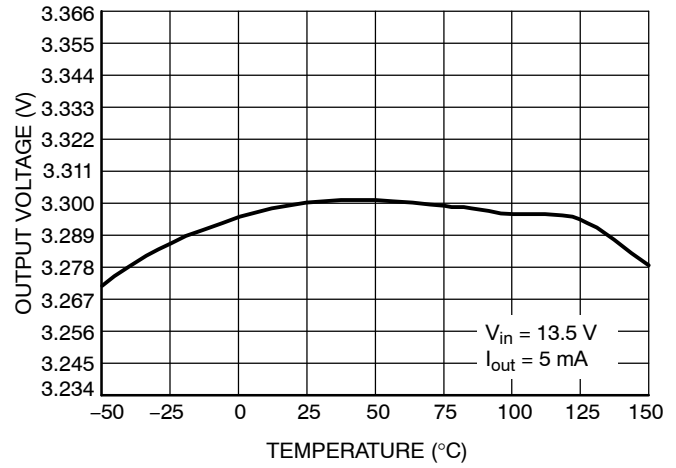

Figure 14. Output Voltage vs. Temperature (3.3 V Version)

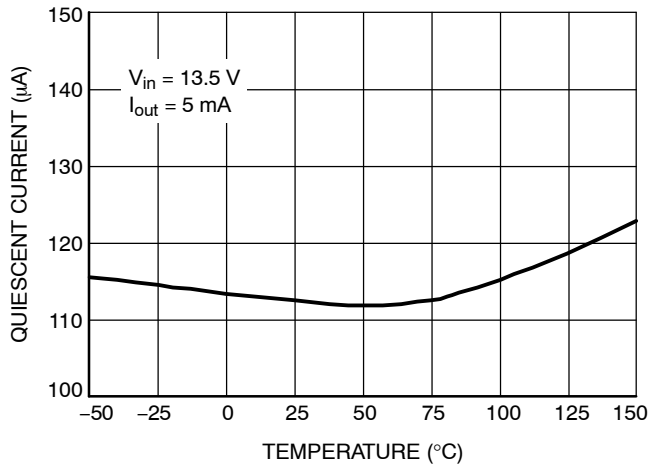

Figure 15. Quiescent Current vs. Temperature (3.3 V Version)

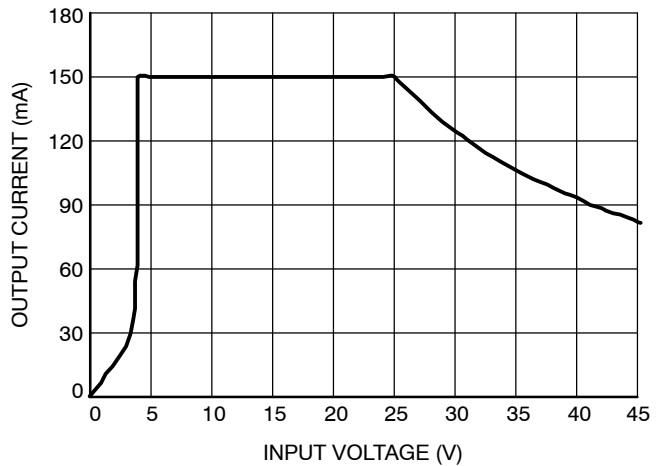

Figure 16. Output Current vs. Input Voltage (3.3 V Version)

TYPICAL CHARACTERISTIC CURVES – 3.3 V VERSION (continued)

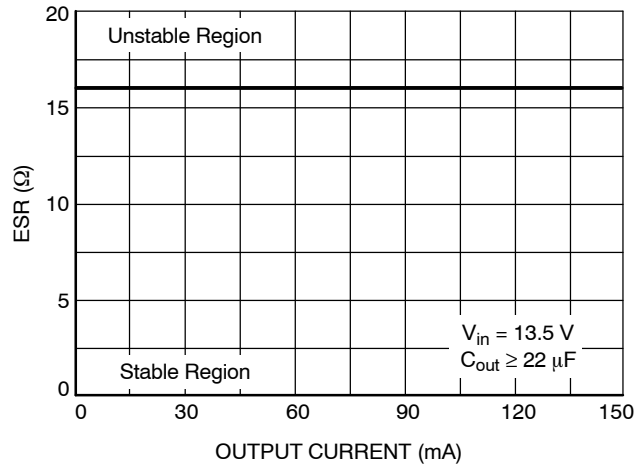

Figure 17. ESR Stability vs. Output Current (3.3 V Version)

Circuit Description

The NCV4264–2 is functionally and pin for pin compatible with NCV4264 with a lower quiescent current consumption. Its output stage supplies 100 mA with ±2.0% output voltage accuracy.

Maximum dropout voltage is 500 mV at 100 mA load current. It is internally protected against 45 V input transients, input supply reversal, output overcurrent faults, and excess die temperature. No external components are required to enable these features.

Regulator

The error amplifier compares the reference voltage to a sample of the output voltage (V_{OUT}) and drives the base of a PNP series pass transistor by a buffer. The reference is a bandgap design to give it a temperature–stable output. Saturation control of the PNP is a function of the load current and input voltage. Oversaturation of the output power device is prevented, and quiescent current in the ground pin is minimized.

Regulator Stability Considerations

The input capacitor C_{I1} in Figure 2 is necessary for compensating input line reactance. Possible oscillations caused by input inductance and input capacitance can be damped by using a resistor of approximately 1 Ω in series with C_{I2}. The output or compensation capacitor, C_{OUT} helps determine three main characteristics of a linear regulator: startup delay, load transient response and loop stability. Tantalum, aluminum electrolytic, film, or ceramic capacitors are all acceptable solutions, however, attention must be paid to ESR constraints. The capacitor manufacturer’s data sheet usually provides this information. The value for the output capacitor C_{OUT} shown in Figure 2 should work for most applications; however, it is not necessarily the optimized solution. Stability is guaranteed at values of C_Q ≥ 10 μF, with an ESR ≤ 9 Ω for the 5.0 V Version, and C_Q ≥ 22 μF with an ESR ≤ 16 Ω for the 3.3 V Version within the operating temperature range. Actual limits are shown in a graph in the Typical Performance Characteristics section.

Calculating Power Dissipation in a Single Output Linear Regulator

The maximum power dissipation for a single output regulator (Figure 2) is:

$$P_{D(max)} = [V_{IN(max)} - V_{OUT(min)}] * I_{OUT(max)} + V_{IN(max)} * I_q \tag{eq. 1}$$

Where:

V_{IN(max)} is the maximum input voltage,

V_{OUT(min)} is the minimum output voltage,

I_{OUT(max)} is the maximum output current for the application, and I_q is the quiescent current the regulator consumes at I_{OUT(max)}. Once the value of P_{D(max)} is known, the maximum permissible value of R_{θJA} can be calculated:

$$R_{\theta JA} = \frac{(150^\circ C - T_A)}{P_D} \tag{eq. 2}$$

The value of R_{θJA} can then be compared with those in the package section of the data sheet. Those packages with R_{θJA}’s less than the calculated value in Equation 2 will keep the die temperature below 150°C. In some cases, none of the packages will be sufficient to dissipate the heat generated by the IC, and an external heat sink will be required. The current flow and voltages are shown in the Measurement Circuit Diagram.

Heat Sinks

A heat sink effectively increases the surface area of the package to improve the flow of heat away from the IC and into the surrounding air. Each material in the heat flow path between the IC and the outside environment will have a thermal resistance. Like series electrical resistances, these resistances are summed to determine the value of R_{θJA}:

$$R_{\theta JA} = R_{\theta JC} + R_{\theta CS} + R_{\theta SA} \tag{eq. 3}$$

Where:

R_{θJC} = the junction–to–case thermal resistance,

R_{θCS} = the case–to–heat sink thermal resistance, and

R_{θSA} = the heat sink–to–ambient thermal resistance.

R_{θJA} appears in the package section of the data sheet. Like R_{θJA}, it too is a function of package type. R_{θCS} and R_{θSA} are functions of the package type, heat sink and the interface between them. These values appear in data sheets of heat sink manufacturers. Thermal, mounting, and heat sinking are discussed in the **onsemi** application note [AN1040/D](#), available on the **onsemi** Website.

NCV4264-2

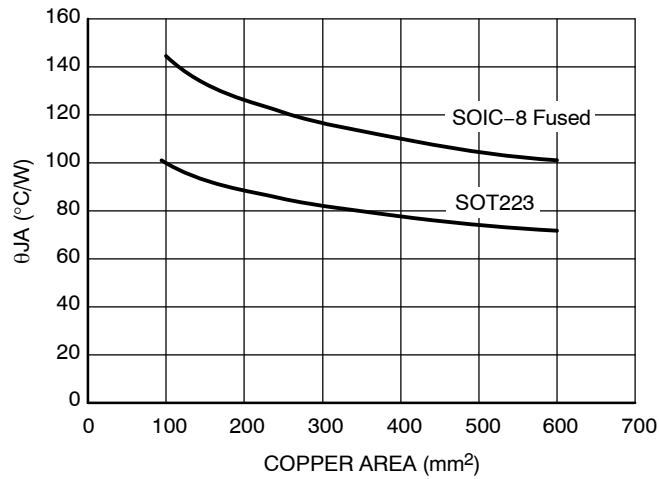

Figure 18. θ_{JA} vs. Copper Spreader Area

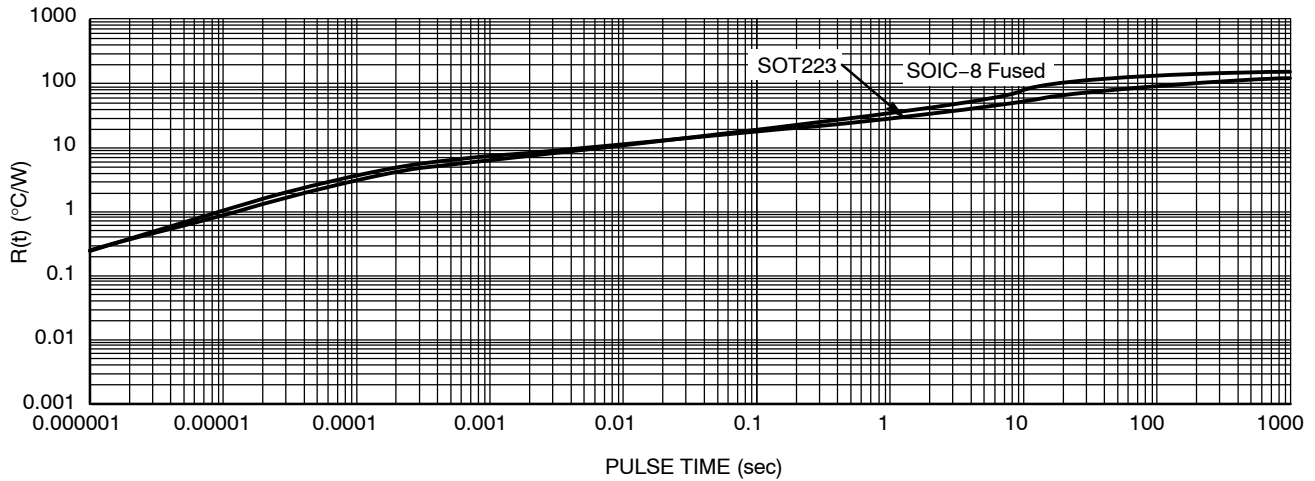

Figure 19. $R(t)$ vs. Pulse Time

ORDERING INFORMATION

Device*	Package	Shipping†
NCV4264-2ST50T3G	SOT-223 (Pb-Free)	4000 / Tape & Reel
NCV4264-2ST33T3G	SOT-223 (Pb-Free)	4000 / Tape & Reel
NCV4264-2D33R2G	SOIC-8 Fused (Pb-Free)	2500 / Tape & Reel

†For information on tape and reel specifications, including part orientation and tape sizes, please refer to our Tape and Reel Packaging Specification Brochure, [BRD8011/D](#).

*NCV Prefix for Automotive and Other Applications Requiring Unique Site and Control Change Requirements; AEC-Q100 Qualified and PPAP Capable.



SCALE 1:1

SOT-223 (TO-261)
CASE 318E-04
ISSUE R

DATE 02 OCT 2018

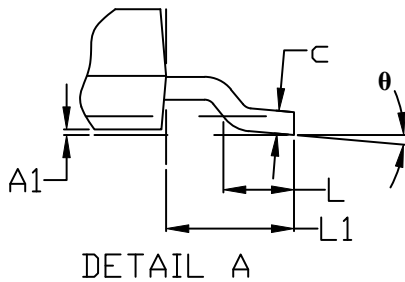
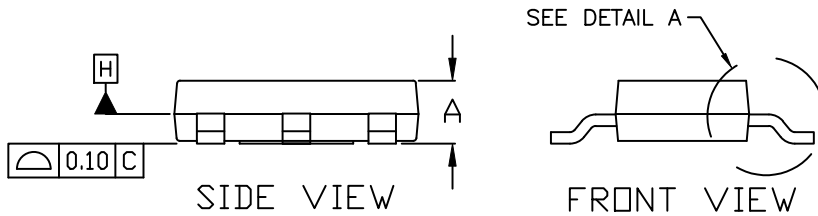
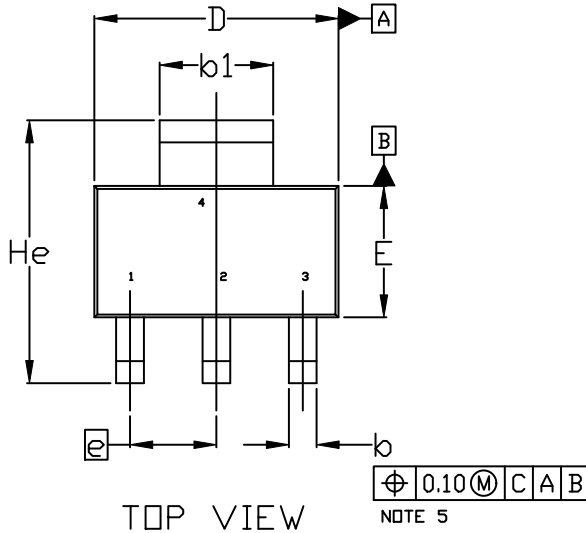

NOTES:

1. DIMENSIONING AND TOLERANCING PER ASME Y14.5M, 1994.
2. CONTROLLING DIMENSION: MILLIMETERS
3. DIMENSIONS D & E DO NOT INCLUDE MOLD FLASH, PROTRUSIONS OR GATE BURRS. MOLD FLASH, PROTRUSIONS OR GATE BURRS SHALL NOT EXCEED 0.200MM PER SIDE.
4. DATUMS A AND B ARE DETERMINED AT DATUM H.
5. A1 IS DEFINED AS THE VERTICAL DISTANCE FROM THE SEATING PLANE TO THE LOWEST POINT OF THE PACKAGE BODY.
6. POSITIONAL TOLERANCE APPLIES TO DIMENSIONS b AND b1.

MILLIMETERS			
DIM	MIN.	NOM.	MAX.
A	1.50	1.63	1.75
A1	0.02	0.06	0.10
b	0.60	0.75	0.89
b1	2.90	3.06	3.20
c	0.24	0.29	0.35
D	6.30	6.50	6.70
E	3.30	3.50	3.70
e	2.30 BSC		
L	0.20	---	---
L1	1.50	1.75	2.00
He	6.70	7.00	7.30
θ	0°	---	10°

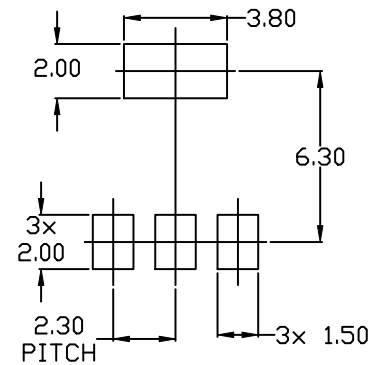

DOCUMENT NUMBER:	98ASB42680B	Electronic versions are uncontrolled except when accessed directly from the Document Repository. Printed versions are uncontrolled except when stamped "CONTROLLED COPY" in red.
DESCRIPTION:	SOT-223 (TO-261)	PAGE 1 OF 2

onsemi and ONSEMI are trademarks of Semiconductor Components Industries, LLC dba onsemi or its subsidiaries in the United States and/or other countries. onsemi reserves the right to make changes without further notice to any products herein. onsemi makes no warranty, representation or guarantee regarding the suitability of its products for any particular purpose, nor does onsemi assume any liability arising out of the application or use of any product or circuit, and specifically disclaims any and all liability, including without limitation special, consequential or incidental damages. onsemi does not convey any license under its patent rights nor the rights of others.

**SOT-223 (TO-261)
CASE 318E-04
ISSUE R**

DATE 02 OCT 2018

- | | | | | |
|--|---|---|---|---|
| <p>STYLE 1:
PIN 1. BASE
2. COLLECTOR
3. EMITTER
4. COLLECTOR</p> | <p>STYLE 2:
PIN 1. ANODE
2. CATHODE
3. NC
4. CATHODE</p> | <p>STYLE 3:
PIN 1. GATE
2. DRAIN
3. SOURCE
4. DRAIN</p> | <p>STYLE 4:
PIN 1. SOURCE
2. DRAIN
3. GATE
4. DRAIN</p> | <p>STYLE 5:
PIN 1. DRAIN
2. GATE
3. SOURCE
4. GATE</p> |
| <p>STYLE 6:
PIN 1. RETURN
2. INPUT
3. OUTPUT
4. INPUT</p> | <p>STYLE 7:
PIN 1. ANODE 1
2. CATHODE
3. ANODE 2
4. CATHODE</p> | <p>STYLE 8:
CANCELLED</p> | <p>STYLE 9:
PIN 1. INPUT
2. GROUND
3. LOGIC
4. GROUND</p> | <p>STYLE 10:
PIN 1. CATHODE
2. ANODE
3. GATE
4. ANODE</p> |
| <p>STYLE 11:
PIN 1. MT 1
2. MT 2
3. GATE
4. MT 2</p> | <p>STYLE 12:
PIN 1. INPUT
2. OUTPUT
3. NC
4. OUTPUT</p> | <p>STYLE 13:
PIN 1. GATE
2. COLLECTOR
3. EMITTER
4. COLLECTOR</p> | | |

**GENERIC
MARKING DIAGRAM***

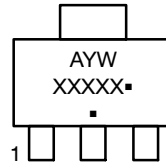

- A = Assembly Location
- Y = Year
- W = Work Week
- XXXXX = Specific Device Code
- = Pb-Free Package

(Note: Microdot may be in either location)

*This information is generic. Please refer to device data sheet for actual part marking. Pb-Free indicator, "G" or microdot "▪", may or may not be present. Some products may not follow the Generic Marking.

DOCUMENT NUMBER:	98ASB42680B	Electronic versions are uncontrolled except when accessed directly from the Document Repository. Printed versions are uncontrolled except when stamped "CONTROLLED COPY" in red.
DESCRIPTION:	SOT-223 (TO-261)	PAGE 2 OF 2

onsemi and **ONSEMI** are trademarks of Semiconductor Components Industries, LLC dba **onsemi** or its subsidiaries in the United States and/or other countries. **onsemi** reserves the right to make changes without further notice to any products herein. **onsemi** makes no warranty, representation or guarantee regarding the suitability of its products for any particular purpose, nor does **onsemi** assume any liability arising out of the application or use of any product or circuit, and specifically disclaims any and all liability, including without limitation special, consequential or incidental damages. **onsemi** does not convey any license under its patent rights nor the rights of others.

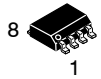

SCALE 1:1

SOIC-8 NB
CASE 751-07
ISSUE AK

DATE 16 FEB 2011

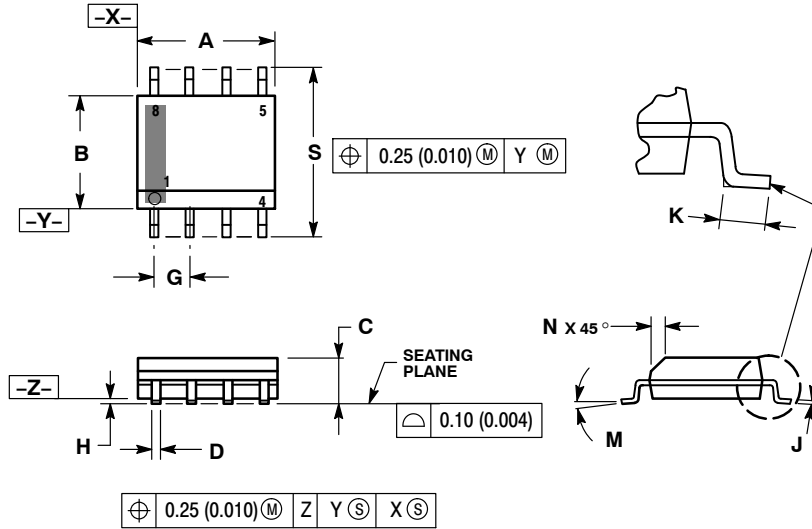

- NOTES:
1. DIMENSIONING AND TOLERANCING PER ANSI Y14.5M, 1982.
 2. CONTROLLING DIMENSION: MILLIMETER.
 3. DIMENSION A AND B DO NOT INCLUDE MOLD PROTRUSION.
 4. MAXIMUM MOLD PROTRUSION 0.15 (0.006) PER SIDE.
 5. DIMENSION D DOES NOT INCLUDE DAMBAR PROTRUSION. ALLOWABLE DAMBAR PROTRUSION SHALL BE 0.127 (0.005) TOTAL IN EXCESS OF THE D DIMENSION AT MAXIMUM MATERIAL CONDITION.
 6. 751-01 THRU 751-06 ARE OBSOLETE. NEW STANDARD IS 751-07.

DIM	MILLIMETERS		INCHES	
	MIN	MAX	MIN	MAX
A	4.80	5.00	0.189	0.197
B	3.80	4.00	0.150	0.157
C	1.35	1.75	0.053	0.069
D	0.33	0.51	0.013	0.020
G	1.27 BSC		0.050 BSC	
H	0.10	0.25	0.004	0.010
J	0.19	0.25	0.007	0.010
K	0.40	1.27	0.016	0.050
M	0°	8°	0°	8°
N	0.25	0.50	0.010	0.020
S	5.80	6.20	0.228	0.244

SOLDERING FOOTPRINT*



*For additional information on our Pb-Free strategy and soldering details, please download the onsemi Soldering and Mounting Techniques Reference Manual, SOLDERRM/D.

GENERIC MARKING DIAGRAM*



XXXXXX = Specific Device Code
A = Assembly Location
L = Wafer Lot
Y = Year
W = Work Week
▪ = Pb-Free Package

XXXXXX = Specific Device Code
A = Assembly Location
Y = Year
WW = Work Week
▪ = Pb-Free Package

*This information is generic. Please refer to device data sheet for actual part marking. Pb-Free indicator, "G" or microdot "▪", may or may not be present. Some products may not follow the Generic Marking.

STYLES ON PAGE 2

DOCUMENT NUMBER:	98ASB42564B	Electronic versions are uncontrolled except when accessed directly from the Document Repository. Printed versions are uncontrolled except when stamped "CONTROLLED COPY" in red.
DESCRIPTION:	SOIC-8 NB	PAGE 1 OF 2

onsemi and ONSEMI are trademarks of Semiconductor Components Industries, LLC dba onsemi or its subsidiaries in the United States and/or other countries. onsemi reserves the right to make changes without further notice to any products herein. onsemi makes no warranty, representation or guarantee regarding the suitability of its products for any particular purpose, nor does onsemi assume any liability arising out of the application or use of any product or circuit, and specifically disclaims any and all liability, including without limitation special, consequential or incidental damages. onsemi does not convey any license under its patent rights nor the rights of others.

SOIC-8 NB
CASE 751-07
ISSUE AK

DATE 16 FEB 2011

- | | | | |
|---|--|--|--|
| <p>STYLE 1:
 PIN 1. EMITTER
 2. COLLECTOR
 3. COLLECTOR
 4. EMITTER
 5. EMITTER
 6. BASE
 7. BASE
 8. EMITTER</p> | <p>STYLE 2:
 PIN 1. COLLECTOR, DIE, #1
 2. COLLECTOR, #1
 3. COLLECTOR, #2
 4. COLLECTOR, #2
 5. BASE, #2
 6. EMITTER, #2
 7. BASE, #1
 8. EMITTER, #1</p> | <p>STYLE 3:
 PIN 1. DRAIN, DIE #1
 2. DRAIN, #1
 3. DRAIN, #2
 4. DRAIN, #2
 5. GATE, #2
 6. SOURCE, #2
 7. GATE, #1
 8. SOURCE, #1</p> | <p>STYLE 4:
 PIN 1. ANODE
 2. ANODE
 3. ANODE
 4. ANODE
 5. ANODE
 6. ANODE
 7. ANODE
 8. COMMON CATHODE</p> |
| <p>STYLE 5:
 PIN 1. DRAIN
 2. DRAIN
 3. DRAIN
 4. DRAIN
 5. GATE
 6. GATE
 7. SOURCE
 8. SOURCE</p> | <p>STYLE 6:
 PIN 1. SOURCE
 2. DRAIN
 3. DRAIN
 4. SOURCE
 5. SOURCE
 6. GATE
 7. GATE
 8. SOURCE</p> | <p>STYLE 7:
 PIN 1. INPUT
 2. EXTERNAL BYPASS
 3. THIRD STAGE SOURCE
 4. GROUND
 5. DRAIN
 6. GATE 3
 7. SECOND STAGE Vd
 8. FIRST STAGE Vd</p> | <p>STYLE 8:
 PIN 1. COLLECTOR, DIE #1
 2. BASE, #1
 3. BASE, #2
 4. COLLECTOR, #2
 5. COLLECTOR, #2
 6. EMITTER, #2
 7. EMITTER, #1
 8. COLLECTOR, #1</p> |
| <p>STYLE 9:
 PIN 1. EMITTER, COMMON
 2. COLLECTOR, DIE #1
 3. COLLECTOR, DIE #2
 4. EMITTER, COMMON
 5. EMITTER, COMMON
 6. BASE, DIE #2
 7. BASE, DIE #1
 8. EMITTER, COMMON</p> | <p>STYLE 10:
 PIN 1. GROUND
 2. BIAS 1
 3. OUTPUT
 4. GROUND
 5. GROUND
 6. BIAS 2
 7. INPUT
 8. GROUND</p> | <p>STYLE 11:
 PIN 1. SOURCE 1
 2. GATE 1
 3. SOURCE 2
 4. GATE 2
 5. DRAIN 2
 6. DRAIN 2
 7. DRAIN 1
 8. DRAIN 1</p> | <p>STYLE 12:
 PIN 1. SOURCE
 2. SOURCE
 3. SOURCE
 4. GATE
 5. DRAIN
 6. DRAIN
 7. DRAIN
 8. DRAIN</p> |
| <p>STYLE 13:
 PIN 1. N.C.
 2. SOURCE
 3. SOURCE
 4. GATE
 5. DRAIN
 6. DRAIN
 7. DRAIN
 8. DRAIN</p> | <p>STYLE 14:
 PIN 1. N-SOURCE
 2. N-GATE
 3. P-SOURCE
 4. P-GATE
 5. P-DRAIN
 6. P-DRAIN
 7. N-DRAIN
 8. N-DRAIN</p> | <p>STYLE 15:
 PIN 1. ANODE 1
 2. ANODE 1
 3. ANODE 1
 4. ANODE 1
 5. CATHODE, COMMON
 6. CATHODE, COMMON
 7. CATHODE, COMMON
 8. CATHODE, COMMON</p> | <p>STYLE 16:
 PIN 1. EMITTER, DIE #1
 2. BASE, DIE #1
 3. EMITTER, DIE #2
 4. BASE, DIE #2
 5. COLLECTOR, DIE #2
 6. COLLECTOR, DIE #2
 7. COLLECTOR, DIE #1
 8. COLLECTOR, DIE #1</p> |
| <p>STYLE 17:
 PIN 1. VCC
 2. V2OUT
 3. V1OUT
 4. TXE
 5. RXE
 6. VEE
 7. GND
 8. ACC</p> | <p>STYLE 18:
 PIN 1. ANODE
 2. ANODE
 3. SOURCE
 4. GATE
 5. DRAIN
 6. DRAIN
 7. CATHODE
 8. CATHODE</p> | <p>STYLE 19:
 PIN 1. SOURCE 1
 2. GATE 1
 3. SOURCE 2
 4. GATE 2
 5. DRAIN 2
 6. MIRROR 2
 7. DRAIN 1
 8. MIRROR 1</p> | <p>STYLE 20:
 PIN 1. SOURCE (N)
 2. GATE (N)
 3. SOURCE (P)
 4. GATE (P)
 5. DRAIN
 6. DRAIN
 7. DRAIN
 8. DRAIN</p> |
| <p>STYLE 21:
 PIN 1. CATHODE 1
 2. CATHODE 2
 3. CATHODE 3
 4. CATHODE 4
 5. CATHODE 5
 6. COMMON ANODE
 7. COMMON ANODE
 8. CATHODE 6</p> | <p>STYLE 22:
 PIN 1. I/O LINE 1
 2. COMMON CATHODE/VCC
 3. COMMON CATHODE/VCC
 4. I/O LINE 3
 5. COMMON ANODE/GND
 6. I/O LINE 4
 7. I/O LINE 5
 8. COMMON ANODE/GND</p> | <p>STYLE 23:
 PIN 1. LINE 1 IN
 2. COMMON ANODE/GND
 3. COMMON ANODE/GND
 4. LINE 2 IN
 5. LINE 2 OUT
 6. COMMON ANODE/GND
 7. COMMON ANODE/GND
 8. LINE 1 OUT</p> | <p>STYLE 24:
 PIN 1. BASE
 2. EMITTER
 3. COLLECTOR/ANODE
 4. COLLECTOR/ANODE
 5. CATHODE
 6. CATHODE
 7. COLLECTOR/ANODE
 8. COLLECTOR/ANODE</p> |
| <p>STYLE 25:
 PIN 1. VIN
 2. N/C
 3. REXT
 4. GND
 5. IOUT
 6. IOUT
 7. IOUT
 8. IOUT</p> | <p>STYLE 26:
 PIN 1. GND
 2. dv/dt
 3. ENABLE
 4. ILIMIT
 5. SOURCE
 6. SOURCE
 7. SOURCE
 8. VCC</p> | <p>STYLE 27:
 PIN 1. ILIMIT
 2. OVLO
 3. UVLO
 4. INPUT+
 5. SOURCE
 6. SOURCE
 7. SOURCE
 8. DRAIN</p> | <p>STYLE 28:
 PIN 1. SW_TO_GND
 2. DASIC OFF
 3. DASIC_SW_DET
 4. GND
 5. V_MON
 6. VBULK
 7. VBULK
 8. VIN</p> |
| <p>STYLE 29:
 PIN 1. BASE, DIE #1
 2. EMITTER, #1
 3. BASE, #2
 4. EMITTER, #2
 5. COLLECTOR, #2
 6. COLLECTOR, #2
 7. COLLECTOR, #1
 8. COLLECTOR, #1</p> | <p>STYLE 30:
 PIN 1. DRAIN 1
 2. DRAIN 1
 3. GATE 2
 4. SOURCE 2
 5. SOURCE 1/DRAIN 2
 6. SOURCE 1/DRAIN 2
 7. SOURCE 1/DRAIN 2
 8. GATE 1</p> | | |

DOCUMENT NUMBER:	98ASB42564B	Electronic versions are uncontrolled except when accessed directly from the Document Repository. Printed versions are uncontrolled except when stamped "CONTROLLED COPY" in red.
DESCRIPTION:	SOIC-8 NB	PAGE 2 OF 2

onsemi and **ONSEMI** are trademarks of Semiconductor Components Industries, LLC dba **onsemi** or its subsidiaries in the United States and/or other countries. **onsemi** reserves the right to make changes without further notice to any products herein. **onsemi** makes no warranty, representation or guarantee regarding the suitability of its products for any particular purpose, nor does **onsemi** assume any liability arising out of the application or use of any product or circuit, and specifically disclaims any and all liability, including without limitation special, consequential or incidental damages. **onsemi** does not convey any license under its patent rights nor the rights of others.

onsemi, **Onsemi**, and other names, marks, and brands are registered and/or common law trademarks of Semiconductor Components Industries, LLC dba "**onsemi**" or its affiliates and/or subsidiaries in the United States and/or other countries. **onsemi** owns the rights to a number of patents, trademarks, copyrights, trade secrets, and other intellectual property. A listing of **onsemi**'s product/patent coverage may be accessed at www.onsemi.com/site/pdf/Patent-Marking.pdf. **onsemi** reserves the right to make changes at any time to any products or information herein, without notice. The information herein is provided "as-is" and **onsemi** makes no warranty, representation or guarantee regarding the accuracy of the information, product features, availability, functionality, or suitability of its products for any particular purpose, nor does **onsemi** assume any liability arising out of the application or use of any product or circuit, and specifically disclaims any and all liability, including without limitation special, consequential or incidental damages. Buyer is responsible for its products and applications using **onsemi** products, including compliance with all laws, regulations and safety requirements or standards, regardless of any support or applications information provided by **onsemi**. "Typical" parameters which may be provided in **onsemi** data sheets and/or specifications can and do vary in different applications and actual performance may vary over time. All operating parameters, including "Typicals" must be validated for each customer application by customer's technical experts. **onsemi** does not convey any license under any of its intellectual property rights nor the rights of others. **onsemi** products are not designed, intended, or authorized for use as a critical component in life support systems or any FDA Class 3 medical devices or medical devices with a same or similar classification in a foreign jurisdiction or any devices intended for implantation in the human body. Should Buyer purchase or use **onsemi** products for any such unintended or unauthorized application, Buyer shall indemnify and hold **onsemi** and its officers, employees, subsidiaries, affiliates, and distributors harmless against all claims, costs, damages, and expenses, and reasonable attorney fees arising out of, directly or indirectly, any claim of personal injury or death associated with such unintended or unauthorized use, even if such claim alleges that **onsemi** was negligent regarding the design or manufacture of the part. **onsemi** is an Equal Opportunity/Affirmative Action Employer. This literature is subject to all applicable copyright laws and is not for resale in any manner.

ADDITIONAL INFORMATION

TECHNICAL PUBLICATIONS:

Technical Library: www.onsemi.com/design/resources/technical-documentation
onsemi Website: www.onsemi.com

ONLINE SUPPORT: www.onsemi.com/support

For additional information, please contact your local Sales Representative at www.onsemi.com/support/sales