

## TPS706 150-mA, 6.5-V, 1- $\mu$ A $I_Q$ Voltage Regulators with Enable

### 1 Features

- Input Voltage Range: 2.7 V to 6.5 V
- Ultralow  $I_Q$ : 1  $\mu$ A
- Reverse Current Protection
- Low  $I_{SHDN}$ : 150 nA
- Supports 200-mA Peak Output
- Low Dropout: 245 mV at 50 mA
- 2% Accuracy Over Temperature
- Available in Fixed-Output Voltages: 1.2 V to 5 V
- Thermal Shutdown and Overcurrent Protection
- Packages: SOT-23-5, WSON-6

### 2 Applications

- Smartphones and Tablets
- Portable and Battery-Powered Applications
- Camera Modules
- Set-Top Boxes
- Wearables
- Solid State Drives
- Medical Equipment

### 3 Description

The TPS706 series of linear voltage regulators are ultralow, quiescent current devices designed for power-sensitive applications. A precision band-gap and error amplifier provides 2% accuracy over temperature. Quiescent current of only 1  $\mu$ A makes these devices ideal solutions for battery-powered, always-on systems that require very little idle-state power dissipation. These devices have thermal-shutdown, current-limit, and reverse-current protection for added safety.

These regulators can be put into shutdown mode by pulling the EN pin low. The shutdown current in this mode goes down to 150 nA, typical.

The TPS706 series is available in WSON-6 and SOT-23-5 packages.

#### Device Information<sup>(1)</sup>

PART NUMBER	PACKAGE	BODY SIZE (NOM)
TPS706	SOT-23 (5)	2.90 mm x 1.60 mm
	WSON (6)	2.00 mm x 2.00 mm

(1) For all available packages, see the orderable addendum at the end of the datasheet.

#### Typical Application Circuit

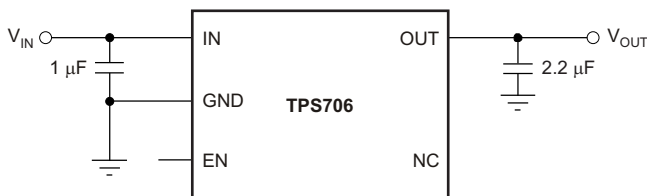

#### GND Current vs $V_{IN}$ and Temperature

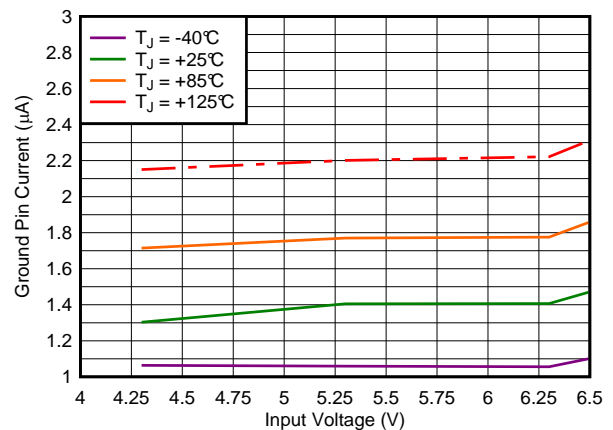

## Table of Contents

<b>1 Features</b> .....	1	7.3 Feature Description.....	11
<b>2 Applications</b> .....	1	7.4 Device Functional Modes.....	13
<b>3 Description</b> .....	1	<b>8 Application and Implementation</b> .....	14
<b>4 Revision History</b> .....	2	8.1 Application Information.....	14
<b>5 Pin Configuration and Functions</b> .....	3	8.2 Typical Application .....	15
<b>6 Specifications</b> .....	4	<b>9 Power Supply Recommendations</b> .....	15
6.1 Absolute Maximum Ratings .....	4	<b>10 Layout</b> .....	16
6.2 ESD Ratings.....	4	10.1 Layout Guidelines .....	16
6.3 Recommended Operating Conditions.....	4	10.2 Layout Examples.....	18
6.4 Thermal Information .....	4	<b>11 Device and Documentation Support</b> .....	19
6.5 Electrical Characteristics.....	5	11.1 Device Support.....	19
6.6 Timing Requirements .....	5	11.2 Documentation Support .....	19
6.7 Typical Characteristics .....	6	11.3 Trademarks .....	19
<b>7 Detailed Description</b> .....	11	11.4 Electrostatic Discharge Caution.....	19
7.1 Overview .....	11	11.5 Glossary .....	19
7.2 Functional Block Diagram .....	11	<b>12 Mechanical, Packaging, and Orderable Information</b> .....	19

## 4 Revision History

### Changes from Original (October 2014) to Revision A

Page

- |  |   |
|--|---|
| • Made changes to product preview data sheet; released as Production Data..... | 1 |
|--|---|

## 5 Pin Configuration and Functions

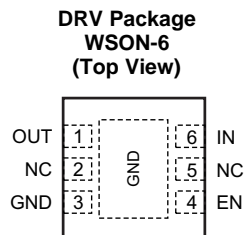
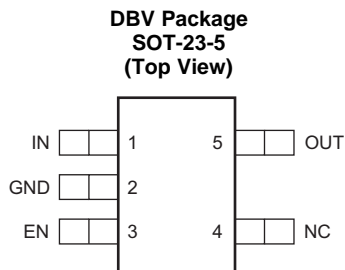

### Pin Functions

NAME	PIN NO.		I/O	DESCRIPTION
	DRV	DBV		
EN	4	3	I	Enable pin. Driving this pin high enables the device. Driving this pin low puts the device into low current shutdown. This pin can be left floating to enable the device. The maximum voltage must remain below 6.5 V.
GND	3	2	—	Ground
IN	6	1	I	Unregulated input to the device
NC	2, 5	4	—	No internal connection
OUT	1	5	O	Regulated output voltage. Connect a small 2.2- $\mu$ F or greater ceramic capacitor from this pin to ground to assure stability.
Thermal pad	—	—	—	The thermal pad is electrically connected to the GND node. Connect to the GND plane for improved thermal performance.

## 6 Specifications

### 6.1 Absolute Maximum Ratings

specified at  $T_J = -40^\circ\text{C}$  to  $125^\circ\text{C}$ , unless otherwise noted; all voltages are with respect to GND<sup>(1)</sup>

		MIN	MAX	UNIT
Voltage	$V_{IN}$	-0.3	7	V
	$V_{EN}$	-0.3	7	V
	$V_{OUT}$	-0.3	7	V
Maximum output current	$I_{OUT}$	Internally limited		
Output short-circuit duration		Indefinite		
Continuous total power dissipation	$P_{DISS}$	See <a href="#">Thermal Information</a>		
Junction temperature, $T_J$		-55	150	$^\circ\text{C}$
Storage temperature, $T_{stg}$		-55	150	$^\circ\text{C}$

- (1) Stresses beyond those listed under *Absolute Maximum Ratings* may cause permanent damage to the device. These are stress ratings only, which do not imply functional operation of the device at these or any other conditions beyond those indicated under *Recommended Operating Conditions*. Exposure to absolute-maximum-rated conditions for extended periods may affect device reliability.

### 6.2 ESD Ratings

		VALUE	UNIT
$V_{(ESD)}$ Electrostatic discharge	Human body model (HBM), per ANSI/ESDA/JEDEC JS-001 <sup>(1)</sup>	$\pm 2000$	V
	Charged device model (CDM), per JEDEC specification JESD22-C101 <sup>(2)</sup>	$\pm 500$	

- (1) JEDEC document JEP155 states that 2-kV HBM allows safe manufacturing with a standard ESD control process.  
 (2) JEDEC document JEP157 states that 500-V CDM allows safe manufacturing with a standard ESD control process.

### 6.3 Recommended Operating Conditions

over operating junction temperature range (unless otherwise noted)

		MIN	NOM	MAX	UNIT
$V_{IN}$	Input voltage	2.7		6.5	V
$V_{OUT}$	Output voltage	1.2		5	V
$I_{OUT}$	Output current	0		150	mA
$V_{EN}$	Enable voltage	0		6.5	V
$C_{IN}$	Input capacitor	0	1		$\mu\text{F}$
$C_{OUT}$	Output capacitor	2	2.2	47	$\mu\text{F}$
$T_J$	Operating junction temperature	-40		125	$^\circ\text{C}$

### 6.4 Thermal Information

THERMAL METRIC <sup>(1)</sup>		TPS706		UNIT
		DBV	DRV	
		5 PINS	6 PINS	
$R_{\theta JA}$	Junction-to-ambient thermal resistance	212.1	73.1	$^\circ\text{C}/\text{W}$
$R_{\theta JC(top)}$	Junction-to-case (top) thermal resistance	78.5	97.0	
$R_{\theta JB}$	Junction-to-board thermal resistance	39.5	42.6	
$\psi_{JT}$	Junction-to-top characterization parameter	2.86	2.9	
$\psi_{JB}$	Junction-to-board characterization parameter	38.7	42.9	
$R_{\theta JC(bot)}$	Junction-to-case (bottom) thermal resistance	N/A	12.8	

- (1) For more information about traditional and new thermal metrics, see the *IC Package Thermal Metrics* application report, [SPRA953](#).

## 6.5 Electrical Characteristics

At  $T_J = -40^\circ\text{C}$  to  $125^\circ\text{C}$ ,  $V_{IN} = V_{OUT(nom)} + 1\text{ V}$  or  $2.7\text{ V}$  (whichever is greater),  $I_{OUT} = 1\text{ mA}$ ,  $V_{EN} = 2\text{ V}$ , and  $C_{IN} = C_{OUT} = 2.2\text{-}\mu\text{F}$  ceramic, unless otherwise noted. Typical values are at  $T_J = 25^\circ\text{C}$ .

PARAMETER		TEST CONDITIONS	MIN	TYP	MAX	UNIT
$V_{IN}$	Input voltage range		2.7		6.5	V
$V_{OUT}$	Output voltage range		1.2		5.0	V
$V_{OUT(accuracy)}$	DC output accuracy	$V_{OUT} < 3.3\text{ V}$	-2%		2%	
		$V_{OUT} \geq 3.3\text{ V}$ , $T_J = -40^\circ\text{C}$ to $85^\circ\text{C}$	-1%		1%	
$\Delta V_{OUT}$	Line regulation	$(V_{OUT(nom)} + 1\text{ V}, 2.7\text{ V}) \leq V_{IN} \leq 6.5\text{ V}$		3	10	mV
	Load regulation	$V_{IN} = V_{OUT(nom)} + 1.5\text{ V}$ or $3\text{ V}$ (whichever is greater), $100\text{ }\mu\text{A} \leq I_{OUT} \leq 150\text{ mA}$		20	50	mV
$V_{DO}$	Dropout voltage <sup>(1)(2)</sup>	$2.8\text{ V} \leq V_{OUT} \leq 3.3\text{ V}$ , $I_{OUT} = 50\text{ mA}$		295	650	mV
		$2.8\text{ V} \leq V_{OUT} \leq 3.3\text{ V}$ , $I_{OUT} = 150\text{ mA}$		975	1540	mV
$I_{(CL)}$	Output current limit <sup>(3)</sup>	$V_{OUT} = 0.9 \times V_{OUT(nom)}$	200	320	500	mA
$I_{GND}$	Ground pin current	$I_{OUT} = 0\text{ mA}$ , $V_{OUT} \leq 3.3\text{ V}$		1.3	2.55	$\mu\text{A}$
		$I_{OUT} = 150\text{ mA}$		350		$\mu\text{A}$
$I_{SHDN}$	Shutdown current	$V_{EN} \leq 0.4\text{ V}$ , $V_{IN} = 2.7\text{ V}$		150		nA
PSRR	Power-supply rejection ratio	$f = 10\text{ Hz}$		80		dB
		$f = 100\text{ Hz}$		62		dB
		$f = 1\text{ kHz}$		52		dB
$V_n$	Output noise voltage	$BW = 10\text{ Hz}$ to $100\text{ kHz}$ , $I_{OUT} = 10\text{ mA}$ , $V_{IN} = 2.7\text{ V}$ , $V_{OUT} = 1.2\text{ V}$		190		$\mu\text{V}_{RMS}$
$V_{EN(HI)}$	Enable pin high (enabled)		0.9			V
	Enable pin high (disabled)		0		0.4	V
$I_{EN}$	EN pin current	$EN = 1.0\text{ V}$ , $V_{IN} = 5.5\text{ V}$		300		nA
$I_{REV}$	Reverse current (flowing out of IN pin)	$V_{OUT} = 3\text{ V}$ , $V_{IN} = V_{EN} = 0\text{ V}$		10		nA
	Reverse current (flowing into OUT pin)	$V_{OUT} = 3\text{ V}$ , $V_{IN} = V_{EN} = 0\text{ V}$		100		nA
$T_{SD}$	Thermal shutdown temperature	Shutdown, temperature increasing		158		$^\circ\text{C}$
		Reset, temperature decreasing		140		$^\circ\text{C}$
$T_J$	Operating junction temperature		-40		125	$^\circ\text{C}$

(1)  $V_{DO}$  is measured with  $V_{IN} = 0.98 \times V_{OUT(nom)}$ .

(2) Dropout is only valid when  $V_{OUT} \geq 2.8\text{ V}$  because of the minimum input voltage limits.

(3) Measured with  $V_{IN} = V_{OUT} + 3\text{ V}$  for  $V_{OUT} \leq 2.5\text{ V}$ . Measured with  $V_{IN} = V_{OUT} + 2.5\text{ V}$  for  $V_{OUT} > 2.5\text{ V}$ .

## 6.6 Timing Requirements

At  $T_J = -40^\circ\text{C}$  to  $125^\circ\text{C}$ ,  $V_{IN} = V_{OUT(nom)} + 1\text{ V}$  or  $2.7\text{ V}$  (whichever is greater),  $R_L = 47\text{ }\Omega$ ,  $V_{EN} = 2\text{ V}$ , and  $C_{IN} = C_{OUT} = 2.2\text{-}\mu\text{F}$  ceramic, unless otherwise noted. Typical values are at  $T_J = 25^\circ\text{C}$ .

PARAMETER		MIN	TYP	MAX	UNIT
$t_{STR}$	Start-up time <sup>(1)</sup>	$V_{OUT(nom)} \leq 3.3\text{ V}$	200	600	$\mu\text{s}$
		$V_{OUT} > 3.3\text{ V}$	500	1500	$\mu\text{s}$

(1) Startup time = time from EN assertion to  $0.95 \times V_{OUT(nom)}$  and load =  $47\text{ }\Omega$ .

### 6.7 Typical Characteristics

Over operating temperature range ( $T_J = -40^\circ\text{C}$  to  $125^\circ\text{C}$ ),  $I_{OUT} = 10\text{ mA}$ ,  $V_{EN} = 2\text{ V}$ ,  $C_{OUT} = 2.2\text{ }\mu\text{F}$ , and  $V_{IN} = V_{OUT(nom)} + 1\text{ V}$  or  $2.7\text{ V}$  (whichever is greater), unless otherwise noted. Typical values are at  $T_J = 25^\circ\text{C}$ .

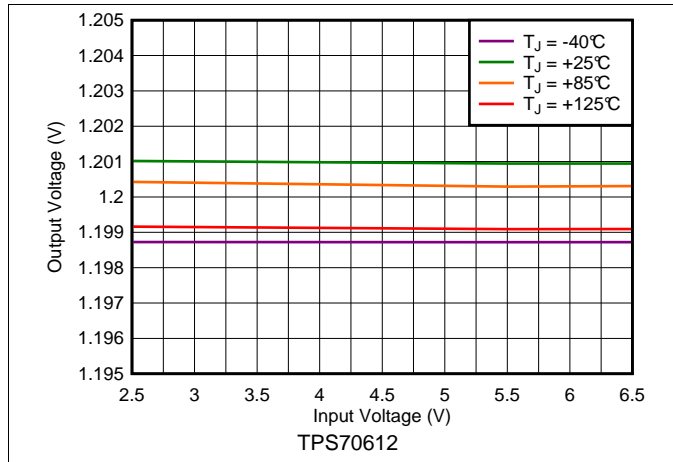

Figure 1. 1.2-V Line Regulation vs  $V_{IN}$  and Temperature

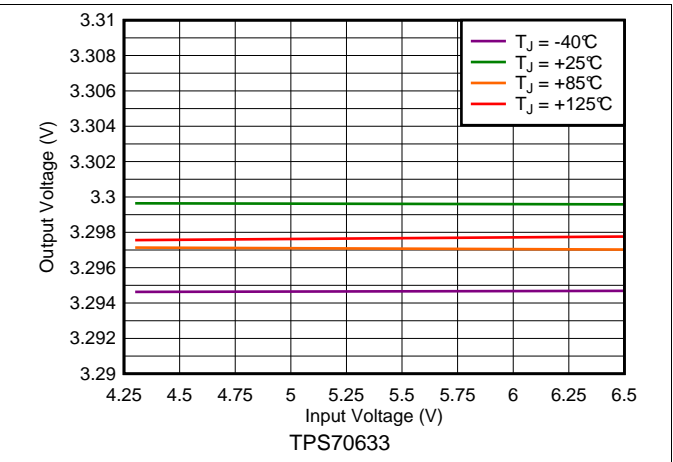

Figure 2. 3.3-V Line Regulation vs  $V_{IN}$  and Temperature

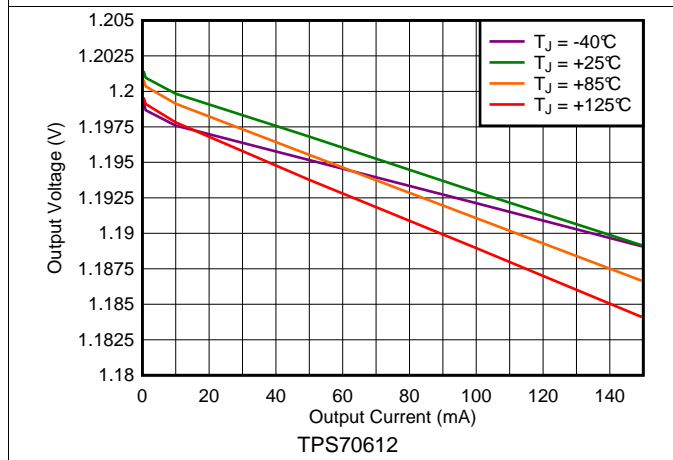

Figure 3. 1.2-V Load Regulation vs  $I_{OUT}$  and Temperature

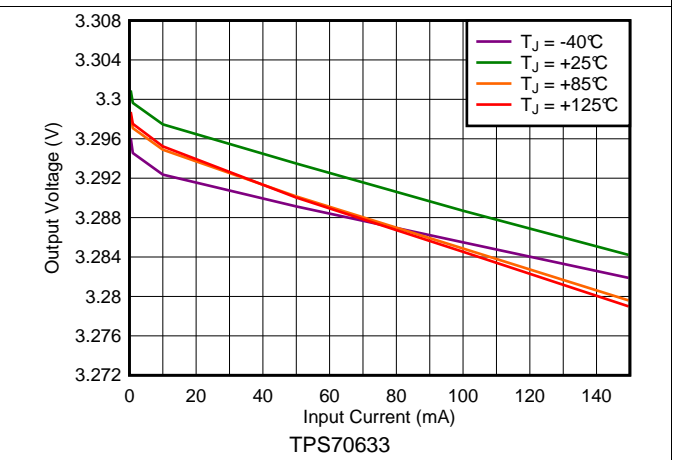

Figure 4. 3.3-V Load Regulation vs  $I_{OUT}$  and Temperature

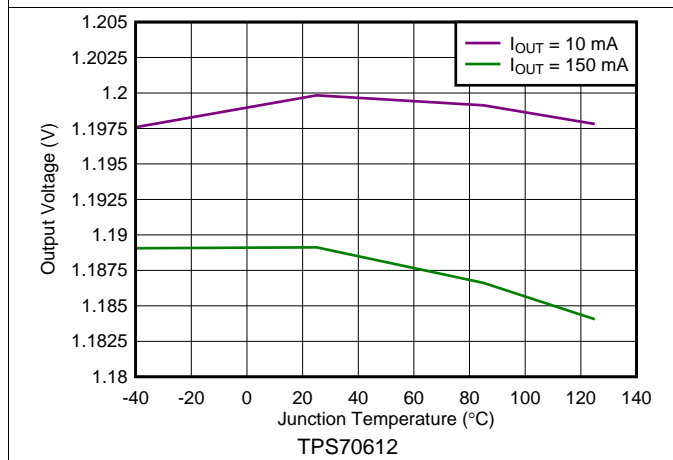

Figure 5.  $V_{OUT}$  vs Temperature

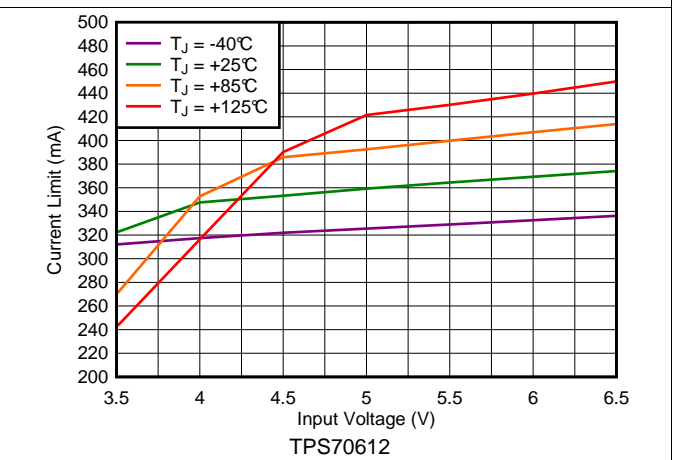

Figure 6. 1.2-V Current Limit vs  $V_{IN}$  and Temperature

Typical Characteristics (continued)

Over operating temperature range ( $T_J = -40^{\circ}\text{C}$  to  $125^{\circ}\text{C}$ ),  $I_{OUT} = 10\text{ mA}$ ,  $V_{EN} = 2\text{ V}$ ,  $C_{OUT} = 2.2\text{ }\mu\text{F}$ , and  $V_{IN} = V_{OUT(nom)} + 1\text{ V}$  or  $2.7\text{ V}$  (whichever is greater), unless otherwise noted. Typical values are at  $T_J = 25^{\circ}\text{C}$ .

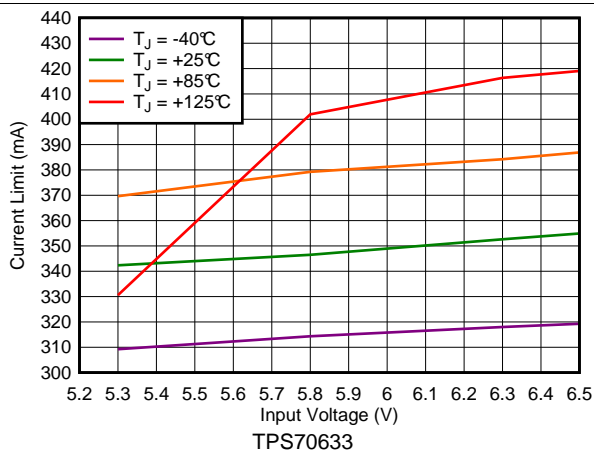

Figure 7. 3.3-V Current Limit vs  $V_{IN}$  and Temperature

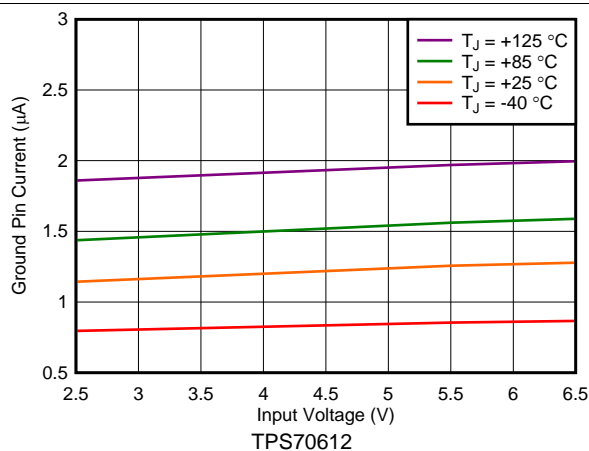

Figure 8. GND Current vs  $V_{IN}$  and Temperature

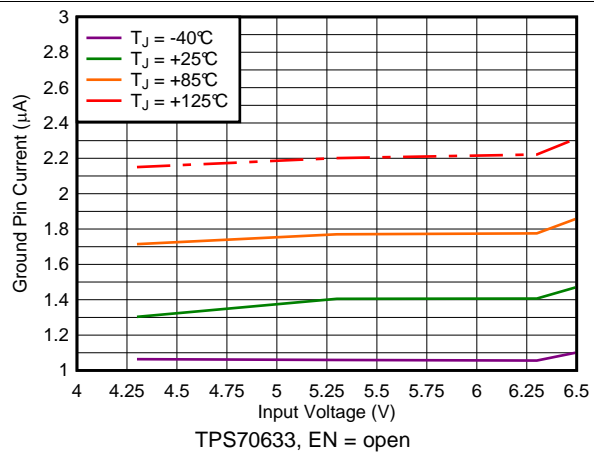

Figure 9. GND Current vs  $V_{IN}$  and Temperature

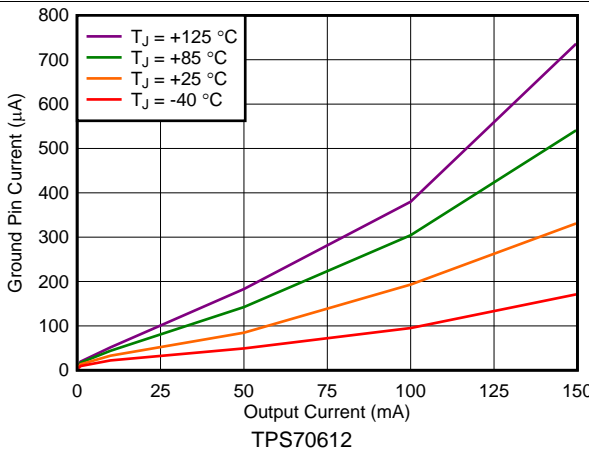

Figure 10. GND Current vs  $I_{OUT}$  and Temperature

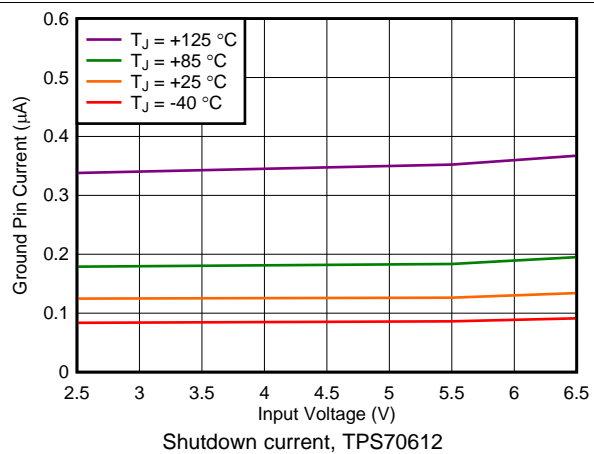

Figure 11. Shutdown Current vs  $V_{IN}$  and Temperature

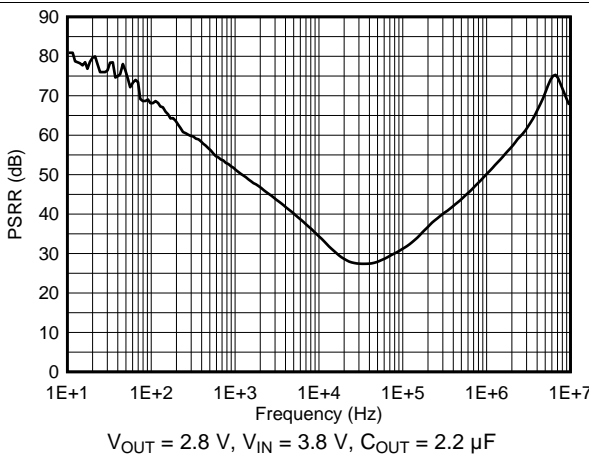

Figure 12. Power-Supply Rejection Ratio vs Frequency

### Typical Characteristics (continued)

Over operating temperature range ( $T_J = -40^{\circ}\text{C}$  to  $125^{\circ}\text{C}$ ),  $I_{OUT} = 10\text{ mA}$ ,  $V_{EN} = 2\text{ V}$ ,  $C_{OUT} = 2.2\text{ }\mu\text{F}$ , and  $V_{IN} = V_{OUT(nom)} + 1\text{ V}$  or  $2.7\text{ V}$  (whichever is greater), unless otherwise noted. Typical values are at  $T_J = 25^{\circ}\text{C}$ .

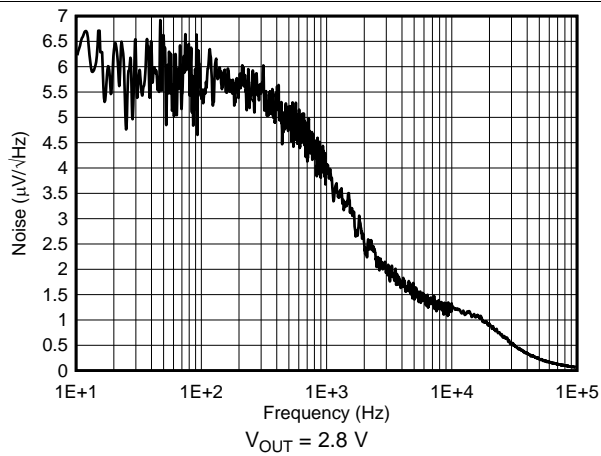

Figure 13. Noise

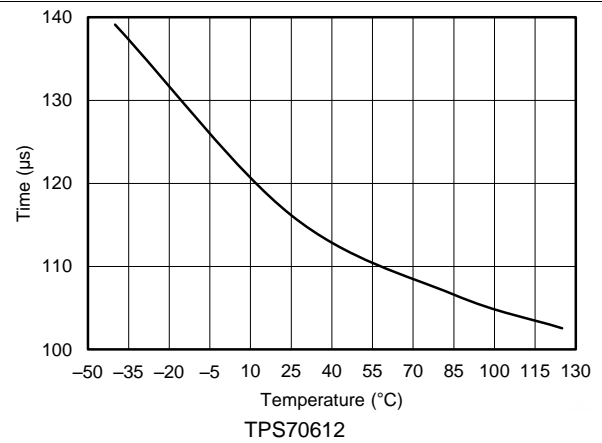
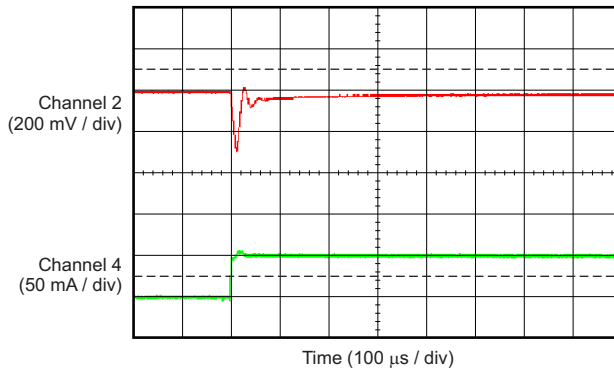
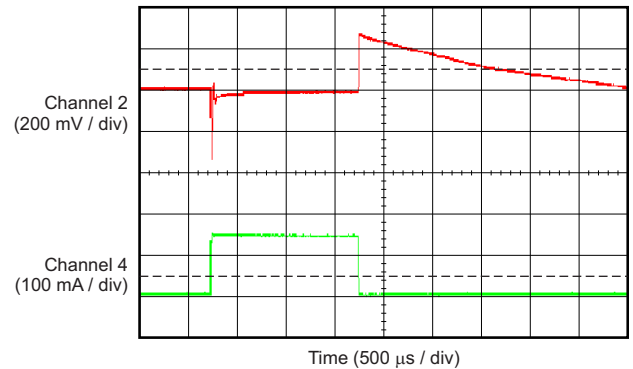

Figure 14. Start-Up Time vs Temperature



Channel 2 =  $V_{OUT}$ , channel 4 =  $I_{OUT}$ ,  $V_{IN} = 2.7\text{ V}$

Figure 15. TPS70612 Load Transient (0 mA to 50 mA)



Channel 2 =  $V_{OUT}$ , channel 4 =  $I_{OUT}$ ,  $V_{IN} = 2.7\text{ V}$

Figure 16. TPS70612 Load Transient (1 mA to 150 mA)

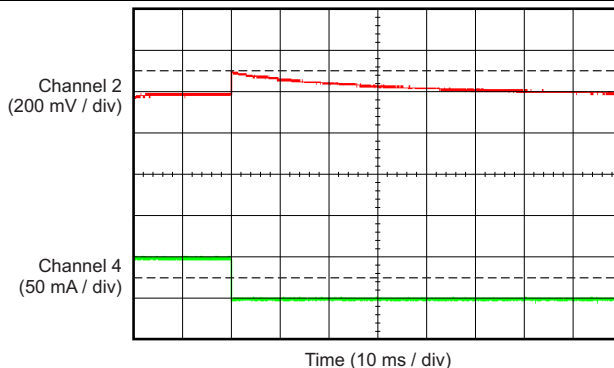

Channel 2 =  $V_{OUT}$ , channel 4 =  $I_{OUT}$ ,  $V_{IN} = 2.7\text{ V}$

Figure 17. TPS70612 Load Transient (50 mA to 0 mA)

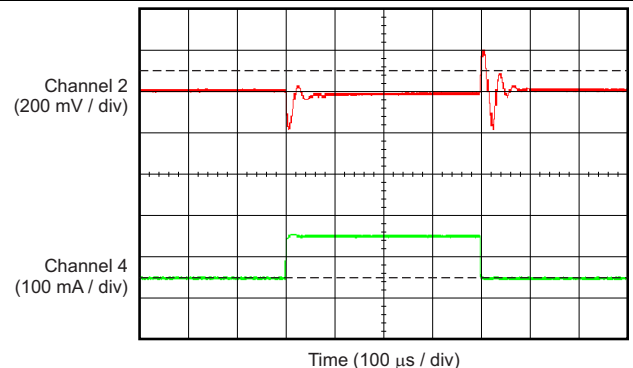

Channel 2 =  $V_{OUT}$ , channel 4 =  $I_{OUT}$ ,  $V_{IN} = 2.7\text{ V}$

Figure 18. TPS70612 Load Transient (50 mA to 150 mA)



### Typical Characteristics (continued)

Over operating temperature range ( $T_J = -40^{\circ}\text{C}$  to  $125^{\circ}\text{C}$ ),  $I_{OUT} = 10\text{ mA}$ ,  $V_{EN} = 2\text{ V}$ ,  $C_{OUT} = 2.2\text{ }\mu\text{F}$ , and  $V_{IN} = V_{OUT(nom)} + 1\text{ V}$  or  $2.7\text{ V}$  (whichever is greater), unless otherwise noted. Typical values are at  $T_J = 25^{\circ}\text{C}$ .

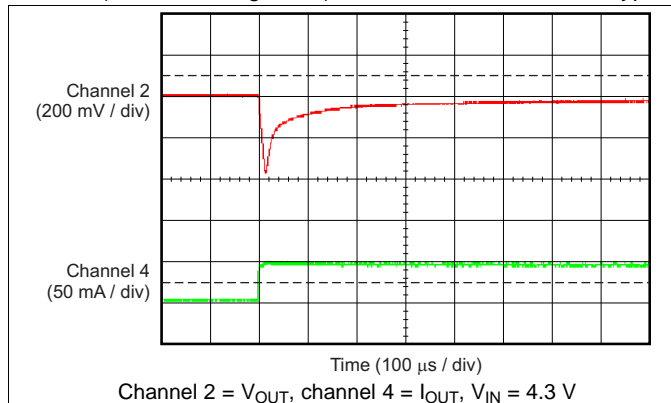

Figure 19. TPS70633 Load Transient (0 mA to 50 mA)

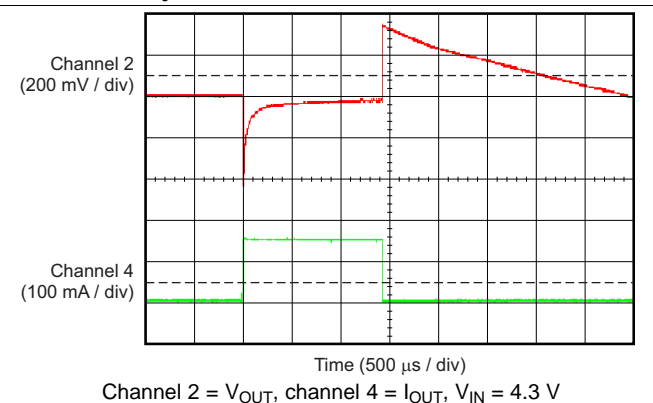

Figure 20. TPS70633 Load Transient (1 mA to 150 mA)

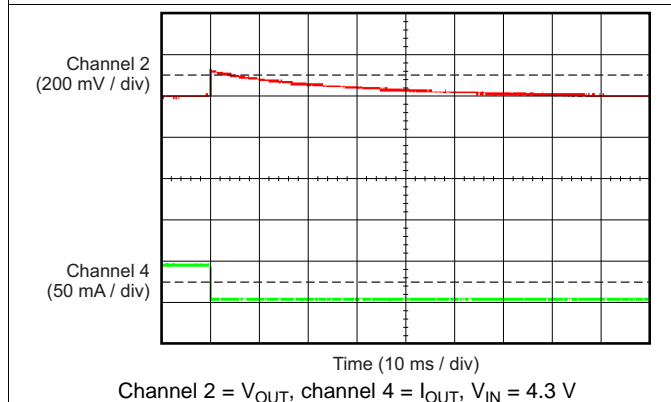

Figure 21. TPS70633 Load Transient (50 mA to 0 mA)

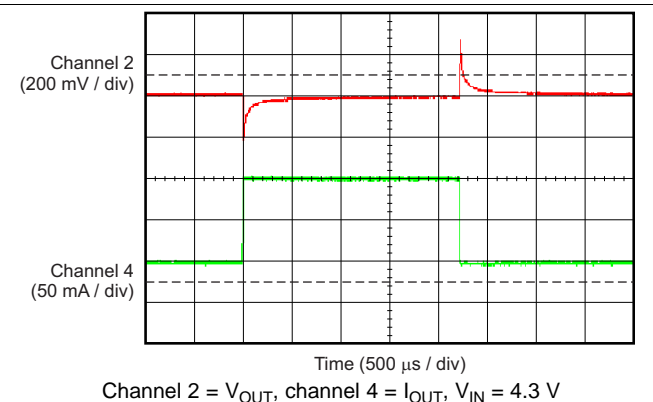

Figure 22. TPS70633 Load Transient (50 mA to 150 mA)

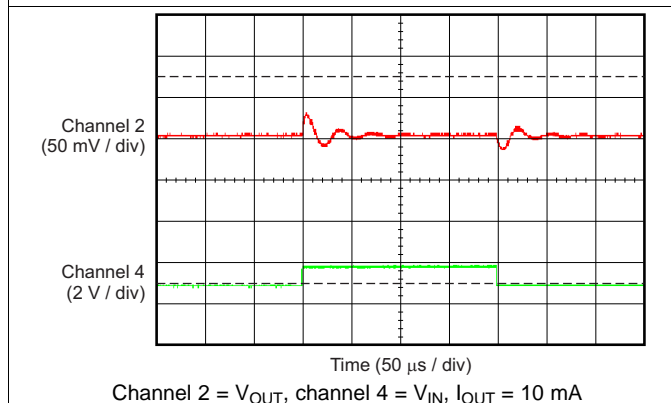

Figure 23. TPS70612 Line Transient (2.7 V to 3.7 V)

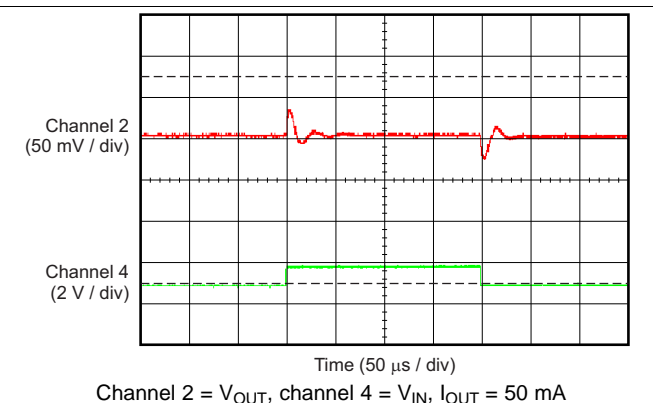
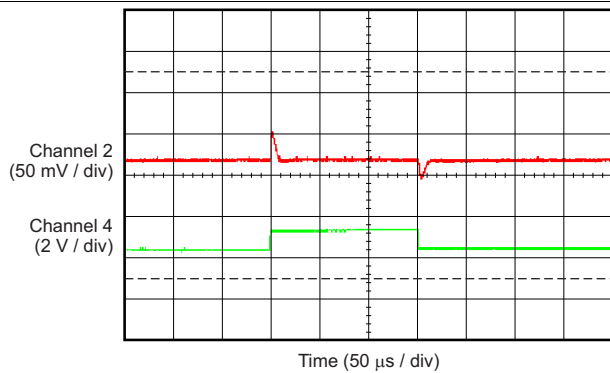

Figure 24. TPS70612 Line Transient (2.7 V to 3.7 V)

**Typical Characteristics (continued)**

Over operating temperature range ( $T_J = -40^{\circ}\text{C}$  to  $125^{\circ}\text{C}$ ),  $I_{OUT} = 10\text{ mA}$ ,  $V_{EN} = 2\text{ V}$ ,  $C_{OUT} = 2.2\text{ }\mu\text{F}$ , and  $V_{IN} = V_{OUT(nom)} + 1\text{ V}$  or  $2.7\text{ V}$  (whichever is greater), unless otherwise noted. Typical values are at  $T_J = 25^{\circ}\text{C}$ .



Channel 2 =  $V_{OUT}$ , channel 4 =  $V_{IN}$ ,  $I_{OUT} = 10\text{ mA}$

**Figure 25. TPS70633 Line Transient (4.3 V to 5.3 V)**

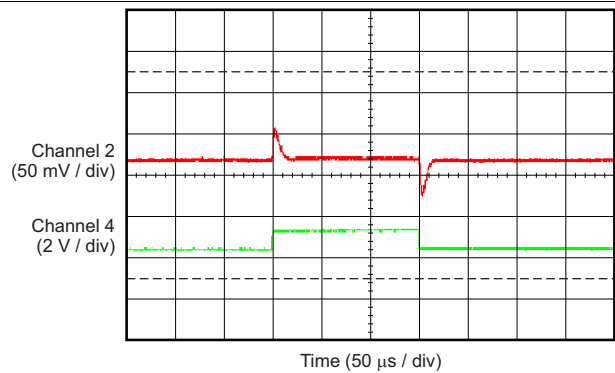

Channel 2 =  $V_{OUT}$ , channel 4 =  $V_{IN}$ ,  $I_{OUT} = 50\text{ mA}$

**Figure 26. TPS70633 Line Transient (4.3 V to 5.3 V)**

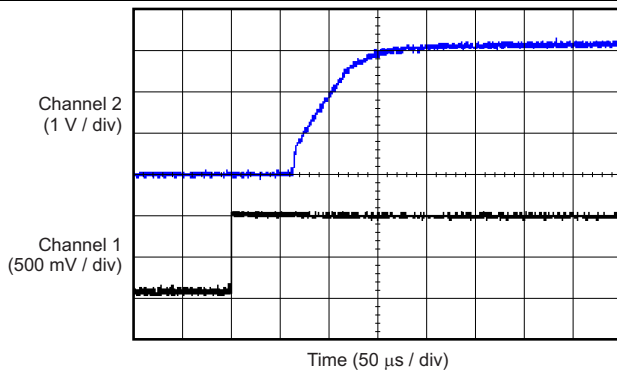

Channel 1 = EN, channel 2 =  $V_{OUT}$ ,  $V_{IN} = 4.3\text{ V}$ ,  $C_{OUT} = 2.2\text{ }\mu\text{F}$ , TPS70633

**Figure 27. Power-Up with Enable**

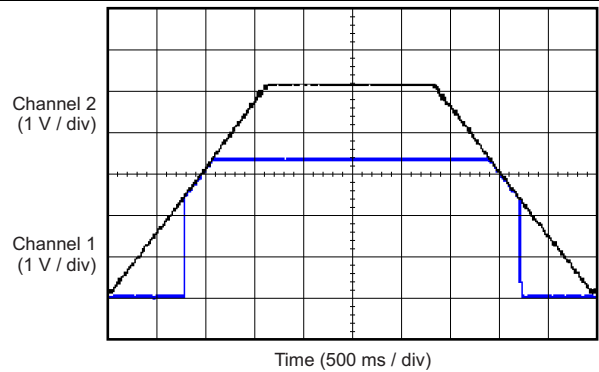

Channel 1 =  $V_{IN}$ , channel 2 =  $V_{OUT}$ ,  $I_{OUT} = 3\text{ mA}$ , TPS70633

**Figure 28. Power-Up and Power-Down Response**

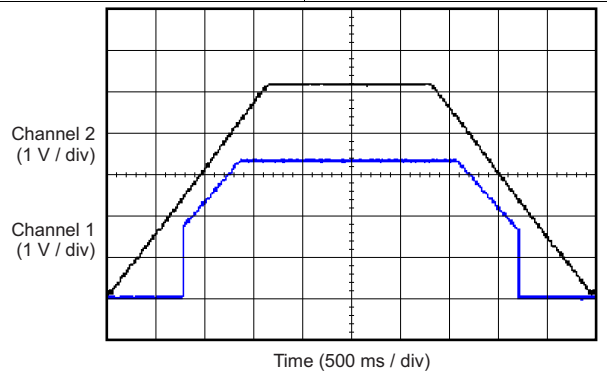

Channel 1 =  $V_{IN}$ , channel 2 =  $V_{OUT}$ ,  $I_{OUT} = 150\text{ mA}$ , TPS70633

**Figure 29. Power-Up and Power-Down Response**

## 7 Detailed Description

### 7.1 Overview

The TPS706 series are ultralow quiescent current, low-dropout (LDO) linear regulators. The TPS706 offers reverse current protection to block any discharge current from the output into the input. The TPS706 also features current limit and thermal shutdown for reliable operation.

### 7.2 Functional Block Diagram

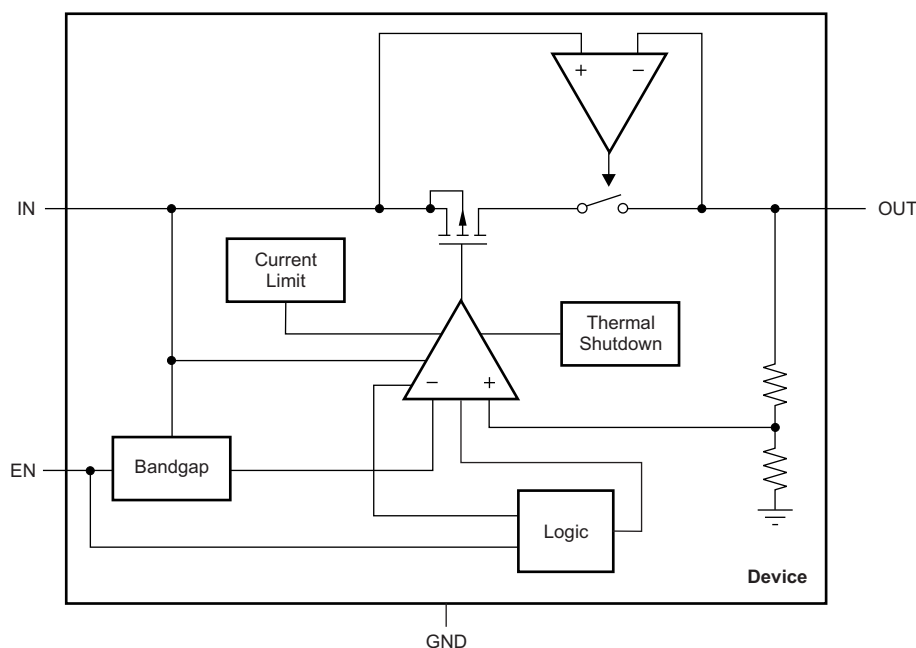

### 7.3 Feature Description

#### 7.3.1 Undervoltage Lockout (UVLO)

The TPS706 uses an undervoltage lockout (UVLO) circuit to keep the output shut off until the internal circuitry operates properly.

#### 7.3.2 Shutdown

The enable pin (EN) is active high. Enable the device by forcing the EN pin to exceed  $V_{EN(HI)}$  (0.9 V, minimum). Turn off the device by forcing the EN pin to drop below 0.4 V. If shutdown capability is not required, connect EN to IN.

#### 7.3.3 Reverse Current Protection

The TPS706 has integrated reverse current protection. Reverse current protection prevents the flow of current from the OUT pin to the IN pin when output voltage is higher than input voltage. The reverse current protection circuitry places the power path in high impedance when the output voltage is higher than the input voltage. This setting reduces leakage current from the output to the input to 10 nA, typical. The reverse current protection is always active regardless of the enable pin logic state or if the OUT pin voltage is greater than 1.8 V. Reverse current can flow if the output voltage is less than 1.8 V and if input voltage is less than the output voltage.

If voltage is applied to the input pin, then the maximum voltage that can be applied to the OUT pin is the lower of three times the nominal output voltage or 6.5 V. For example, if the 1.2-V output voltage version is used, then the maximum reverse bias voltage that can be applied to the OUT pin is 3.6 V. If the 3.3-V output voltage version is used, then the maximum reverse bias voltage that can be applied to the OUT pin is 6.5 V.

## Feature Description (continued)

### 7.3.4 Internal Current Limit

The TPS706 internal current limit helps protect the regulator during fault conditions. During current limit, the output sources a fixed amount of current that is largely independent of output voltage. In such a case, the output voltage is not regulated, and can be measured as ( $V_{OUT} = I_{LIMIT} \times R_{LOAD}$ ). The PMOS pass transistor dissipates  $[(V_{IN} - V_{OUT}) \times I_{LIMIT}]$  until a thermal shutdown is triggered and the device turns off. When cool, the device is turned on by the internal thermal shutdown circuit. If the fault condition continues, the device cycles between current limit and thermal shutdown; see the [Thermal Information](#) section for more details.

The TPS706 is characterized over the recommended operating output current range up to 150 mA. The internal current limit begins to limit the output current at a minimum of 200 mA of output current.

### 7.3.5 Thermal Protection

Thermal protection disables the output when the junction temperature rises to approximately 158°C, allowing the device to cool. When the junction temperature cools to approximately 140°C, the output circuitry is again enabled. Depending on power dissipation, thermal resistance, and ambient temperature, the thermal protection circuit can cycle on and off. This cycling limits the dissipation of the regulator, protecting it from damage as a result of overheating.

Any tendency to activate the thermal protection circuit indicates excessive power dissipation or an inadequate heatsink. For reliable operation, limit junction temperature to 125°C, maximum. To estimate the margin of safety in a complete design (including heatsink), increase the ambient temperature until the thermal protection is triggered; use worst-case loads and signal conditions. For good reliability, thermal protection must trigger at least 35°C above the maximum expected ambient condition of the particular application. This configuration produces a worst-case junction temperature of 125°C at the highest expected ambient temperature and worst-case load.

The TPS706 internal protection circuitry is designed to protect against overload conditions. This circuitry is not intended to replace proper heatsinking. Continuously running the TPS706 into thermal shutdown degrades device reliability.

## 7.4 Device Functional Modes

### 7.4.1 Normal Operation

The device regulates to the nominal output voltage under the following conditions:

- The input voltage is at least as high as  $V_{IN(min)}$ .
- The input voltage is greater than the nominal output voltage added to the dropout voltage.
- The enable voltage has previously exceeded the enable rising threshold voltage and has not decreased below the enable falling threshold.
- The output current is less than the current limit.
- The device junction temperature is less than the maximum specified junction temperature.

### 7.4.2 Dropout Operation

If the input voltage is lower than the nominal output voltage plus the specified dropout voltage, but all other conditions are met for normal operation, the device operates in dropout mode. In this mode of operation, the output voltage is the same as the input voltage minus the dropout voltage. The transient performance of the device is significantly degraded because the pass device is in the linear region and no longer controls the current through the LDO. Line or load transients in dropout can result in large output voltage deviations.

### 7.4.3 Disabled

The device is disabled under the following conditions:

- The enable voltage is less than the enable falling threshold voltage or has not yet exceeded the enable rising threshold.
- The device junction temperature is greater than the thermal shutdown temperature.

[Table 1](#) shows the conditions that lead to the different modes of operation.

**Table 1. Device Functional Mode Comparison**

OPERATING MODE	PARAMETER			
	$V_{IN}$	$V_{EN}$	$I_{OUT}$	$T_J$
Normal mode	$V_{IN} > V_{OUT(nom)} + V_{DO}$ and $V_{IN} > V_{IN(min)}$	$V_{EN} > V_{EN(HI)}$	$I_{OUT} < I_{LIM}$	$T_J < 125^{\circ}\text{C}$
Dropout mode	$V_{IN(min)} < V_{IN} < V_{OUT(nom)} + V_{DO}$	$V_{EN} > V_{EN(HI)}$	—	$T_J < 125^{\circ}\text{C}$
Disabled mode (any true condition disables the device)	—	$V_{EN} < V_{EN(low)}$	—	$T_J > 158^{\circ}\text{C}$

## 8 Application and Implementation

### NOTE

Information in the following applications sections is not part of the TI component specification, and TI does not warrant its accuracy or completeness. TI's customers are responsible for determining suitability of components for their purposes. Customers should validate and test their design implementation to confirm system functionality.

### 8.1 Application Information

The TPS706 consumes low quiescent current and delivers excellent line and load transient performance. This performance, combined with low noise and good PSRR with little ( $V_{IN} - V_{OUT}$ ) headroom, makes these devices ideal for RF portable applications, current limit, and thermal protection. The TPS706 devices are specified from  $-40^{\circ}\text{C}$  to  $125^{\circ}\text{C}$ .

#### 8.1.1 Input and Output Capacitor Considerations

The TPS706 devices are stable with output capacitors with an effective capacitance of  $2.0\ \mu\text{F}$  or greater for output voltages below  $1.5\ \text{V}$ . For output voltages equal or greater than  $1.5\ \text{V}$ , the minimum effective capacitance for stability is  $1.5\ \mu\text{F}$ . The maximum capacitance for stability is  $47\ \mu\text{F}$ . The equivalent series resistance (ESR) of the output capacitor must be between  $0\ \Omega$  and  $0.2\ \Omega$  for stability.

The effective capacitance is the minimum capacitance value of a capacitor after taking into account variations resulting from tolerances, temperature, and dc bias effects. X5R- and X7R-type ceramic capacitors are recommended because these capacitors have minimal variation in value and ESR over temperature.

Although an input capacitor is not required for stability, good analog design practice is to connect a  $0.1\text{-}\mu\text{F}$  to  $2.2\text{-}\mu\text{F}$  capacitor from IN to GND. This capacitor counteracts reactive input sources and improves transient response, input ripple rejection, and PSRR.

#### 8.1.2 Dropout Voltage

The TPS706 uses a PMOS pass transistor to achieve low dropout. When ( $V_{IN} - V_{OUT}$ ) is less than the dropout voltage ( $V_{DO}$ ), the PMOS pass device is in the linear region of operation and the input-to-output resistance is the  $R_{DS(ON)}$  of the PMOS pass element.  $V_{DO}$  approximately scales with the output current because the PMOS device functions like a resistor in dropout.

The ground pin current of many linear voltage regulators increases substantially when the device is operated in dropout. This increase in ground pin current while operating in dropout can be several orders of magnitude larger than when the device is not in dropout. The TPS706 employs a special control loop that limits the increase in ground pin current while operating in dropout. This functionality allows for the most efficient operation while in dropout conditions that can greatly increase battery run times.

#### 8.1.3 Transient Response

As with any regulator, increasing the output capacitor size reduces over- and undershoot magnitude, but increases transient response duration.

## 8.2 Typical Application

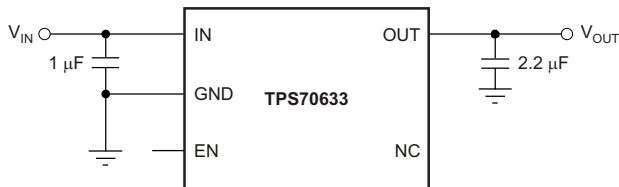

Figure 30. 3.3-V, Low- $I_Q$  Rail

### 8.2.1 Design Requirements

Table 2 summarizes the design requirements for Figure 30.

Table 2. Design Requirements for a 3.3-V, Low- $I_Q$  Rail Application

PARAMETER	DESIGN SPECIFICATION
$V_{IN}$	4.3 V
$V_{OUT}$	3.3 V
$I_{(IN)}$ (no load)	< 5 $\mu$ A
$I_{OUT}$ (max)	150 mA

### 8.2.2 Detailed Design Procedure

Select a 2.2- $\mu$ F, 10-V X7R output capacitor to satisfy the minimum output capacitance requirement with a 3.3-V dc bias.

Select a 1.0- $\mu$ F, 6.3-V X7R input capacitor to provide input noise filtering and eliminate high-frequency voltage transients.

### 8.2.3 Application Curves

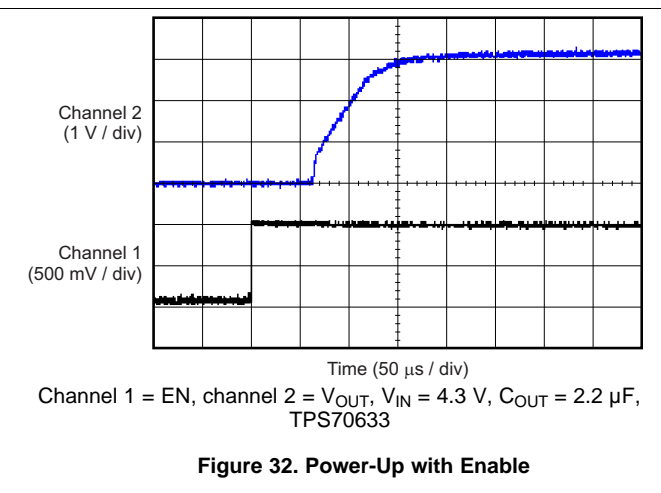
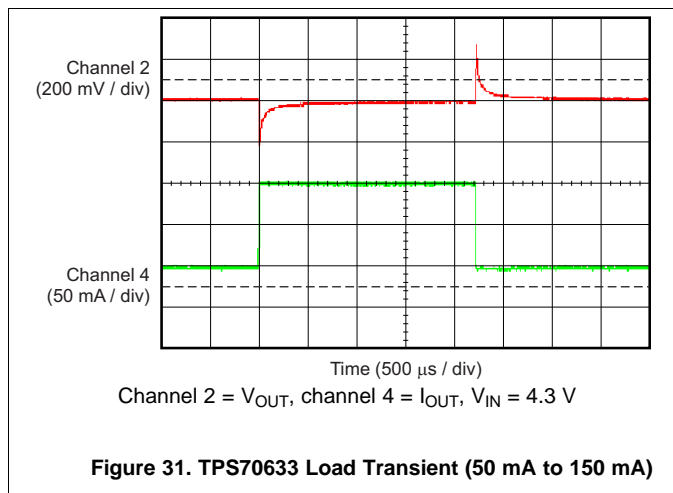

## 9 Power Supply Recommendations

This device is designed to operate with an input supply range of 2.7 V to 6.5 V. The input voltage range must provide adequate headroom in order for the device to have a regulated output. This input supply must be well-regulated and stable. If the input supply is noisy, additional input capacitors with low ESR can help improve the output noise performance.

## 10 Layout

### 10.1 Layout Guidelines

#### 10.1.1 Board Layout Recommendations to Improve PSRR and Noise Performance

Input and output capacitors must be placed as close to the device pins as possible. To improve ac performance (such as PSRR, output noise, and transient response), TI recommends that the board be designed with separate ground planes for  $V_{IN}$  and  $V_{OUT}$ , with the ground plane connected only at the device GND pin. In addition, the output capacitor ground connection must be connected directly to the device GND pin.

#### 10.1.2 Power Dissipation

The ability to remove heat from the die is different for each package type, presenting different considerations in the printed circuit board (PCB) layout. The PCB area around the device that is free of other components moves the heat from the device to the ambient air. Performance data for JEDEC low- and high-K boards are given in the [Thermal Information](#). Using heavier copper increases the effectiveness in removing heat from the device. The addition of plated through-holes to heat-dissipating layers also improves the heatsink effectiveness.

Power dissipation depends on input voltage and load conditions. Power dissipation ( $P_D$ ) can be approximated by the product of the output current times the voltage drop across the output pass element ( $V_{IN}$  to  $V_{OUT}$ ), as shown in [Equation 1](#).

$$P_D = (V_{IN} - V_{OUT}) \times I_{OUT} \quad (1)$$

[Figure 33](#) shows the maximum ambient temperature versus the power dissipation of the TPS706. This figure assumes the device is soldered on a JEDEC standard, high-K layout with no airflow over the board. Actual board thermal impedances vary widely. If the application requires high power dissipation, having a thorough understanding of the board temperature and thermal impedances is helpful to ensure the TPS706 does not operate above a junction temperature of 125°C.

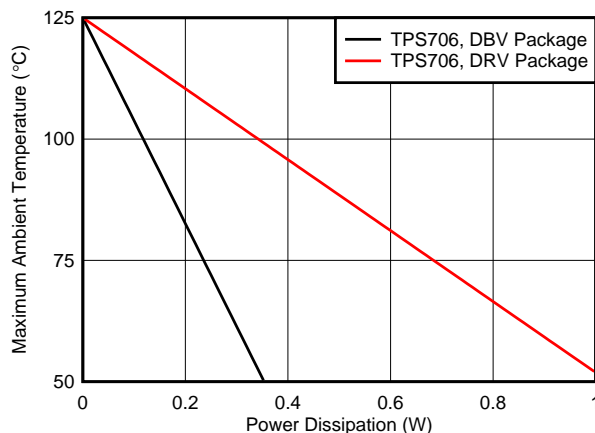

**Figure 33. Maximum Ambient Temperature vs Device Power Dissipation**



## Layout Guidelines (continued)

Estimating the junction temperature can be done by using the thermal metrics  $\Psi_{JT}$  and  $\Psi_{JB}$ , shown in the [Thermal Information](#). These metrics are a more accurate representation of the heat transfer characteristics of the die and the package than  $R_{\theta JA}$ . The junction temperature can be estimated with [Equation 2](#).

$$\Psi_{JT}: T_J = T_T + \Psi_{JT} \cdot P_D$$

$$\Psi_{JB}: T_J = T_B + \Psi_{JB} \cdot P_D$$

where:

- $P_D$  is the power dissipation shown by [Equation 1](#),
- $T_T$  is the temperature at the center-top of the IC package,
- $T_B$  is the PCB temperature measured 1 mm away from the IC package *on the PCB surface*. (2)

---

### NOTE

Both  $T_T$  and  $T_B$  can be measured on actual application boards using a thermo-gun (an infrared thermometer).

---

For more information about measuring  $T_T$  and  $T_B$ , see the application note [Using New Thermal Metrics \(SBVA025\)](#), available for download at [www.ti.com](http://www.ti.com).

## 10.2 Layout Examples

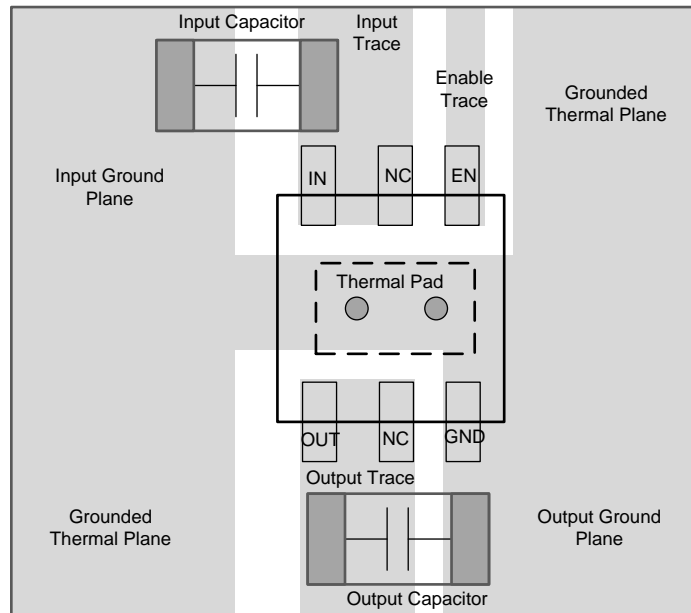

● Designates thermal vias.

**Figure 34. WSON Layout Example**

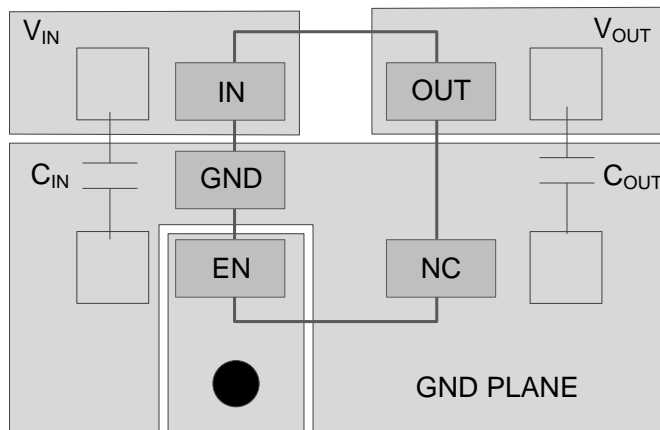

● Represents via used for application-specific connections.

**Figure 35. SOT23-5 Layout Example**

## 11 Device and Documentation Support

### 11.1 Device Support

#### 11.1.1 Development Support

##### 11.1.1.1 Spice Models

Computer simulation of circuit performance using SPICE is often useful when analyzing the performance of analog circuits and systems. A SPICE model for the TPS706 is available through the product folders under *Simulation Models*.

#### 11.1.2 Device Nomenclature

**Table 3. Device Nomenclature<sup>(1)</sup>**

PRODUCT	V <sub>OUT</sub>
TPS706xx yyy z	<p><b>xx</b> is the nominal output voltage. For output voltages with a resolution of 100 mV, two digits are used in the ordering number; otherwise, three digits are used (for example, 28 = 2.8 V).</p> <p><b>yyy</b> is the package designator.</p> <p><b>z</b> is the tape and reel quantity (R = 3000, T = 250).</p>

(1) For the most current package and ordering information see the Package Option Addendum at the end of this document, or see the TI web site at [www.ti.com](http://www.ti.com).

### 11.2 Documentation Support

#### 11.2.1 Related Documentation

[SBVU002](#) — DEM-SOT23LDO Demonstration Fixture

[SBVA025](#) — *Using New Thermal Metrics*

### 11.3 Trademarks

All trademarks are the property of their respective owners.

### 11.4 Electrostatic Discharge Caution



This integrated circuit can be damaged by ESD. Texas Instruments recommends that all integrated circuits be handled with appropriate precautions. Failure to observe proper handling and installation procedures can cause damage.

ESD damage can range from subtle performance degradation to complete device failure. Precision integrated circuits may be more susceptible to damage because very small parametric changes could cause the device not to meet its published specifications.

### 11.5 Glossary

[SLYZ022](#) — *TI Glossary*.

This glossary lists and explains terms, acronyms, and definitions.

## 12 Mechanical, Packaging, and Orderable Information

The following pages include mechanical, packaging, and orderable information. This information is the most current data available for the designated devices. This data is subject to change without notice and revision of this document. For browser-based versions of this data sheet, refer to the left-hand navigation.

**PACKAGING INFORMATION**

Orderable Device	Status (1)	Package Type	Package Drawing	Pins	Package Qty	Eco Plan (2)	Lead finish/ Ball material (6)	MSL Peak Temp (3)	Op Temp (°C)	Device Marking (4/5)	Samples
TPS70612DBVR	ACTIVE	SOT-23	DBV	5	3000	RoHS & Green	NIPDAU	Level-1-260C-UNLIM	-40 to 125	SJC	<a href="#">Samples</a>
TPS70612DBVT	ACTIVE	SOT-23	DBV	5	250	RoHS & Green	NIPDAU	Level-1-260C-UNLIM	-40 to 125	SJC	<a href="#">Samples</a>
TPS70612DRVR	ACTIVE	WSON	DRV	6	3000	RoHS & Green	NIPDAU	Level-1-260C-UNLIM	-40 to 125	SJC	<a href="#">Samples</a>
TPS70612DRVT	ACTIVE	WSON	DRV	6	250	RoHS & Green	NIPDAU	Level-1-260C-UNLIM	-40 to 125	SJC	<a href="#">Samples</a>
TPS70615DBVR	ACTIVE	SOT-23	DBV	5	3000	RoHS & Green	NIPDAU	Level-1-260C-UNLIM	-40 to 125	SIW	<a href="#">Samples</a>
TPS70615DBVT	ACTIVE	SOT-23	DBV	5	250	RoHS & Green	NIPDAU	Level-1-260C-UNLIM	-40 to 125	SIW	<a href="#">Samples</a>
TPS70615DRVR	ACTIVE	WSON	DRV	6	3000	RoHS & Green	NIPDAU	Level-1-260C-UNLIM	-40 to 125	SIW	<a href="#">Samples</a>
TPS70615DRVT	ACTIVE	WSON	DRV	6	250	RoHS & Green	NIPDAU	Level-1-260C-UNLIM	-40 to 125	SIW	<a href="#">Samples</a>
TPS70618DBVR	ACTIVE	SOT-23	DBV	5	3000	RoHS & Green	NIPDAU	Level-1-260C-UNLIM	-40 to 125	SIX	<a href="#">Samples</a>
TPS70618DBVT	ACTIVE	SOT-23	DBV	5	250	RoHS & Green	NIPDAU	Level-1-260C-UNLIM	-40 to 125	SIX	<a href="#">Samples</a>
TPS70618DRVR	ACTIVE	WSON	DRV	6	3000	RoHS & Green	NIPDAU	Level-1-260C-UNLIM	-40 to 125	SIX	<a href="#">Samples</a>
TPS70618DRVT	ACTIVE	WSON	DRV	6	250	RoHS & Green	NIPDAU	Level-1-260C-UNLIM	-40 to 125	SIX	<a href="#">Samples</a>
TPS70625DBVR	ACTIVE	SOT-23	DBV	5	3000	RoHS & Green	NIPDAU	Level-1-260C-UNLIM	-40 to 125	SIY	<a href="#">Samples</a>
TPS70625DBVT	ACTIVE	SOT-23	DBV	5	250	RoHS & Green	NIPDAU	Level-1-260C-UNLIM	-40 to 125	SIY	<a href="#">Samples</a>
TPS70625DRVR	ACTIVE	WSON	DRV	6	3000	RoHS & Green	NIPDAU	Level-1-260C-UNLIM	-40 to 125	SIY	<a href="#">Samples</a>
TPS70625DRVT	ACTIVE	WSON	DRV	6	250	RoHS & Green	NIPDAU	Level-1-260C-UNLIM	-40 to 125	SIY	<a href="#">Samples</a>
TPS70628DBVR	ACTIVE	SOT-23	DBV	5	3000	RoHS & Green	NIPDAU	Level-1-260C-UNLIM	-40 to 125	SJU	<a href="#">Samples</a>
TPS70628DBVT	ACTIVE	SOT-23	DBV	5	250	RoHS & Green	NIPDAU	Level-1-260C-UNLIM	-40 to 125	SJU	<a href="#">Samples</a>
TPS70628DRVR	ACTIVE	WSON	DRV	6	3000	RoHS & Green	NIPDAU	Level-1-260C-UNLIM	-40 to 125	SJU	<a href="#">Samples</a>
TPS70628DRVT	ACTIVE	WSON	DRV	6	250	RoHS & Green	NIPDAU	Level-1-260C-UNLIM	-40 to 125	SJU	<a href="#">Samples</a>

Orderable Device	Status (1)	Package Type	Package Drawing	Pins	Package Qty	Eco Plan (2)	Lead finish/ Ball material (6)	MSL Peak Temp (3)	Op Temp (°C)	Device Marking (4/5)	Samples
TPS70630DBVR	ACTIVE	SOT-23	DBV	5	3000	RoHS & Green	NIPDAU	Level-1-260C-UNLIM	-40 to 125	SIZ	<a href="#">Samples</a>
TPS70630DBVT	ACTIVE	SOT-23	DBV	5	250	RoHS & Green	NIPDAU	Level-1-260C-UNLIM	-40 to 125	SIZ	<a href="#">Samples</a>
TPS70630DRVR	ACTIVE	WSON	DRV	6	3000	RoHS & Green	NIPDAU	Level-1-260C-UNLIM	-40 to 125	SIZ	<a href="#">Samples</a>
TPS70630DRVT	ACTIVE	WSON	DRV	6	250	RoHS & Green	NIPDAU	Level-1-260C-UNLIM	-40 to 125	SIZ	<a href="#">Samples</a>
TPS70633DBVR	ACTIVE	SOT-23	DBV	5	3000	RoHS & Green	NIPDAU	Level-1-260C-UNLIM	-40 to 125	SJA	<a href="#">Samples</a>
TPS70633DBVT	ACTIVE	SOT-23	DBV	5	250	RoHS & Green	NIPDAU	Level-1-260C-UNLIM	-40 to 125	SJA	<a href="#">Samples</a>
TPS70633DRVR	ACTIVE	WSON	DRV	6	3000	RoHS & Green	NIPDAU	Level-1-260C-UNLIM	-40 to 125	SJA	<a href="#">Samples</a>
TPS70633DRVT	ACTIVE	WSON	DRV	6	250	RoHS & Green	NIPDAU	Level-1-260C-UNLIM	-40 to 125	SJA	<a href="#">Samples</a>

(1) The marketing status values are defined as follows:

**ACTIVE:** Product device recommended for new designs.

**LIFEBUY:** TI has announced that the device will be discontinued, and a lifetime-buy period is in effect.

**NRND:** Not recommended for new designs. Device is in production to support existing customers, but TI does not recommend using this part in a new design.

**PREVIEW:** Device has been announced but is not in production. Samples may or may not be available.

**OBSOLETE:** TI has discontinued the production of the device.

(2) **RoHS:** TI defines "RoHS" to mean semiconductor products that are compliant with the current EU RoHS requirements for all 10 RoHS substances, including the requirement that RoHS substance do not exceed 0.1% by weight in homogeneous materials. Where designed to be soldered at high temperatures, "RoHS" products are suitable for use in specified lead-free processes. TI may reference these types of products as "Pb-Free".

**RoHS Exempt:** TI defines "RoHS Exempt" to mean products that contain lead but are compliant with EU RoHS pursuant to a specific EU RoHS exemption.

**Green:** TI defines "Green" to mean the content of Chlorine (Cl) and Bromine (Br) based flame retardants meet JS709B low halogen requirements of <=1000ppm threshold. Antimony trioxide based flame retardants must also meet the <=1000ppm threshold requirement.

(3) MSL, Peak Temp. - The Moisture Sensitivity Level rating according to the JEDEC industry standard classifications, and peak solder temperature.

(4) There may be additional marking, which relates to the logo, the lot trace code information, or the environmental category on the device.

(5) Multiple Device Markings will be inside parentheses. Only one Device Marking contained in parentheses and separated by a "~" will appear on a device. If a line is indented then it is a continuation of the previous line and the two combined represent the entire Device Marking for that device.

<sup>(6)</sup> Lead finish/Ball material - Orderable Devices may have multiple material finish options. Finish options are separated by a vertical ruled line. Lead finish/Ball material values may wrap to two lines if the finish value exceeds the maximum column width.

**Important Information and Disclaimer:**The information provided on this page represents TI's knowledge and belief as of the date that it is provided. TI bases its knowledge and belief on information provided by third parties, and makes no representation or warranty as to the accuracy of such information. Efforts are underway to better integrate information from third parties. TI has taken and continues to take reasonable steps to provide representative and accurate information but may not have conducted destructive testing or chemical analysis on incoming materials and chemicals. TI and TI suppliers consider certain information to be proprietary, and thus CAS numbers and other limited information may not be available for release.

In no event shall TI's liability arising out of such information exceed the total purchase price of the TI part(s) at issue in this document sold by TI to Customer on an annual basis.

**TAPE AND REEL INFORMATION**

**QUADRANT ASSIGNMENTS FOR PIN 1 ORIENTATION IN TAPE**

\*All dimensions are nominal

Device	Package Type	Package Drawing	Pins	SPQ	Reel Diameter (mm)	Reel Width W1 (mm)	A0 (mm)	B0 (mm)	K0 (mm)	P1 (mm)	W (mm)	Pin1 Quadrant
TPS70612DBVR	SOT-23	DBV	5	3000	178.0	9.0	3.3	3.2	1.4	4.0	8.0	Q3
TPS70612DBVT	SOT-23	DBV	5	250	178.0	9.0	3.3	3.2	1.4	4.0	8.0	Q3
TPS70612DRVR	WSO	DRV	6	3000	180.0	8.4	2.3	2.3	1.15	4.0	8.0	Q2
TPS70612DRVT	WSO	DRV	6	250	180.0	8.4	2.3	2.3	1.15	4.0	8.0	Q2
TPS70615DBVR	SOT-23	DBV	5	3000	178.0	9.0	3.3	3.2	1.4	4.0	8.0	Q3
TPS70615DBVT	SOT-23	DBV	5	250	178.0	9.0	3.3	3.2	1.4	4.0	8.0	Q3
TPS70615DRVR	WSO	DRV	6	3000	180.0	8.4	2.3	2.3	1.15	4.0	8.0	Q2
TPS70615DRVT	WSO	DRV	6	250	180.0	8.4	2.3	2.3	1.15	4.0	8.0	Q2
TPS70618DBVR	SOT-23	DBV	5	3000	178.0	9.0	3.3	3.2	1.4	4.0	8.0	Q3
TPS70618DBVT	SOT-23	DBV	5	250	178.0	9.0	3.3	3.2	1.4	4.0	8.0	Q3
TPS70618DRVR	WSO	DRV	6	3000	180.0	8.4	2.3	2.3	1.15	4.0	8.0	Q2
TPS70618DRVT	WSO	DRV	6	250	180.0	8.4	2.3	2.3	1.15	4.0	8.0	Q2
TPS70625DBVR	SOT-23	DBV	5	3000	178.0	9.0	3.3	3.2	1.4	4.0	8.0	Q3
TPS70625DBVT	SOT-23	DBV	5	250	178.0	9.0	3.3	3.2	1.4	4.0	8.0	Q3
TPS70625DRVR	WSO	DRV	6	3000	180.0	8.4	2.3	2.3	1.15	4.0	8.0	Q2
TPS70625DRVT	WSO	DRV	6	250	180.0	8.4	2.3	2.3	1.15	4.0	8.0	Q2

Device	Package Type	Package Drawing	Pins	SPQ	Reel Diameter (mm)	Reel Width W1 (mm)	A0 (mm)	B0 (mm)	K0 (mm)	P1 (mm)	W (mm)	Pin1 Quadrant
TPS70628DBVR	SOT-23	DBV	5	3000	178.0	9.0	3.3	3.2	1.4	4.0	8.0	Q3
TPS70628DBVT	SOT-23	DBV	5	250	178.0	9.0	3.3	3.2	1.4	4.0	8.0	Q3
TPS70628DRVR	WSON	DRV	6	3000	180.0	8.4	2.3	2.3	1.15	4.0	8.0	Q2
TPS70628DRVT	WSON	DRV	6	250	180.0	8.4	2.3	2.3	1.15	4.0	8.0	Q2
TPS70630DBVR	SOT-23	DBV	5	3000	178.0	9.0	3.3	3.2	1.4	4.0	8.0	Q3
TPS70630DBVT	SOT-23	DBV	5	250	178.0	9.0	3.3	3.2	1.4	4.0	8.0	Q3
TPS70630DRVR	WSON	DRV	6	3000	180.0	8.4	2.3	2.3	1.15	4.0	8.0	Q2
TPS70630DRVT	WSON	DRV	6	250	180.0	8.4	2.3	2.3	1.15	4.0	8.0	Q2
TPS70633DBVR	SOT-23	DBV	5	3000	178.0	9.0	3.3	3.2	1.4	4.0	8.0	Q3
TPS70633DBVT	SOT-23	DBV	5	250	178.0	9.0	3.3	3.2	1.4	4.0	8.0	Q3
TPS70633DRVR	WSON	DRV	6	3000	180.0	8.4	2.3	2.3	1.15	4.0	8.0	Q2
TPS70633DRVT	WSON	DRV	6	250	180.0	8.4	2.3	2.3	1.15	4.0	8.0	Q2



**TAPE AND REEL BOX DIMENSIONS**

\*All dimensions are nominal

Device	Package Type	Package Drawing	Pins	SPQ	Length (mm)	Width (mm)	Height (mm)
TPS70612DBVR	SOT-23	DBV	5	3000	180.0	180.0	18.0
TPS70612DBVT	SOT-23	DBV	5	250	180.0	180.0	18.0
TPS70612DRVR	WSON	DRV	6	3000	182.0	182.0	20.0
TPS70612DRVT	WSON	DRV	6	250	182.0	182.0	20.0
TPS70615DBVR	SOT-23	DBV	5	3000	180.0	180.0	18.0
TPS70615DBVT	SOT-23	DBV	5	250	180.0	180.0	18.0
TPS70615DRVR	WSON	DRV	6	3000	182.0	182.0	20.0
TPS70615DRVT	WSON	DRV	6	250	182.0	182.0	20.0
TPS70618DBVR	SOT-23	DBV	5	3000	180.0	180.0	18.0
TPS70618DBVT	SOT-23	DBV	5	250	180.0	180.0	18.0
TPS70618DRVR	WSON	DRV	6	3000	182.0	182.0	20.0
TPS70618DRVT	WSON	DRV	6	250	182.0	182.0	20.0
TPS70625DBVR	SOT-23	DBV	5	3000	180.0	180.0	18.0
TPS70625DBVT	SOT-23	DBV	5	250	180.0	180.0	18.0
TPS70625DRVR	WSON	DRV	6	3000	182.0	182.0	20.0
TPS70625DRVT	WSON	DRV	6	250	182.0	182.0	20.0
TPS70628DBVR	SOT-23	DBV	5	3000	180.0	180.0	18.0
TPS70628DBVT	SOT-23	DBV	5	250	180.0	180.0	18.0

Device	Package Type	Package Drawing	Pins	SPQ	Length (mm)	Width (mm)	Height (mm)
TPS70628DRVR	WSON	DRV	6	3000	182.0	182.0	20.0
TPS70628DRVT	WSON	DRV	6	250	182.0	182.0	20.0
TPS70630DBVR	SOT-23	DBV	5	3000	180.0	180.0	18.0
TPS70630DBVT	SOT-23	DBV	5	250	180.0	180.0	18.0
TPS70630DRVR	WSON	DRV	6	3000	182.0	182.0	20.0
TPS70630DRVT	WSON	DRV	6	250	182.0	182.0	20.0
TPS70633DBVR	SOT-23	DBV	5	3000	180.0	180.0	18.0
TPS70633DBVT	SOT-23	DBV	5	250	180.0	180.0	18.0
TPS70633DRVR	WSON	DRV	6	3000	182.0	182.0	20.0
TPS70633DRVT	WSON	DRV	6	250	182.0	182.0	20.0



# EXAMPLE BOARD LAYOUT

DBV0005A

SOT-23 - 1.45 mm max height

SMALL OUTLINE TRANSISTOR

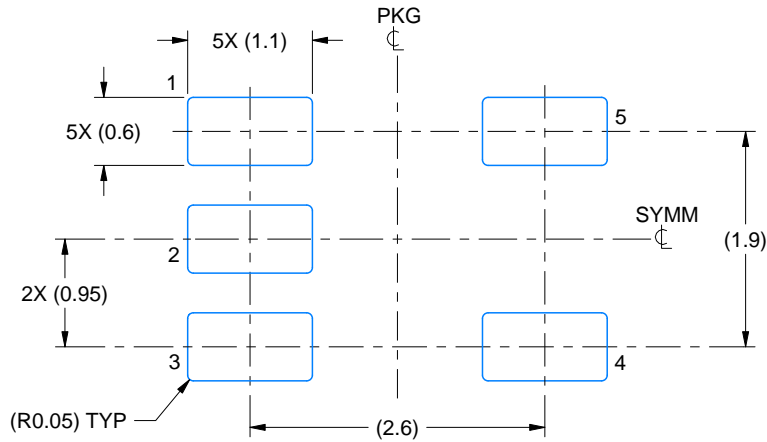

LAND PATTERN EXAMPLE  
EXPOSED METAL SHOWN  
SCALE:15X

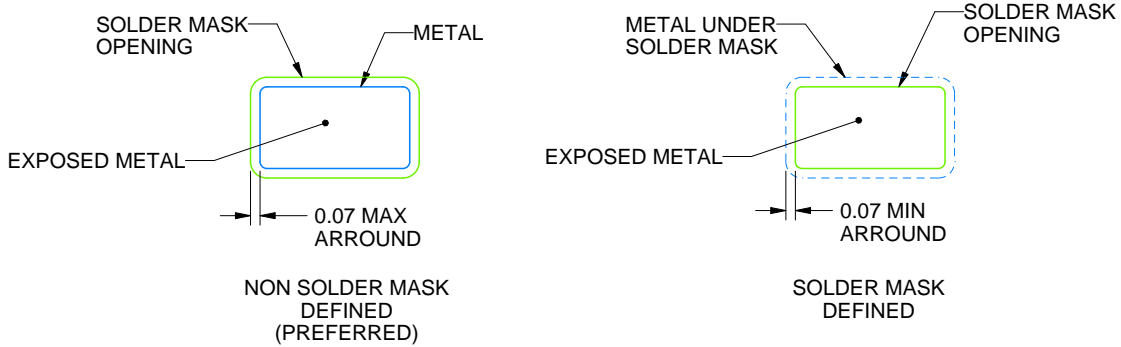

SOLDER MASK DETAILS

4214839/K 08/2024

NOTES: (continued)

- 6. Publication IPC-7351 may have alternate designs.
- 7. Solder mask tolerances between and around signal pads can vary based on board fabrication site.

# EXAMPLE STENCIL DESIGN

DBV0005A

SOT-23 - 1.45 mm max height

SMALL OUTLINE TRANSISTOR

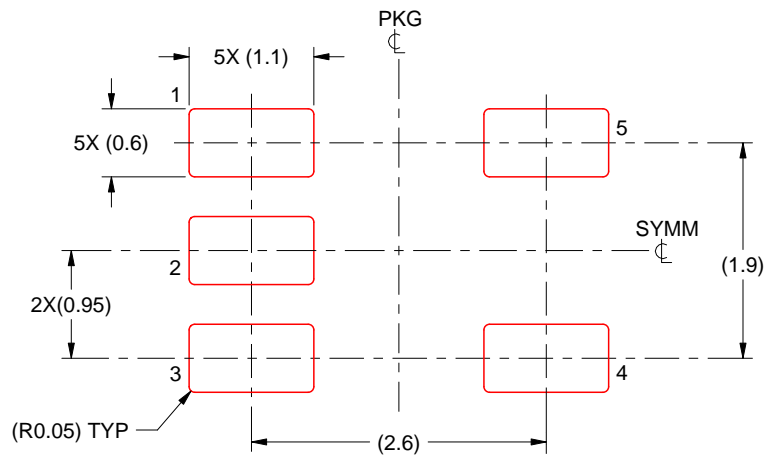

SOLDER PASTE EXAMPLE  
BASED ON 0.125 mm THICK STENCIL  
SCALE:15X

4214839/K 08/2024

NOTES: (continued)

8. Laser cutting apertures with trapezoidal walls and rounded corners may offer better paste release. IPC-7525 may have alternate design recommendations.
9. Board assembly site may have different recommendations for stencil design.

## GENERIC PACKAGE VIEW

DRV 6

WSON - 0.8 mm max height

PLASTIC SMALL OUTLINE - NO LEAD

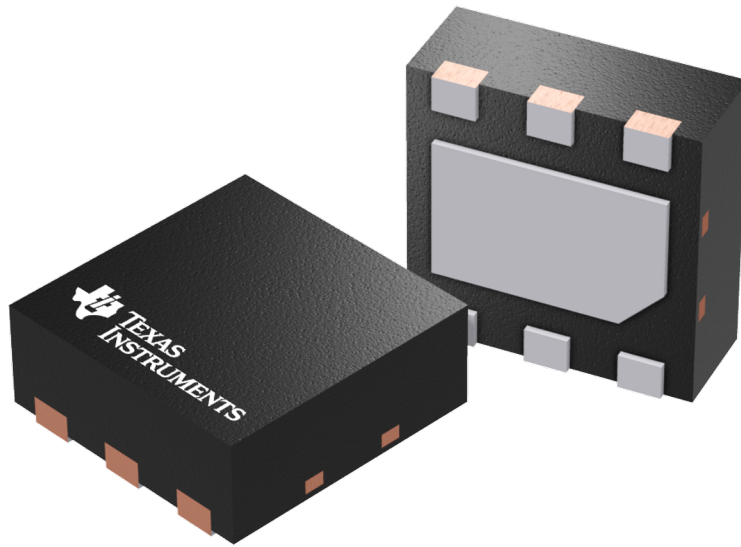

Images above are just a representation of the package family, actual package may vary.  
Refer to the product data sheet for package details.

4206925/F

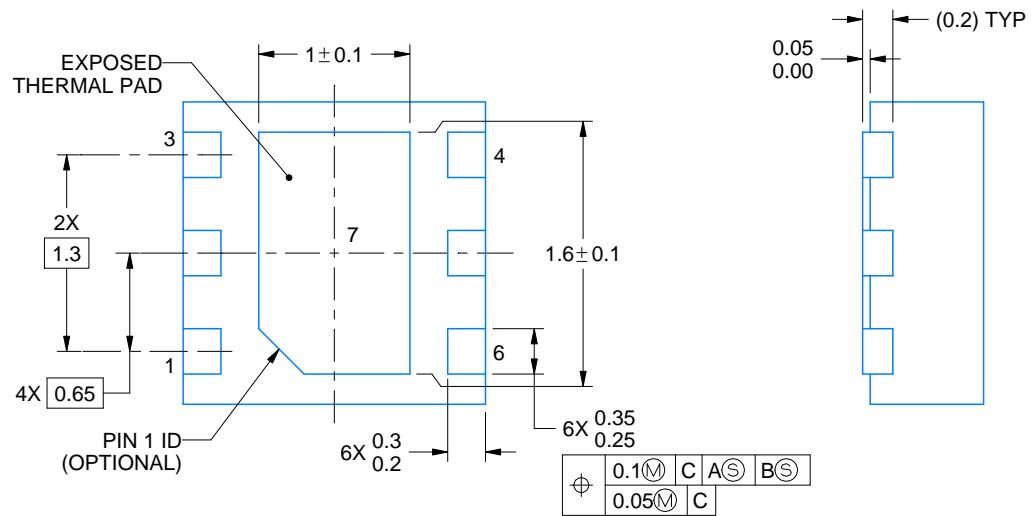
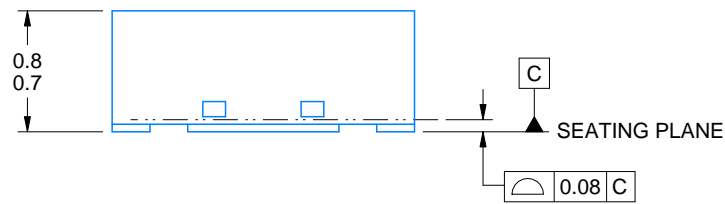
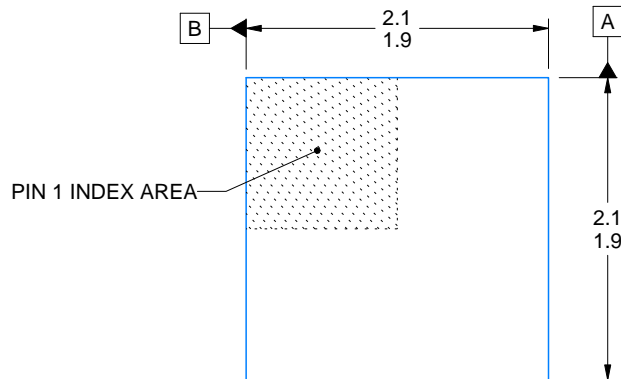
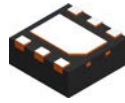

4222173/B 04/2018

NOTES:

1. All linear dimensions are in millimeters. Any dimensions in parenthesis are for reference only. Dimensioning and tolerancing per ASME Y14.5M.
2. This drawing is subject to change without notice.
3. The package thermal pad must be soldered to the printed circuit board for thermal and mechanical performance.





# EXAMPLE STENCIL DESIGN

DRV0006A

WSON - 0.8 mm max height

PLASTIC SMALL OUTLINE - NO LEAD

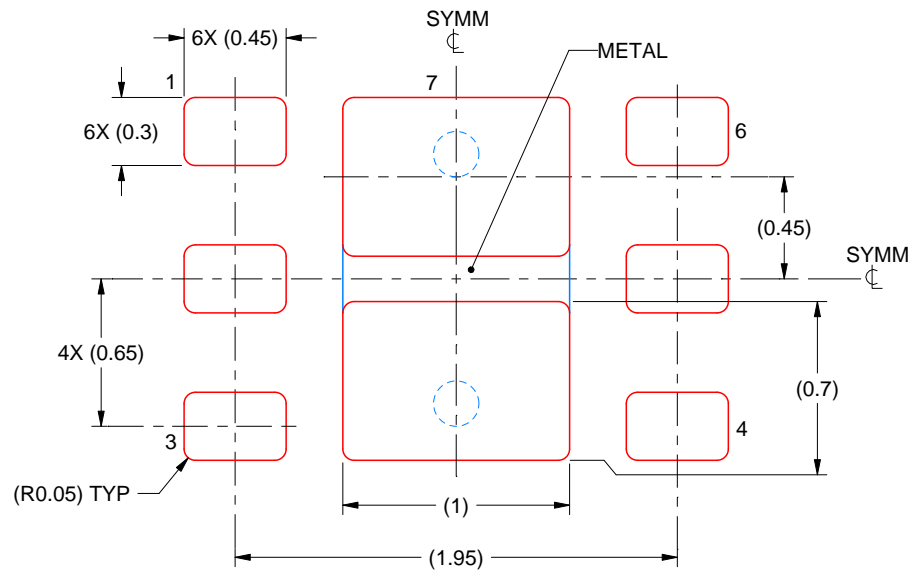

SOLDER PASTE EXAMPLE  
BASED ON 0.125 mm THICK STENCIL

EXPOSED PAD #7  
88% PRINTED SOLDER COVERAGE BY AREA UNDER PACKAGE  
SCALE:30X

4222173/B 04/2018

NOTES: (continued)

6. Laser cutting apertures with trapezoidal walls and rounded corners may offer better paste release. IPC-7525 may have alternate design recommendations.

## IMPORTANT NOTICE AND DISCLAIMER

TI PROVIDES TECHNICAL AND RELIABILITY DATA (INCLUDING DATA SHEETS), DESIGN RESOURCES (INCLUDING REFERENCE DESIGNS), APPLICATION OR OTHER DESIGN ADVICE, WEB TOOLS, SAFETY INFORMATION, AND OTHER RESOURCES "AS IS" AND WITH ALL FAULTS, AND DISCLAIMS ALL WARRANTIES, EXPRESS AND IMPLIED, INCLUDING WITHOUT LIMITATION ANY IMPLIED WARRANTIES OF MERCHANTABILITY, FITNESS FOR A PARTICULAR PURPOSE OR NON-INFRINGEMENT OF THIRD PARTY INTELLECTUAL PROPERTY RIGHTS.

These resources are intended for skilled developers designing with TI products. You are solely responsible for (1) selecting the appropriate TI products for your application, (2) designing, validating and testing your application, and (3) ensuring your application meets applicable standards, and any other safety, security, regulatory or other requirements.

These resources are subject to change without notice. TI grants you permission to use these resources only for development of an application that uses the TI products described in the resource. Other reproduction and display of these resources is prohibited. No license is granted to any other TI intellectual property right or to any third party intellectual property right. TI disclaims responsibility for, and you will fully indemnify TI and its representatives against, any claims, damages, costs, losses, and liabilities arising out of your use of these resources.

TI's products are provided subject to [TI's Terms of Sale](#) or other applicable terms available either on [ti.com](https://www.ti.com) or provided in conjunction with such TI products. TI's provision of these resources does not expand or otherwise alter TI's applicable warranties or warranty disclaimers for TI products.

TI objects to and rejects any additional or different terms you may have proposed.

Mailing Address: Texas Instruments, Post Office Box 655303, Dallas, Texas 75265  
Copyright © 2024, Texas Instruments Incorporated