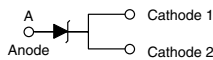

Surface Mount PAR[®] Transient Voltage Suppressors

Unidirectional 1500 W TVS in SMPC (TO-277) Package

TO-277A (SMPC)

RoHS
 COMPLIANT
 HALOGEN
FREE
FEATURES

- Junction passivation optimized design passivated anisotropic rectifier technology
- $T_J = 185\text{ }^\circ\text{C}$ capability suitable for high reliability and automotive requirement
- Very low profile - typical height of 1.1 mm
- Ideal for automated placement
- Unidirection only
- Excellent clamping capability
- Low incremental surge resistance
- Very fast response time
- Meets MSL level 1, per J-STD-020
- AEC-Q101 qualified
- Material categorization: for definitions of compliance please see www.vishay.com/doc?99912

LINKS TO ADDITIONAL RESOURCES

| PRIMARY CHARACTERISTICS | |
|-------------------------|-----------------|
| V_{WM} | 5.8 V to 43.6 V |
| V_{BR} | 6.8 V to 51 V |
| P_{PPM} | 1500 W |
| T_J max. | 185 °C |
| Polarity | Unidirectional |
| Package | SMPC (TO-277A) |

TYPICAL APPLICATIONS

Use in sensitive electronics protection against voltage transients induced by inductive load switching and lighting on ICs, MOSFET, signal lines of sensor units for consumer, computer, industrial, automotive, and telecommunication.

MECHANICAL DATA

Case: SMPC (TO-277A)

Molding compound meets UL 94 V-0 flammability rating Base P/NHM3_X - halogen-free, RoHS-compliant, and AEC-Q101 qualified ("X" denotes revision code e.g. A, B, ...)

Terminals: matte tin plated leads, solderable per J-STD-002 and JESD 22-B102

HM3 suffix meets JESD 201 class 2 whisker test

| MAXIMUM RATINGS ($T_A = 25\text{ }^\circ\text{C}$, unless otherwise noted) | | | |
|---|----------------|----------------|------|
| PARAMETER | SYMBOL | VALUE | UNIT |
| Peak power dissipation with a 10/1000 μs waveform (fig. 3) ⁽¹⁾⁽²⁾ | P_{PPM} | 1500 | W |
| Peak power pulse current with a 10/1000 μs waveform (fig. 1) ⁽¹⁾ | I_{PPM} | See next table | A |
| Peak forward surge current 8.3 ms single half sine-wave ⁽²⁾ | I_{FSM} | 200 | A |
| Maximum instantaneous forward voltage at 100 A ⁽³⁾ | V_F | 3.5 | V |
| Operating junction and storage temperature range | T_J, T_{STG} | -65 to +185 | °C |

Notes

- (1) Non-repetitive current pulse, per fig. 3 and derated above $T_A = 25\text{ }^\circ\text{C}$ per fig. 2
- (2) Measured on 8.3 ms single half sine-wave, or equivalent square wave, duty cycle = 4 pulses per minute maximum
- (3) Pulse test: 300 μs pulse width, 1 % duty cycle



| ELECTRICAL CHARACTERISTICS ($T_A = 25\text{ }^\circ\text{C}$, unless otherwise noted) | | | | | | | | | | | |
|--|---------------------|---|------|------|-------------------------|--------------------------------|---|---|--|---|--|
| DEVICE TYPE | DEVICE MARKING CODE | BREAKDOWN VOLTAGE $V_{BR}^{(1)}$ AT I_T (V) | | | TEST CURRENT I_T (mA) | STAND-OFF VOLTAGE V_{WM} (V) | MAXIMUM REVERSE LEAKAGE AT V_{WM} I_R (μA) | MAXIMUM REVERSE LEAKAGE AT V_{WM} $T_J = 150\text{ }^\circ\text{C}$ I_D (μA) | MAXIMUM PEAK PULSE SURGE CURRENT $I_{PPM}^{(2)}$ (A) | MAXIMUM CLAMPING VOLTAGE AT I_{PPM} V_C (V) | TYPICAL TEMP. COEFFICIENT OF $V_{BR}^{(3)}$ αT ($\%/^\circ\text{C}$) |
| | | MIN. | NOM. | MAX. | | | | | | | |
| TPC6.8A | DEP | 6.45 | 6.80 | 7.14 | 10 | 5.80 | 1500 | 10 000 | 143 | 10.5 | 0.047 |
| TPC7.5A | DGP | 7.13 | 7.50 | 7.88 | 10 | 6.40 | 500 | 5000 | 133 | 11.3 | 0.052 |
| TPC8.2A | DKP | 7.79 | 8.20 | 8.61 | 10 | 7.02 | 200 | 2000 | 124 | 12.1 | 0.056 |
| TPC9.1A | DMP | 8.65 | 9.10 | 9.55 | 1.0 | 7.78 | 50 | 500 | 112 | 13.4 | 0.060 |
| TPC10A | DPP | 9.5 | 10.0 | 10.5 | 1.0 | 8.55 | 20 | 200 | 103 | 14.5 | 0.064 |
| TPC11A | DRP | 10.5 | 11.0 | 11.6 | 1.0 | 9.40 | 5.0 | 50 | 96.2 | 15.6 | 0.067 |
| TPC12A | DTP | 11.4 | 12.0 | 12.6 | 1.0 | 10.2 | 2.0 | 10 | 89.8 | 16.7 | 0.070 |
| TPC13A | DVP | 12.4 | 13.0 | 13.7 | 1.0 | 11.1 | 2.0 | 10 | 82.4 | 18.2 | 0.072 |
| TPC15A | DXP | 14.3 | 15.0 | 15.8 | 1.0 | 12.8 | 1.0 | 10 | 70.8 | 21.2 | 0.076 |
| TPC16A | DZP | 15.2 | 16.0 | 16.8 | 1.0 | 13.6 | 1.0 | 10 | 66.7 | 22.5 | 0.078 |
| TPC18A | EEP | 17.1 | 18.0 | 18.9 | 1.0 | 15.3 | 1.0 | 10 | 59.5 | 25.2 | 0.080 |
| TPC20A | EGP | 19.0 | 20.0 | 21.0 | 1.0 | 17.1 | 1.0 | 10 | 54.2 | 27.7 | 0.082 |
| TPC22A | EKP | 20.9 | 22.0 | 23.1 | 1.0 | 18.8 | 1.0 | 10 | 49.0 | 30.6 | 0.084 |
| TPC24A | EMP | 22.8 | 24.0 | 25.2 | 1.0 | 20.5 | 1.0 | 10 | 45.2 | 33.2 | 0.085 |
| TPC27A | EPP | 25.7 | 27.0 | 28.4 | 1.0 | 23.1 | 1.0 | 10 | 40.0 | 37.5 | 0.087 |
| TPC30A | ERP | 28.5 | 30.0 | 31.5 | 1.0 | 25.6 | 1.0 | 10 | 36.2 | 41.4 | 0.088 |
| TPC33A | ETP | 31.4 | 33.0 | 34.7 | 1.0 | 28.2 | 1.0 | 10 | 32.8 | 45.7 | 0.089 |
| TPC36A | EVP | 34.2 | 36.0 | 37.8 | 1.0 | 30.8 | 1.0 | 15 | 30.1 | 49.9 | 0.090 |
| TPC39A | EXP | 37.1 | 39.0 | 41.0 | 1.0 | 33.3 | 1.0 | 15 | 27.8 | 53.9 | 0.091 |
| TPC43A | EZP | 40.9 | 43.0 | 45.2 | 1.0 | 36.8 | 1.0 | 20 | 25.3 | 59.3 | 0.092 |
| TPC47A | FEP | 44.7 | 47.0 | 49.4 | 1.0 | 40.2 | 1.0 | 20 | 23.1 | 64.8 | 0.092 |
| TPC51A | FGP | 48.5 | 51.0 | 53.6 | 1.0 | 43.6 | 1.0 | 20 | 21.4 | 70.1 | 0.093 |

Notes

- (1) V_{BR} measured after I_T applied for 300 μs , I_T = square wave pulse or equivalent
(2) Surge current waveform per fig. 3 and derated per fig. 2
(3) To calculate V_{BR} vs. junction temperature, use the following formula: V_{BR} at $T_J = V_{BR}$ at $25\text{ }^\circ\text{C} \times (1 + \alpha T \times (T_J - 25))$
(4) All terms and symbols are consistent with ANSI/IEEE C62.35

| ORDERING INFORMATION (Example) | | | | |
|---------------------------------------|-----------------|------------------------|---------------|------------------------------------|
| PREFERRED P/N | UNIT WEIGHT (g) | PREFERRED PACKAGE CODE | BASE QUANTITY | DELIVERY MODE |
| TPC10AHM3_A/H ⁽¹⁾ | 0.10 | H | 1500 | 7" diameter plastic tape and reel |
| TPC10AHM3_A/I ⁽¹⁾ | 0.10 | I | 6500 | 13" diameter plastic tape and reel |

Note

- (1) Automotive grade



RATINGS AND CHARACTERISTICS CURVES ($T_A = 25\text{ }^\circ\text{C}$, unless otherwise noted)

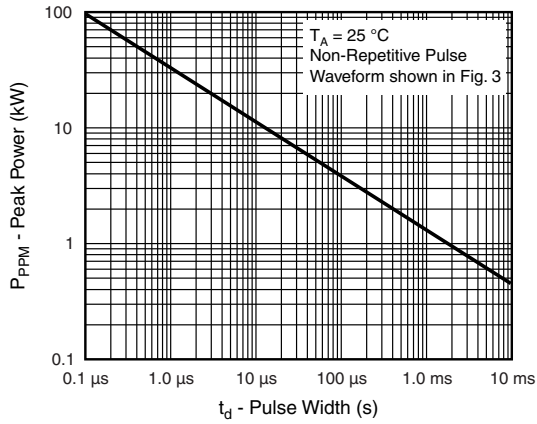

Fig. 1 - Peak Pulse Power Rating Curve

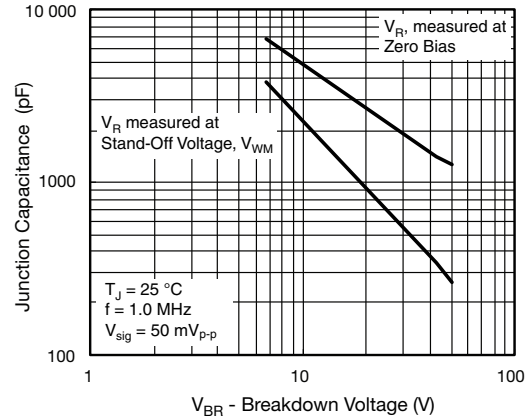

Fig. 4 - Typical Junction Capacitance

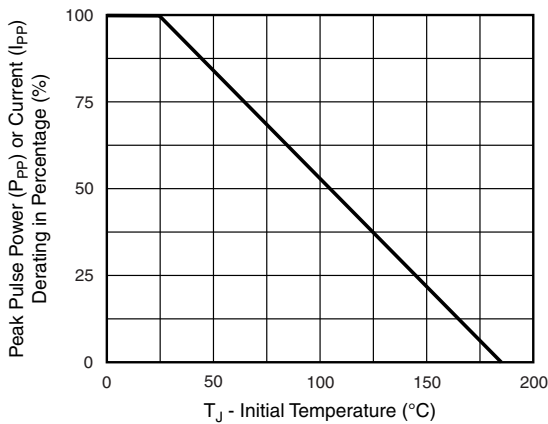

Fig. 2 - Pulse Power or Current vs. Initial Junction Temperature

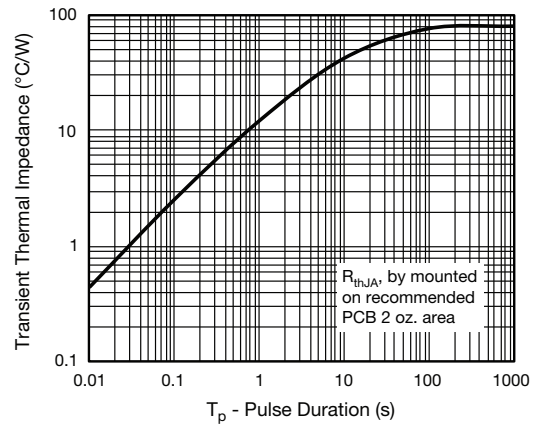

Fig. 5 - Typical Transient Thermal Impedance

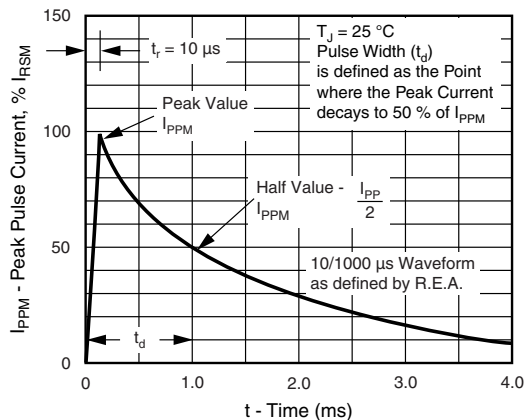
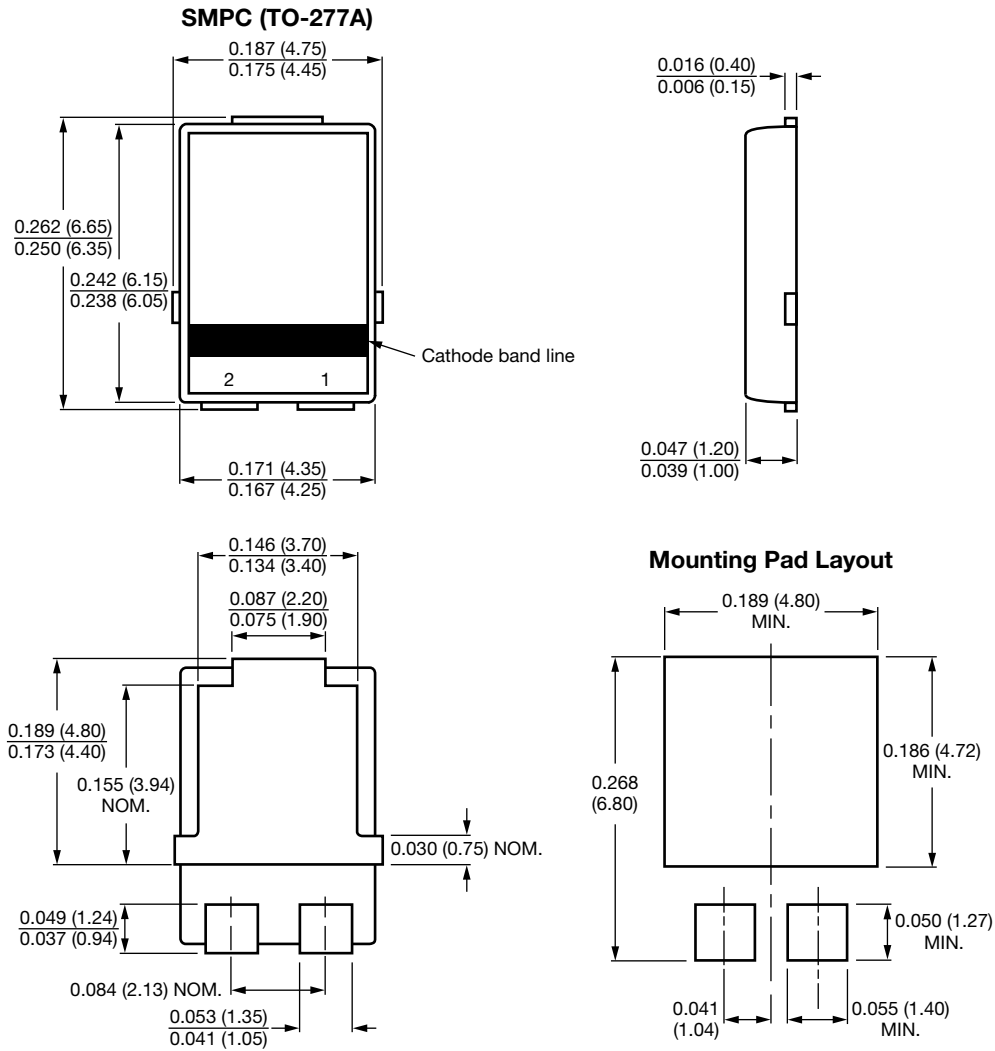

Fig. 3 - Pulse Waveform



PACKAGE OUTLINE DIMENSIONS in inches (millimeters)



Conform to JEDEC® TO-277A



Disclaimer

ALL PRODUCT, PRODUCT SPECIFICATIONS AND DATA ARE SUBJECT TO CHANGE WITHOUT NOTICE TO IMPROVE RELIABILITY, FUNCTION OR DESIGN OR OTHERWISE.

Vishay Intertechnology, Inc., its affiliates, agents, and employees, and all persons acting on its or their behalf (collectively, "Vishay"), disclaim any and all liability for any errors, inaccuracies or incompleteness contained in any datasheet or in any other disclosure relating to any product.

Vishay makes no warranty, representation or guarantee regarding the suitability of the products for any particular purpose or the continuing production of any product. To the maximum extent permitted by applicable law, Vishay disclaims (i) any and all liability arising out of the application or use of any product, (ii) any and all liability, including without limitation special, consequential or incidental damages, and (iii) any and all implied warranties, including warranties of fitness for particular purpose, non-infringement and merchantability.

Statements regarding the suitability of products for certain types of applications are based on Vishay's knowledge of typical requirements that are often placed on Vishay products in generic applications. Such statements are not binding statements about the suitability of products for a particular application. It is the customer's responsibility to validate that a particular product with the properties described in the product specification is suitable for use in a particular application. Parameters provided in datasheets and / or specifications may vary in different applications and performance may vary over time. All operating parameters, including typical parameters, must be validated for each customer application by the customer's technical experts. Product specifications do not expand or otherwise modify Vishay's terms and conditions of purchase, including but not limited to the warranty expressed therein.

Hyperlinks included in this datasheet may direct users to third-party websites. These links are provided as a convenience and for informational purposes only. Inclusion of these hyperlinks does not constitute an endorsement or an approval by Vishay of any of the products, services or opinions of the corporation, organization or individual associated with the third-party website. Vishay disclaims any and all liability and bears no responsibility for the accuracy, legality or content of the third-party website or for that of subsequent links.

Vishay products are not designed for use in life-saving or life-sustaining applications or any application in which the failure of the Vishay product could result in personal injury or death unless specifically qualified in writing by Vishay. Customers using or selling Vishay products not expressly indicated for use in such applications do so at their own risk. Please contact authorized Vishay personnel to obtain written terms and conditions regarding products designed for such applications.

No license, express or implied, by estoppel or otherwise, to any intellectual property rights is granted by this document or by any conduct of Vishay. Product names and markings noted herein may be trademarks of their respective owners.