

Single-Line ESD Protection in SOT-23

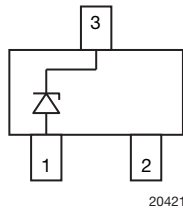

20421

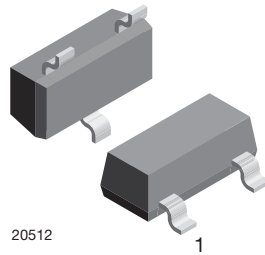

20512

1

MARKING (example only)

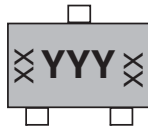

20357

YYY = type code (see table below)

XX = date code

FEATURES

- Single-line ESD protection device
- ESD immunity acc. IEC 61000-4-2
± 30 kV contact discharge
± 30 kV air discharge
- ESD capability according to AEC-Q101:
human body model: class H3B: > 8 kV
- Space saving SOT-23 package
- e3 - Sn
- AEC-Q101 qualified available
- Material categorization: for definitions of compliance please see www.vishay.com/doc?99912



DESIGN SUPPORT TOOLS AVAILABLE



ORDERING INFORMATION							
PART NUMBER (EXAMPLE)	ENVIRONMENTAL AND QUALITY CODE				PACKAGING CODE		ORDERING CODE (EXAMPLE)
	AEC-Q101 QUALIFIED	RoHS-COMPLIANT + LEAD (Pb)-FREE		TIN PLATED	3K PER 7" REEL (8 mm TAPE), 15K/BOX = MOQ	10K PER 13" REEL (8 mm TAPE), 10K/BOX = MOQ	
		STANDARD	GREEN				
GSOT05-		E		3	-08		GSOT05-E3-08
GSOT05-			G	3	-08		GSOT05-G3-08
GSOT05-	H	E		3	-08		GSOT05-HE3-08
GSOT05-	H		G	3	-08		GSOT05-HG3-08
GSOT05-		E		3		-18	GSOT05-E3-18
GSOT05-			G	3		-18	GSOT05-G3-18
GSOT05-	H	E		3		-18	GSOT05-HE3-18
GSOT05-	H		G	3		-18	GSOT05-HG3-18

PACKAGE DATA							
DEVICE NAME	PACKAGE NAME	TYPE CODE	ENVIRONMENTAL STATUS	WEIGHT	MOLDING COMPOUND FLAMMABILITY RATING	MOISTURE SENSITIVITY LEVEL	SOLDERING CONDITIONS
GSOT03	SOT-23	03	Standard	8.8 mg	UL 94 V-0	MSL level 1 (according J-STD-020)	Peak temperature max. 260 °C
		03G	Green	8.1 mg			
GSOT04	SOT-23	04	Standard	8.8 mg	UL 94 V-0	MSL level 1 (according J-STD-020)	Peak temperature max. 260 °C
		04G	Green	8.1 mg			
GSOT05	SOT-23	05	Standard	8.8 mg	UL 94 V-0	MSL level 1 (according J-STD-020)	Peak temperature max. 260 °C
		05G	Green	8.1 mg			
GSOT08	SOT-23	08	Standard	8.8 mg	UL 94 V-0	MSL level 1 (according J-STD-020)	Peak temperature max. 260 °C
		08G	Green	8.1 mg			
GSOT12	SOT-23	12	Standard	8.8 mg	UL 94 V-0	MSL level 1 (according J-STD-020)	Peak temperature max. 260 °C
		12G	Green	8.1 mg			
GSOT15	SOT-23	15	Standard	8.8 mg	UL 94 V-0	MSL level 1 (according J-STD-020)	Peak temperature max. 260 °C
		15G	Green	8.1 mg			
GSOT24	SOT-23	24	Standard	8.8 mg	UL 94 V-0	MSL level 1 (according J-STD-020)	Peak temperature max. 260 °C
		24G	Green	8.1 mg			
GSOT36	SOT-23	36	Standard	8.8 mg	UL 94 V-0	MSL level 1 (according J-STD-020)	Peak temperature max. 260 °C
		36G	Green	8.1 mg			



ABSOLUTE MAXIMUM RATINGS GSOT03				
PARAMETER	TEST CONDITIONS	SYMBOL	VALUE	UNIT
Peak pulse current	Pin 3 to 1 acc. IEC 61000-4-5, $t_p = 8/20 \mu\text{s}$; single shot	I_{PPM}	30	A
Peak pulse power	Pin 3 to 1 acc. IEC 61000-4-5, $t_p = 8/20 \mu\text{s}$; single shot	P_{PP}	369	W
ESD immunity	Contact discharge acc. IEC 61000-4-2; 10 pulses	V_{ESD}	± 30	kV
	Air discharge acc. IEC 61000-4-2; 10 pulses		± 30	kV
Operating temperature	Junction temperature	T_J	-40 to +125	$^{\circ}\text{C}$
Storage temperature		T_{STG}	-55 to +150	$^{\circ}\text{C}$

ABSOLUTE MAXIMUM RATINGS GSOT04				
PARAMETER	TEST CONDITIONS	SYMBOL	VALUE	UNIT
Peak pulse current	Pin 3 to 1 acc. IEC 61000-4-5, $t_p = 8/20 \mu\text{s}$; single shot	I_{PPM}	30	A
Peak pulse power	Pin 3 to 1 acc. IEC 61000-4-5, $t_p = 8/20 \mu\text{s}$; single shot	P_{PP}	429	W
ESD immunity	Contact discharge acc. IEC 61000-4-2; 10 pulses	V_{ESD}	± 30	kV
	Air discharge acc. IEC 61000-4-2; 10 pulses		± 30	kV
Operating temperature	Junction temperature	T_J	-40 to +125	$^{\circ}\text{C}$
Storage temperature		T_{STG}	-55 to +150	$^{\circ}\text{C}$

ABSOLUTE MAXIMUM RATINGS GSOT05				
PARAMETER	TEST CONDITIONS	SYMBOL	VALUE	UNIT
Peak pulse current	Pin 3 to 1 acc. IEC 61000-4-5, $t_p = 8/20 \mu\text{s}$; single shot	I_{PPM}	30	A
Peak pulse power	Pin 3 to 1 acc. IEC 61000-4-5, $t_p = 8/20 \mu\text{s}$; single shot	P_{PP}	480	W
ESD immunity	Contact discharge acc. IEC 61000-4-2; 10 pulses	V_{ESD}	± 30	kV
	Air discharge acc. IEC 61000-4-2; 10 pulses		± 30	kV
Operating temperature	Junction temperature	T_J	-40 to +125	$^{\circ}\text{C}$
Storage temperature		T_{STG}	-55 to +150	$^{\circ}\text{C}$

ABSOLUTE MAXIMUM RATINGS GSOT08				
PARAMETER	TEST CONDITIONS	SYMBOL	VALUE	UNIT
Peak pulse current	Pin 3 to 1 acc. IEC 61000-4-5, $t_p = 8/20 \mu\text{s}$; single shot	I_{PPM}	18	A
Peak pulse power	Pin 3 to 1 acc. IEC 61000-4-5, $t_p = 8/20 \mu\text{s}$; single shot	P_{PP}	345	W
ESD immunity	Contact discharge acc. IEC 61000-4-2; 10 pulses	V_{ESD}	± 30	kV
	Air discharge acc. IEC 61000-4-2; 10 pulses		± 30	kV
Operating temperature	Junction temperature	T_J	-40 to +125	$^{\circ}\text{C}$
Storage temperature		T_{STG}	-55 to +150	$^{\circ}\text{C}$



ABSOLUTE MAXIMUM RATINGS GSOT12				
PARAMETER	TEST CONDITIONS	SYMBOL	VALUE	UNIT
Peak pulse current	Pin 3 to 1 acc. IEC 61000-4-5, $t_p = 8/20 \mu\text{s}$; single shot	I_{PPM}	12	A
Peak pulse power	Pin 3 to 1 acc. IEC 61000-4-5, $t_p = 8/20 \mu\text{s}$; single shot	P_{PP}	312	W
ESD immunity	Contact discharge acc. IEC 61000-4-2; 10 pulses	V_{ESD}	± 30	kV
	Air discharge acc. IEC 61000-4-2; 10 pulses		± 30	kV
Operating temperature	Junction temperature	T_J	-40 to +125	$^{\circ}\text{C}$
Storage temperature		T_{STG}	-55 to +150	$^{\circ}\text{C}$

ABSOLUTE MAXIMUM RATINGS GSOT15				
PARAMETER	TEST CONDITIONS	SYMBOL	VALUE	UNIT
Peak pulse current	Pin 3 to 1 acc. IEC 61000-4-5, $t_p = 8/20 \mu\text{s}$; single shot	I_{PPM}	8	A
Peak pulse power	Pin 3 to 1 acc. IEC 61000-4-5, $t_p = 8/20 \mu\text{s}$; single shot	P_{PP}	230	W
ESD immunity	Contact discharge acc. IEC 61000-4-2; 10 pulses	V_{ESD}	± 30	kV
	Air discharge acc. IEC 61000-4-2; 10 pulses		± 30	kV
Operating temperature	Junction temperature	T_J	-40 to +125	$^{\circ}\text{C}$
Storage temperature		T_{STG}	-55 to +150	$^{\circ}\text{C}$

ABSOLUTE MAXIMUM RATINGS GSOT24				
PARAMETER	TEST CONDITIONS	SYMBOL	VALUE	UNIT
Peak pulse current	Pin 3 to 1 acc. IEC 61000-4-5, $t_p = 8/20 \mu\text{s}$; single shot	I_{PPM}	5	A
Peak pulse power	Pin 3 to 1 acc. IEC 61000-4-5, $t_p = 8/20 \mu\text{s}$; single shot	P_{PP}	235	W
ESD immunity	Contact discharge acc. IEC 61000-4-2; 10 pulses	V_{ESD}	± 30	kV
	Air discharge acc. IEC 61000-4-2; 10 pulses		± 30	kV
Operating temperature	Junction temperature	T_J	-40 to +125	$^{\circ}\text{C}$
Storage temperature		T_{STG}	-55 to +150	$^{\circ}\text{C}$

ABSOLUTE MAXIMUM RATINGS GSOT36				
PARAMETER	TEST CONDITIONS	SYMBOL	VALUE	UNIT
Peak pulse current	Pin 3 to 1 acc. IEC 61000-4-5, $t_p = 8/20 \mu\text{s}$; single shot	I_{PPM}	3.5	A
Peak pulse power	Pin 3 to 1 acc. IEC 61000-4-5, $t_p = 8/20 \mu\text{s}$; single shot	P_{PP}	248	W
ESD immunity	Contact discharge acc. IEC 61000-4-2; 10 pulses	V_{ESD}	± 30	kV
	Air discharge acc. IEC 61000-4-2; 10 pulses		± 30	kV
Operating temperature	Junction temperature	T_J	-40 to +125	$^{\circ}\text{C}$
Storage temperature		T_{STG}	-55 to +150	$^{\circ}\text{C}$

BiAs-MODE (1-line Bidirectional Asymmetrical protection mode)

With the GSOTxx one signal- or data-lines (L1) can be protected against voltage transients. With pin 1 connected to ground and pin 3 connected to a signal- or data-line which has to be protected. As long as the voltage level on the data- or signal-line is between 0 V (ground level) and the specified maximum reverse working voltage (V_{RWM}) the protection diode between pin 1 and pin 3 offers a high isolation to the ground line. The protection device behaves like an open switch.

As soon as any positive transient voltage signal exceeds the breakdown voltage level of the protection diode, the diode becomes conductive and shorts the transient current to ground. Now the protection device behaves like a closed switch. The clamping voltage (V_C) is defined by the breakdown voltage (V_{BR}) level plus the voltage drop at the series impedance (resistance and inductance) of the protection diode.

Any negative transient signal will be clamped accordingly. The negative transient current is flowing in the forward direction through the protection diode. The low forward voltage (V_F) clamps the negative transient close to the ground level.

Due to the different clamping levels in forward and reverse direction the GSOTxx clamping behavior is Bidirectional and Asymmetrical (BiAs).

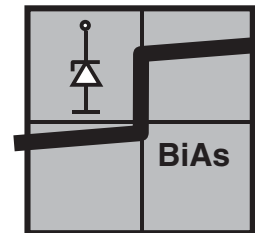
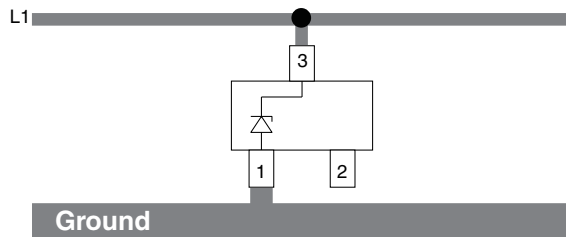

20422

ELECTRICAL CHARACTERISTICS GSOT03 ($T_{amb} = 25\text{ }^{\circ}\text{C}$ unless otherwise specified) between pin 3 and pin 1						
PARAMETER	TEST CONDITIONS/REMARKS	SYMBOL	MIN.	TYP.	MAX.	UNIT
Protection paths	Number of lines which can be protected	$N_{channel}$	-	-	1	lines
Reverse stand-off voltage	Max. reverse working voltage	V_{RWM}	-	-	3.3	V
Reverse voltage	at $I_R = 100\text{ }\mu\text{A}$	V_R	3.3	-	-	V
Reverse current	at $V_R = 3.3\text{ V}$	I_R	-	-	100	μA
Reverse breakdown voltage	at $I_R = 1\text{ mA}$	V_{BR}	4	4.6	5.5	V
Reverse clamping voltage	at $I_{PP} = 1\text{ A}$	V_C	-	5.7	7.5	V
	at $I_{PP} = I_{PPM} = 30\text{ A}$		-	10	12.3	V
Forward clamping voltage	at $I_{PP} = 1\text{ A}$	V_F	-	1	1.2	V
	at $I_{PP} = I_{PPM} = 30\text{ A}$		-	4.5	-	V
Capacitance	at $V_R = 0\text{ V}$; $f = 1\text{ MHz}$	C_D	-	420	600	pF
	at $V_R = 1.6\text{ V}$; $f = 1\text{ MHz}$		-	260	-	pF

ELECTRICAL CHARACTERISTICS GSOT04 ($T_{amb} = 25\text{ }^{\circ}\text{C}$ unless otherwise specified) between pin 3 and pin 1						
PARAMETER	TEST CONDITIONS/REMARKS	SYMBOL	MIN.	TYP.	MAX.	UNIT
Protection paths	Number of lines which can be protected	$N_{channel}$	-	-	1	lines
Reverse stand-off voltage	Max. reverse working voltage	V_{RWM}	-	-	4	V
Reverse voltage	at $I_R = 20\text{ }\mu\text{A}$	V_R	4	-	-	V
Reverse current	at $V_R = 4\text{ V}$	I_R	-	-	20	μA
Reverse breakdown voltage	at $I_R = 1\text{ mA}$	V_{BR}	5	6.1	7	V
Reverse clamping voltage	at $I_{PP} = 1\text{ A}$	V_C	-	7.5	9	V
	at $I_{PP} = I_{PPM} = 30\text{ A}$		-	11.2	14.3	V
Forward clamping voltage	at $I_{PP} = 1\text{ A}$	V_F	-	1	1.2	V
	at $I_{PP} = I_{PPM} = 30\text{ A}$		-	4.5	-	V
Capacitance	at $V_R = 0\text{ V}$; $f = 1\text{ MHz}$	C_D	-	310	450	pF
	at $V_R = 2\text{ V}$; $f = 1\text{ MHz}$		-	200	-	pF



ELECTRICAL CHARACTERISTICS GSOT05 ($T_{amb} = 25\text{ }^{\circ}\text{C}$ unless otherwise specified) between pin 3 and pin 1						
PARAMETER	TEST CONDITIONS/REMARKS	SYMBOL	MIN.	TYP.	MAX.	UNIT
Protection paths	Number of lines which can be protected	$N_{channel}$	-	-	1	lines
Reverse stand-off voltage	Max. reverse working voltage	V_{RWM}	-	-	5	V
Reverse voltage	at $I_R = 10\text{ }\mu\text{A}$	V_R	5	-	-	V
Reverse current	at $V_R = 5\text{ V}$	I_R	-	-	10	μA
Reverse breakdown voltage	at $I_R = 1\text{ mA}$	V_{BR}	6	6.8	8	V
Reverse clamping voltage	at $I_{PP} = 1\text{ A}$	V_C	-	7	8.7	V
	at $I_{PP} = I_{PPM} = 30\text{ A}$		-	12	16	V
Forward clamping voltage	at $I_{PP} = 1\text{ A}$	V_F	-	1	1.2	V
	at $I_{PP} = I_{PPM} = 30\text{ A}$		-	4.5	-	V
Capacitance	at $V_R = 0\text{ V}$; $f = 1\text{ MHz}$	C_D	-	260	350	pF
	at $V_R = 2.5\text{ V}$; $f = 1\text{ MHz}$		-	150	-	pF

ELECTRICAL CHARACTERISTICS GSOT08 ($T_{amb} = 25\text{ }^{\circ}\text{C}$ unless otherwise specified) between pin 3 and pin 1						
PARAMETER	TEST CONDITIONS/REMARKS	SYMBOL	MIN.	TYP.	MAX.	UNIT
Protection paths	Number of lines which can be protected	$N_{channel}$	-	-	1	lines
Reverse stand-off voltage	Max. reverse working voltage	V_{RWM}	-	-	8	V
Reverse voltage	at $I_R = 5\text{ }\mu\text{A}$	V_R	8	-	-	V
Reverse current	at $V_R = 8\text{ V}$	I_R	-	-	5	μA
Reverse breakdown voltage	at $I_R = 1\text{ mA}$	V_{BR}	9	10	11	V
Reverse clamping voltage	at $I_{PP} = 1\text{ A}$	V_C	-	10.7	13	V
	at $I_{PP} = I_{PPM} = 18\text{ A}$		-	15.2	19.2	V
Forward clamping voltage	at $I_{PP} = 1\text{ A}$	V_F	-	1	1.2	V
	at $I_{PP} = I_{PPM} = 18\text{ A}$		-	3	-	V
Capacitance	at $V_R = 0\text{ V}$; $f = 1\text{ MHz}$	C_D	-	160	250	pF
	at $V_R = 4\text{ V}$; $f = 1\text{ MHz}$		-	80	-	pF

ELECTRICAL CHARACTERISTICS GSOT12 ($T_{amb} = 25\text{ }^{\circ}\text{C}$ unless otherwise specified) between pin 3 and pin 1						
PARAMETER	TEST CONDITIONS/REMARKS	SYMBOL	MIN.	TYP.	MAX.	UNIT
Protection paths	Number of lines which can be protected	$N_{channel}$	-	-	1	lines
Reverse stand-off voltage	Max. reverse working voltage	V_{RWM}	-	-	12	V
Reverse voltage	at $I_R = 1\text{ }\mu\text{A}$	V_R	12	-	-	V
Reverse current	at $V_R = 12\text{ V}$	I_R	-	-	1	μA
Reverse breakdown voltage	at $I_R = 1\text{ mA}$	V_{BR}	13.5	15	16.5	V
Reverse clamping voltage	at $I_{PP} = 1\text{ A}$	V_C	-	15.4	18.7	V
	at $I_{PP} = I_{PPM} = 12\text{ A}$		-	21.2	26	V
Forward clamping voltage	at $I_{PP} = 1\text{ A}$	V_F	-	1	1.2	V
	at $I_{PP} = I_{PPM} = 12\text{ A}$		-	2.2	-	V
Capacitance	at $V_R = 0\text{ V}$; $f = 1\text{ MHz}$	C_D	-	115	150	pF
	at $V_R = 6\text{ V}$; $f = 1\text{ MHz}$		-	50	-	pF



ELECTRICAL CHARACTERISTICS GSOT15 ($T_{amb} = 25\text{ }^{\circ}\text{C}$ unless otherwise specified) between pin 3 and pin 1						
PARAMETER	TEST CONDITIONS/REMARKS	SYMBOL	MIN.	TYP.	MAX.	UNIT
Protection paths	Number of lines which can be protected	$N_{channel}$	-	-	1	lines
Reverse stand-off voltage	Max. reverse working voltage	V_{RWM}	-	-	15	V
Reverse voltage	at $I_R = 1\text{ }\mu\text{A}$	V_R	15	-	-	V
Reverse current	at $V_R = 15\text{ V}$	I_R	-	-	1	μA
Reverse breakdown voltage	at $I_R = 1\text{ mA}$	V_{BR}	16.5	18	20	V
Reverse clamping voltage	at $I_{PP} = 1\text{ A}$	V_C	-	19.4	23.5	V
	at $I_{PP} = I_{PPM} = 8\text{ A}$		-	24.8	28.8	V
Forward clamping voltage	at $I_{PP} = 1\text{ A}$	V_F	-	1	1.2	V
	at $I_{PP} = I_{PPM} = 8\text{ A}$		-	1.8	-	V
Capacitance	at $V_R = 0\text{ V}$; $f = 1\text{ MHz}$	C_D	-	90	120	pF
	at $V_R = 7.5\text{ V}$; $f = 1\text{ MHz}$		-	35	-	pF

ELECTRICAL CHARACTERISTICS GSOT24 ($T_{amb} = 25\text{ }^{\circ}\text{C}$ unless otherwise specified) between pin 3 and pin 1						
PARAMETER	TEST CONDITIONS/REMARKS	SYMBOL	MIN.	TYP.	MAX.	UNIT
Protection paths	Number of lines which can be protected	$N_{channel}$	-	-	1	lines
Reverse stand-off voltage	Max. reverse working voltage	V_{RWM}	-	-	24	V
Reverse voltage	at $I_R = 1\text{ }\mu\text{A}$	V_R	24	-	-	V
Reverse current	at $V_R = 24\text{ V}$	I_R	-	-	1	μA
Reverse breakdown voltage	at $I_R = 1\text{ mA}$	V_{BR}	27	30	33	V
Reverse clamping voltage	at $I_{PP} = 1\text{ A}$	V_C	-	34	41	V
	at $I_{PP} = I_{PPM} = 5\text{ A}$		-	41	47	V
Forward clamping voltage	at $I_{PP} = 1\text{ A}$	V_F	-	1	1.2	V
	at $I_{PP} = I_{PPM} = 5\text{ A}$		-	1.4	-	V
Capacitance	at $V_R = 0\text{ V}$; $f = 1\text{ MHz}$	C_D	-	65	80	pF
	at $V_R = 12\text{ V}$; $f = 1\text{ MHz}$		-	20	-	pF

ELECTRICAL CHARACTERISTICS GSOT36 ($T_{amb} = 25\text{ }^{\circ}\text{C}$ unless otherwise specified) between pin 3 and pin 1						
PARAMETER	TEST CONDITIONS/REMARKS	SYMBOL	MIN.	TYP.	MAX.	UNIT
Protection paths	Number of lines which can be protected	$N_{channel}$	-	-	1	lines
Reverse stand-off voltage	Max. reverse working voltage	V_{RWM}	-	-	36	V
Reverse voltage	at $I_R = 1\text{ }\mu\text{A}$	V_R	36	-	-	V
Reverse current	at $V_R = 36\text{ V}$	I_R	-	-	1	μA
Reverse breakdown voltage	at $I_R = 1\text{ mA}$	V_{BR}	39	43	47	V
Reverse clamping voltage	at $I_{PP} = 1\text{ A}$	V_C	-	49	60	V
	at $I_{PP} = I_{PPM} = 3.5\text{ A}$		-	59	71	V
Forward clamping voltage	at $I_{PP} = 1\text{ A}$	V_F	-	1	1.2	V
	at $I_{PP} = I_{PPM} = 3.5\text{ A}$		-	1.3	-	V
Capacitance	at $V_R = 0\text{ V}$; $f = 1\text{ MHz}$	C_D	-	52	65	pF
	at $V_R = 18\text{ V}$; $f = 1\text{ MHz}$		-	12	-	pF

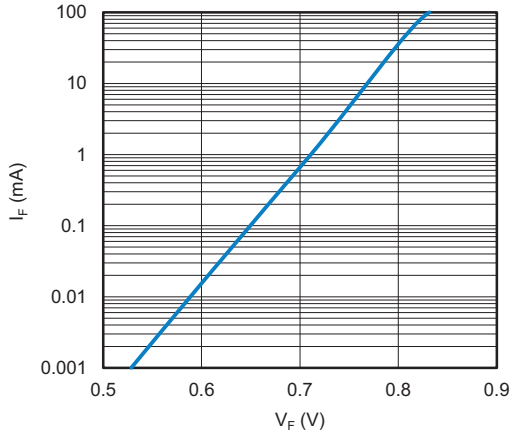

Fig. 1 - Typical Forward Current I_F vs. Forward Voltage V_F

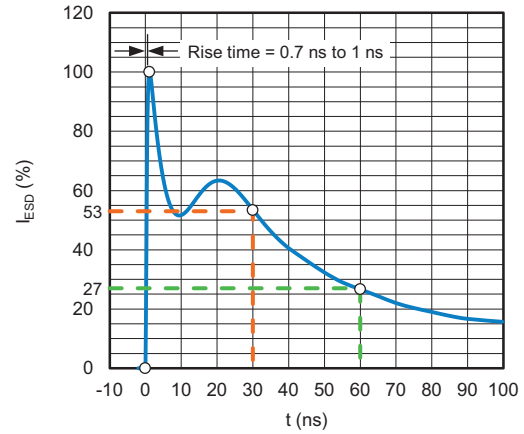

Fig. 4 - ESD Discharge Current Waveform According to IEC 61000-4-2 (330 Ω / 150 pF)

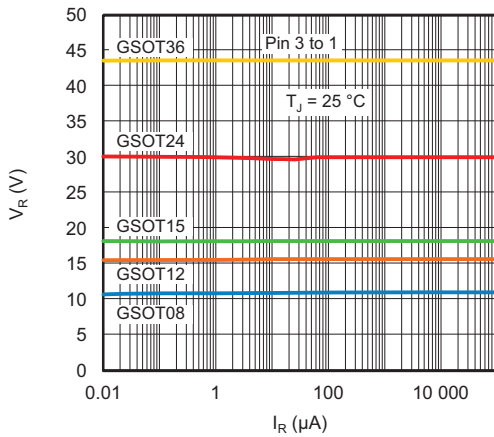

Fig. 2 - Typical Reverse Voltage V_R vs. Reverse Current I_R

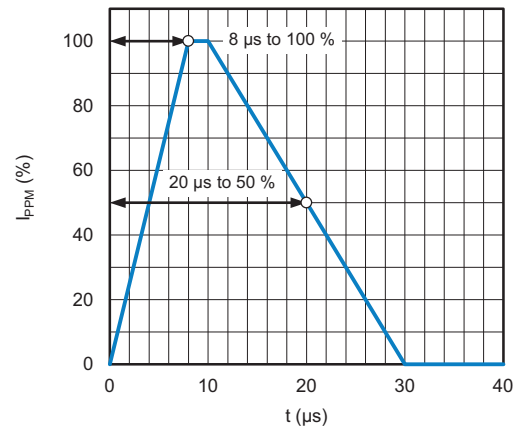

Fig. 5 - 8/20 μ s Peak Pulse Current Waveform According to IEC 61000-4-5

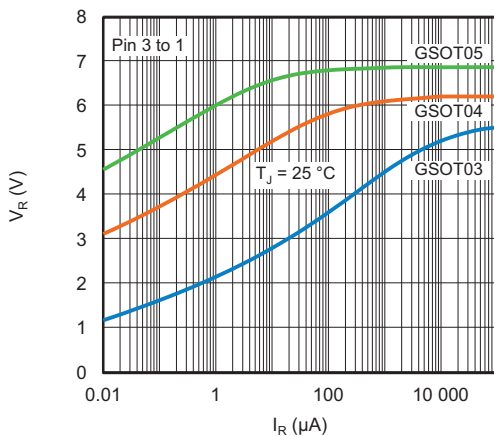

Fig. 3 - Typical Reverse Voltage V_R vs. Reverse Current I_R

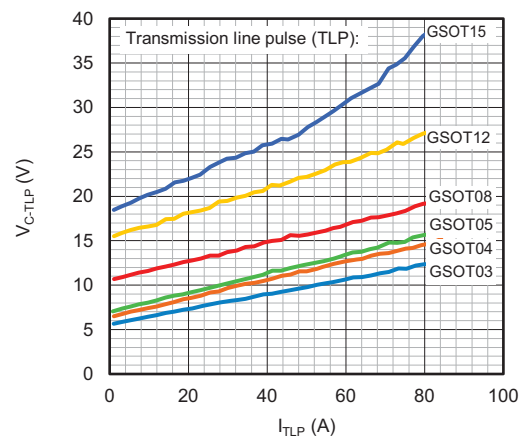

Fig. 6 - Typical Clamping Voltage vs. Peak Pulse Current

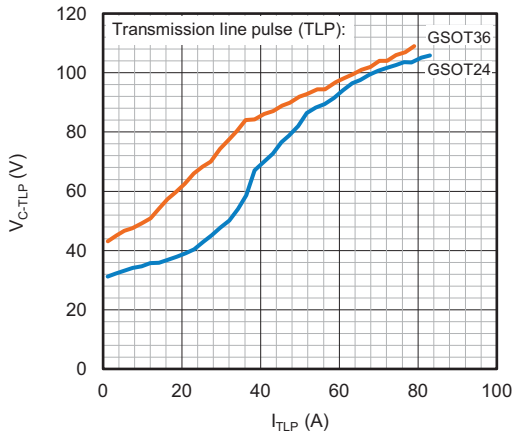

Fig. 7 - Typical Clamping Voltage vs. Peak Pulse Current

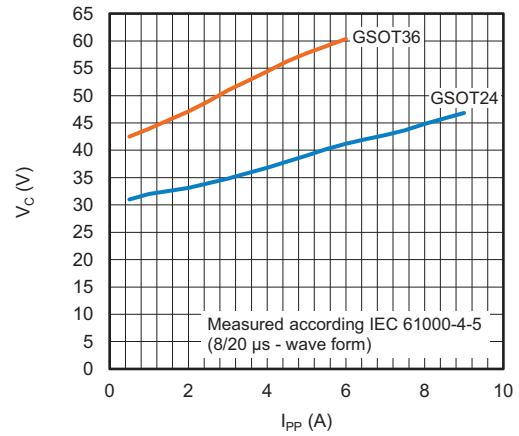

Fig. 9 - Typical Peak Clamping Voltage vs. Peak Pulse Current

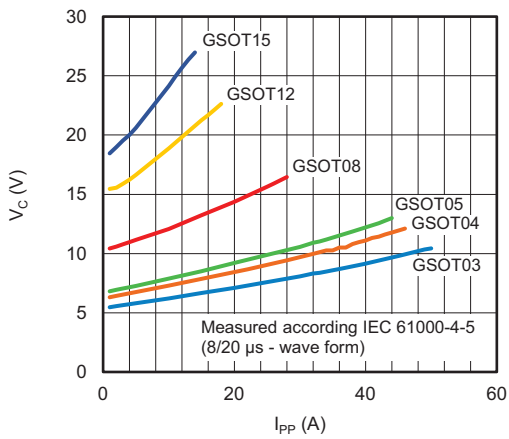

Fig. 8 - Typical Peak Clamping Voltage vs. Peak Pulse Current

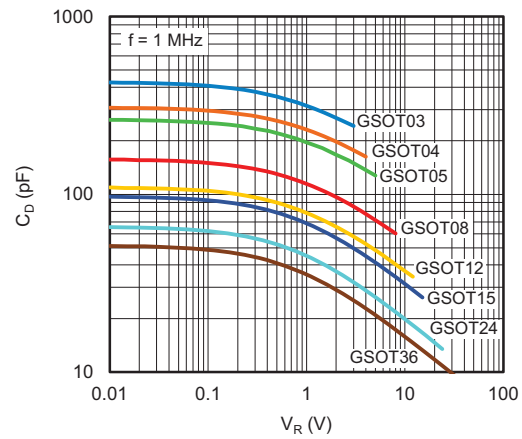
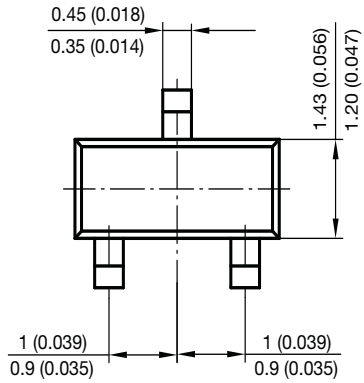
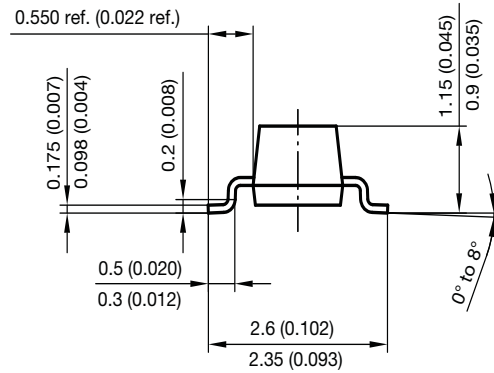
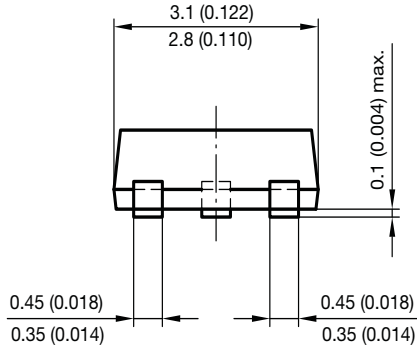

Fig. 10 - Typical Capacitance vs. Reverse Voltage



PACKAGE DIMENSIONS in millimeters (inches): **SOT-23**



Foot print recommendation:

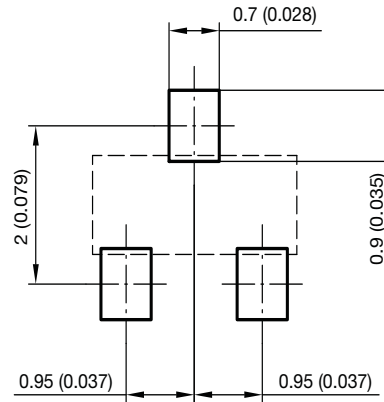

Document no.: 6.541-5014.01-4
Rev. 8 - Date: 23. Sep. 2009
17418

Orientation in carrier tape
SOT-23
S8-V-3929.01-006 (4)
04.02.2010
22607

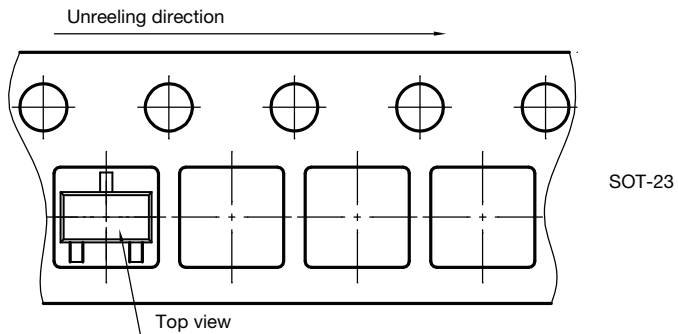



Disclaimer

ALL PRODUCT, PRODUCT SPECIFICATIONS AND DATA ARE SUBJECT TO CHANGE WITHOUT NOTICE TO IMPROVE RELIABILITY, FUNCTION OR DESIGN OR OTHERWISE.

Vishay Intertechnology, Inc., its affiliates, agents, and employees, and all persons acting on its or their behalf (collectively, "Vishay"), disclaim any and all liability for any errors, inaccuracies or incompleteness contained in any datasheet or in any other disclosure relating to any product.

Vishay makes no warranty, representation or guarantee regarding the suitability of the products for any particular purpose or the continuing production of any product. To the maximum extent permitted by applicable law, Vishay disclaims (i) any and all liability arising out of the application or use of any product, (ii) any and all liability, including without limitation special, consequential or incidental damages, and (iii) any and all implied warranties, including warranties of fitness for particular purpose, non-infringement and merchantability.

Statements regarding the suitability of products for certain types of applications are based on Vishay's knowledge of typical requirements that are often placed on Vishay products in generic applications. Such statements are not binding statements about the suitability of products for a particular application. It is the customer's responsibility to validate that a particular product with the properties described in the product specification is suitable for use in a particular application. Parameters provided in datasheets and / or specifications may vary in different applications and performance may vary over time. All operating parameters, including typical parameters, must be validated for each customer application by the customer's technical experts. Product specifications do not expand or otherwise modify Vishay's terms and conditions of purchase, including but not limited to the warranty expressed therein.

Hyperlinks included in this datasheet may direct users to third-party websites. These links are provided as a convenience and for informational purposes only. Inclusion of these hyperlinks does not constitute an endorsement or an approval by Vishay of any of the products, services or opinions of the corporation, organization or individual associated with the third-party website. Vishay disclaims any and all liability and bears no responsibility for the accuracy, legality or content of the third-party website or for that of subsequent links.

Vishay products are not designed for use in life-saving or life-sustaining applications or any application in which the failure of the Vishay product could result in personal injury or death unless specifically qualified in writing by Vishay. Customers using or selling Vishay products not expressly indicated for use in such applications do so at their own risk. Please contact authorized Vishay personnel to obtain written terms and conditions regarding products designed for such applications.

No license, express or implied, by estoppel or otherwise, to any intellectual property rights is granted by this document or by any conduct of Vishay. Product names and markings noted herein may be trademarks of their respective owners.