

# MMQA, SZMMQA Quad Common Anode Series

## ESD Protection Diode

### SC-74 Quad Monolithic Common Anode

This quad monolithic silicon voltage suppressor is designed for applications requiring transient overvoltage protection capability. It is intended for use in voltage and ESD sensitive equipment such as computers, printers, business machines, communication systems, medical equipment, and other applications. Its quad junction common anode design protects four separate lines using only one package. These devices are ideal for situations where board space is at a premium.

#### Features

- SC-74 Package Allows Four Separate Unidirectional Configurations
- Peak Power – Min. 24 W @ 1.0 ms (Unidirectional), per Figure 5 Waveform
- Peak Power – Min. 150 W @ 20  $\mu$ s (Unidirectional), per Figure 6 Waveform
- Maximum Clamping Voltage @ Peak Pulse Current
- Low Leakage < 2.0  $\mu$ A
- ESD Rating of Class 3B (exceeding 16 kV) per the Human Body Model
- SZ Prefix for Automotive and Other Applications Requiring Unique Site and Control Change Requirements; AEC-Q101 Qualified and PPAP Capable
- These Devices are Pb-Free and are RoHS Compliant\*



ON Semiconductor®

[www.onsemi.com](http://www.onsemi.com)

### SC-74 QUAD SURGE PROTECTION 24 WATTS PEAK POWER 5.6 – 33 VOLTS



SC-74  
CASE 318F  
STYLE 1

#### PIN ASSIGNMENT

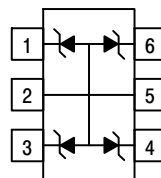

PIN 1. CATHODE  
2. ANODE  
3. CATHODE  
4. CATHODE  
5. ANODE  
6. CATHODE

#### MARKING DIAGRAM

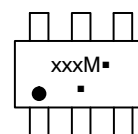

xxx = Specific Device Code  
M = Date Code  
▪ = Pb-Free Package

(Note: Microdot may be in either location)

#### DEVICE MARKING & ORDERING INFORMATION

See specific marking and ordering information in the device marking and ordering information table on page 6 of this data sheet.

\*For additional information on our Pb-Free strategy and soldering details, please download the ON Semiconductor Soldering and Mounting Techniques Reference Manual, SOLDERRM/D.

# MMQA, SZMMQA Quad Common Anode Series

## THERMAL CHARACTERISTICS ( $T_A = 25^\circ\text{C}$ Unless Otherwise Noted)

Characteristic	Symbol	Value	Unit
Peak Power Dissipation @ 1.0 ms (Note 1) @ $T_A \leq 25^\circ\text{C}$	$P_{pk}$	24	W
Peak Power Dissipation @ 20 $\mu\text{s}$ (Note 2) @ $T_A \leq 25^\circ\text{C}$	$P_{pk}$	150	W
Total Power Dissipation on FR-5 Board (Note 3) @ $T_A = 25^\circ\text{C}$	$P_D$	225 1.8	MW mW/ $^\circ\text{C}$
Thermal Resistance from Junction-to-Ambient	$R_{\theta JA}$	556	$^\circ\text{C}/\text{W}$
Total Power Dissipation on Alumina Substrate (Note 4) @ $T_A = 25^\circ\text{C}$ Derate above $25^\circ\text{C}$	$P_D$	300 2.4	MW mW/ $^\circ\text{C}$
Thermal Resistance from Junction-to-Ambient	$R_{\theta JA}$	417	$^\circ\text{C}/\text{W}$
Junction and Storage Temperature Range	$T_J, T_{stg}$	-55 to +150	$^\circ\text{C}$
Lead Solder Temperature – Maximum (10 Second Duration)	$T_L$	260	$^\circ\text{C}$

1. Non-repetitive current pulse per Figure 5 and derate above  $T_A = 25^\circ\text{C}$  per Figure 4.
2. Non-repetitive current pulse per Figure 6 and derate above  $T_A = 25^\circ\text{C}$  per Figure 4.
3. FR-5 = 1.0 x 0.75 x 0.62 in.
4. Alumina = 0.4 x 0.3 x 0.024 in., 99.5% alumina

## ELECTRICAL CHARACTERISTICS ( $T_A = 25^\circ\text{C}$ Unless Otherwise Noted)

### UNIDIRECTIONAL

(Circuit tied to pins 1, 2, and 5; Pins 2, 3, and 5; Pins 2, 4, and 5; or Pins 2, 5, and 6) ( $V_F = 0.9\text{ V Max @ } I_F = 10\text{ mA}$ )

Device (Note 5)	Breakdown Voltage			Max Reverse Leakage Current			Max Zener Impedance (Note 7)	Max Reverse Surge Current	Max Reverse Voltage @ $I_{RSM}$ (Note 8) (Clamping Voltage)	Maximum Temperature Coefficient of $V_Z$	Capacitance @ 0 Volt Bias, 1 MHz	
	$V_{ZT}$ (Note 6) (V)			@ $I_{ZT}$	$I_R$	$V_R$					Min	Max
MMQA5V6T1G	5.32	5.6	5.88	1.0	2000	3.0	400	3.0	8.0	1.26	-	-
MMQA6V2T1G/T3G	5.89	6.2	6.51	1.0	700	4.0	300	2.66	9.0	10.6	-	-
MMQA6V8T1G	6.46	6.8	7.14	1.0	500	4.3	300	2.45	9.8	10.9	100	250
MMQA12VT1G	11.4	12	12.6	1.0	75	9.1	80	1.39	17.3	14	-	-
MMQA13VT1G	12.4	13	13.7	1.0	75	9.8	80	1.29	18.6	15	-	-
MMQA15VT1G	14.3	15	15.8	1.0	75	11	80	1.1	21.7	16	-	-
MMQA18VT1G	17.1	18	18.9	1.0	75	14	80	0.923	26	19	-	-
MMQA20VT1G/T3G	19	20	21	1.0	75	15	80	0.84	28.6	20.1	-	-
MMQA22VT1G	20.9	22	23.1	1.0	75	17	80	0.758	31.7	22	-	-
MMQA24VT1G	22.8	24	25.2	1.0	75	18	100	0.694	34.6	25	-	-
MMQA27VT1G	25.7	27	28.4	1.0	75	21	125	0.615	39	28	-	-
MMQA33VT1G	31.4	33	34.7	1.0	75	25	200	0.504	48.6	37	-	-

5. Includes SZ-prefix devices where applicable.
6.  $V_Z$  measured at pulse test current  $I_T$  at an ambient temperature of  $25^\circ\text{C}$ .
7.  $Z_{ZT}$  is measured by dividing the AC voltage drop across the device by the AC current supplied. The specified limits are  $I_{Z(AC)} = 0.1 I_{Z(DC)}$ , with AC frequency = 1 kHz.
8. Surge current waveform per Figure 5 and derate per Figure 4.

# MMQA, SZMMQA Quad Common Anode Series

## TYPICAL CHARACTERISTICS

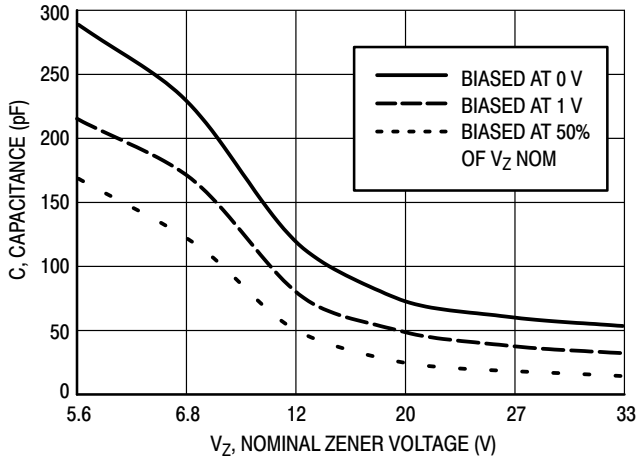

Figure 1. Typical Capacitance

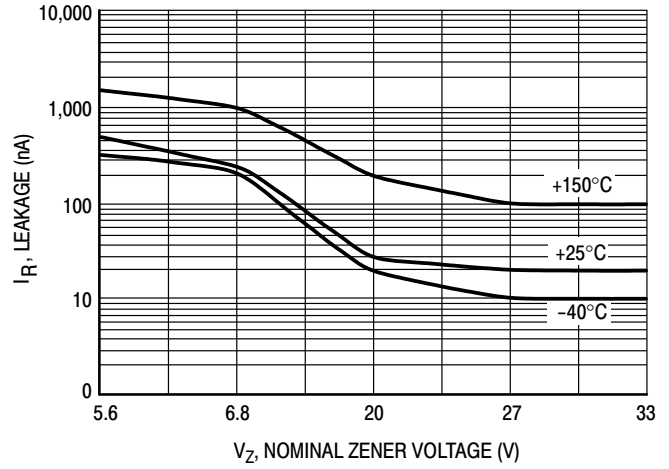

Figure 2. Typical Leakage Current

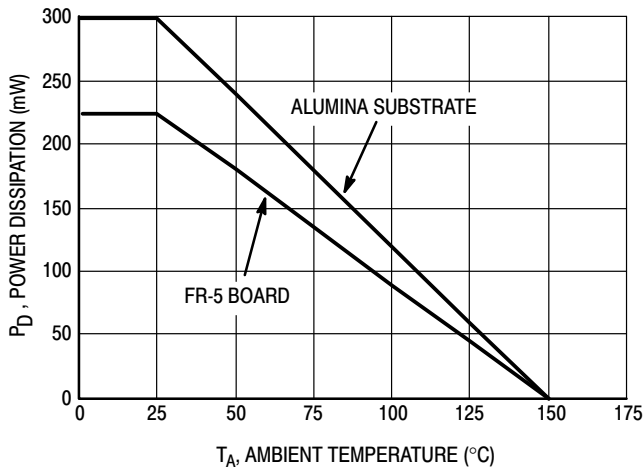

Figure 3. Steady State Power Derating Curve

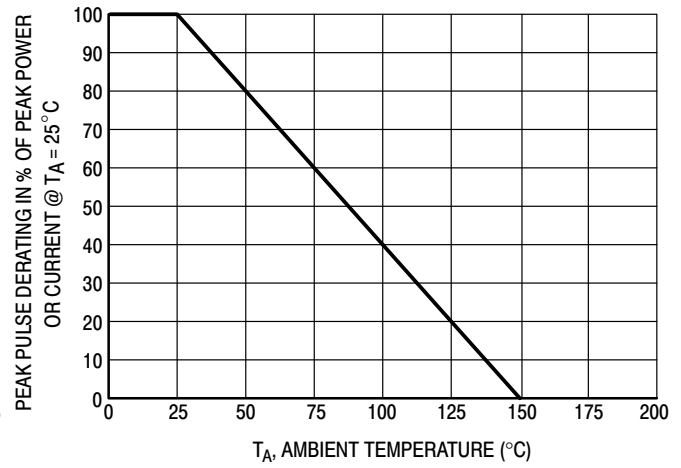

Figure 4. Pulse Derating Curve

# MMQA, SZMMQA Quad Common Anode Series

## TYPICAL CHARACTERISTICS

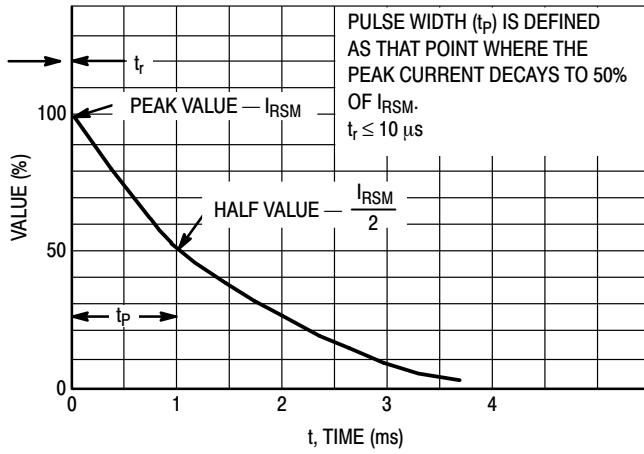

Figure 5.  $10 \times 1000 \mu s$  Pulse Waveform

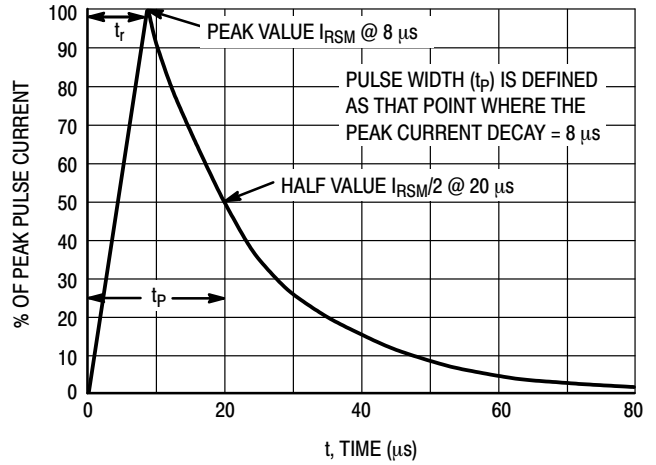

Figure 6.  $8 \times 20 \mu s$  Pulse Waveform

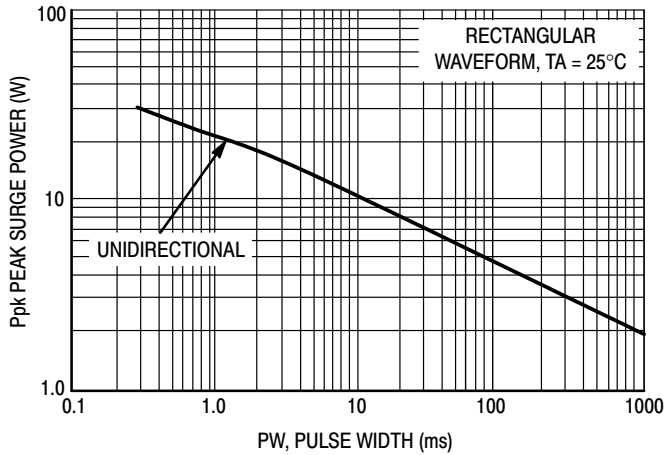

Figure 7. Maximum Non-Repetitive Surge Power,  $P_{pk}$  versus PW

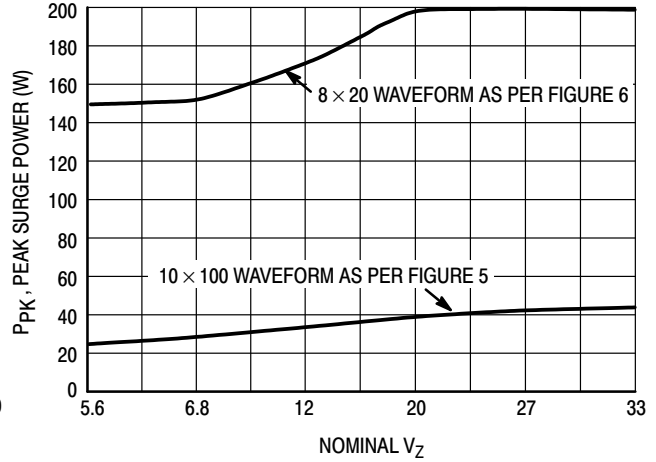

Figure 8. Typical Maximum Non-Repetitive Surge Power,  $P_{pk}$  versus  $V_Z$

Power is defined as  $V_{RSM} \times I_Z(pk)$  where  $V_{RSM}$  is the clamping voltage at  $I_Z(pk)$ .

# MMQA, SZMMQA Quad Common Anode Series

## TYPICAL COMMON ANODE APPLICATIONS

A quad junction common anode design in a SC-74 package protects four separate lines using only one package. This adds flexibility and creativity to PCB design especially

when board space is at a premium. A simplified example of MMQA/SZMMQA Series Device applications is illustrated below.

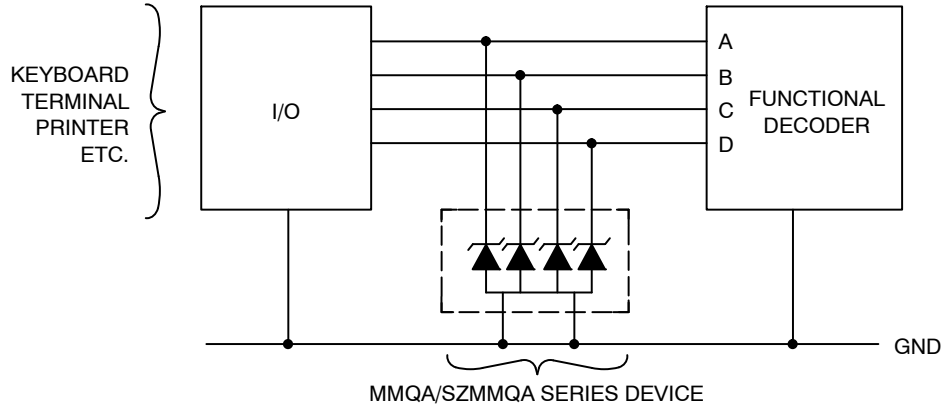

Figure 9. Computer Interface Protection

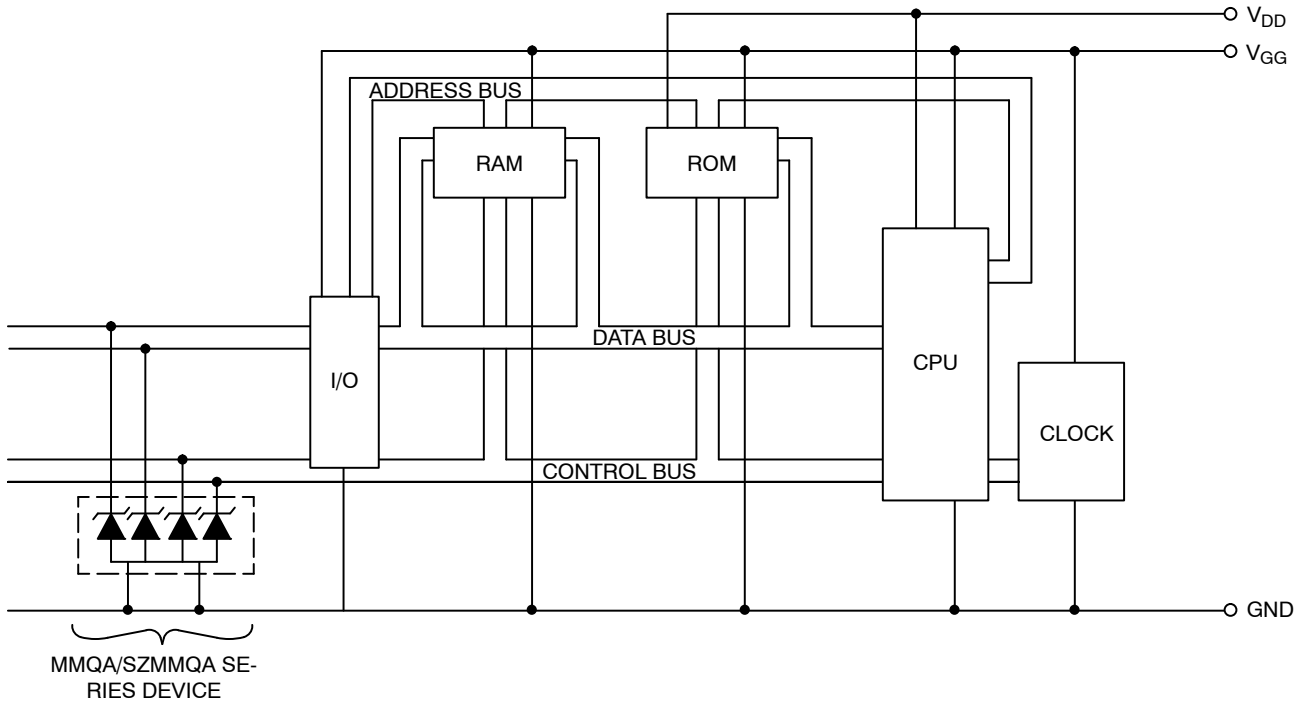

Figure 10. Microprocessor Protection

## MMQA, SZMMQA Quad Common Anode Series

### DEVICE MARKING AND ORDERING INFORMATION

Device*	Device Marking	Package	Shipping
MMQA5V6T1G	5A6	SC-74 (Pb-Free)	3,000/Tape & Reel
MMQA6V2T1G	6A2		3,000/Tape & Reel
MMQA6V2T3G	6A2		10,000/Tape & Reel
MMQA6V8T1G	6A8		3,000/Tape & Reel
MMQA12VT1G	12A		3,000/Tape & Reel
MMQA13VT1G	13A		3,000/Tape & Reel
MMQA15VT1G	15A		3,000/Tape & Reel
MMQA18VT1G	18A		3,000/Tape & Reel
MMQA20VT1G	20A		3,000/Tape & Reel
MMQA20VT3G	20A		10,000/Tape & Reel
MMQA22VT1G	22A		3,000/Tape & Reel
MMQA24VT1G	24A		3,000/Tape & Reel
MMQA27VT1G	27A		3,000/Tape & Reel
MMQA27VT3G	27A		10,000/Tape & Reel
MMQA33VT1G	33A		3,000/Tape & Reel

†For information on tape and reel specifications, including part orientation and tape sizes, please refer to our Tape and Reel Packaging Specification Brochure, BRD8011/D.

\*Include S SZ-prefix devices where applicable.

#### Mechanical Characteristics:

**CASE:** Void-free, Transfer-molded, Thermosetting Plastic Case.

**FINISH:** Corrosion resistant finish, easily solderable.

Package designed for optimal automated board assembly.

Small package size for high density applications.

Available in 8 mm Tape and Reel.

Use the Device Number to order the 7 inch/3,000 unit reel.

Replace the "T1" with "T3" in the Device Number to order the 13 inch/10,000 unit reel.



SCALE 2:1

SC-74  
CASE 318F  
ISSUE P

DATE 07 OCT 2021

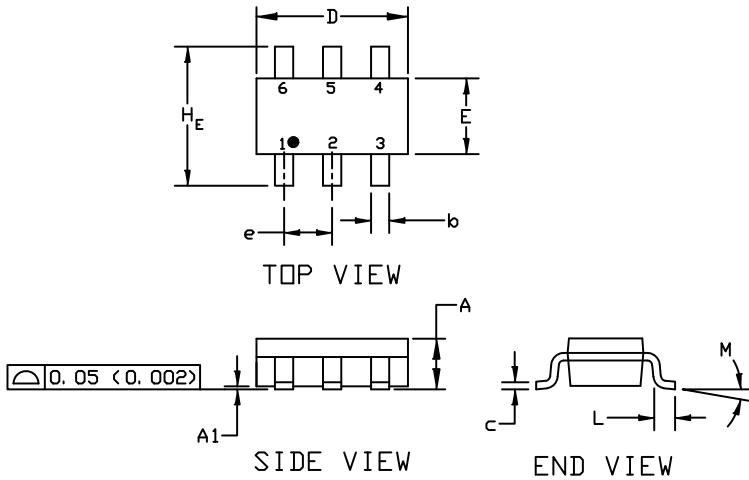

GENERIC  
MARKING DIAGRAM\*

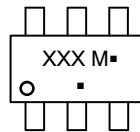

XXX = Specific Device Code  
M = Date Code  
▪ = Pb-Free Package

(Note: Microdot may be in either location)

\*This information is generic. Please refer to device data sheet for actual part marking. Pb-Free indicator, "G" or microdot "▪", may or may not be present. Some products may not follow the Generic Marking.

NOTES:

1. DIMENSIONING AND TOLERANCING PER ASME Y14.5M, 1994
2. CONTROLLING DIMENSION: INCHES
3. MAXIMUM LEAD THICKNESS INCLUDES LEAD FINISH THICKNESS. MINIMUM LEAD THICKNESS IS THE MINIMUM THICKNESS OF THE BASE MATERIAL.

DIM	MILLIMETERS			INCHES		
	MIN.	NOM.	MAX.	MIN.	NOM.	MAX.
A	0.90	1.00	1.10	0.035	0.039	0.043
A1	0.01	0.06	0.10	0.001	0.002	0.004
b	0.25	0.37	0.50	0.010	0.015	0.020
c	0.10	0.18	0.26	0.004	0.007	0.010
D	2.90	3.00	3.10	0.114	0.118	0.122
E	1.30	1.50	1.70	0.051	0.059	0.067
e	0.85	0.95	1.05	0.034	0.037	0.041
H <sub>E</sub>	2.50	2.75	3.00	0.099	0.108	0.118
L	0.20	0.40	0.60	0.008	0.016	0.024
M	0*	---	10*	0*	---	10*



\* For additional information on our Pb-Free strategy and soldering details, please download the DN Semiconductor Soldering and Mounting Techniques Reference Manual, SOLDERM/D.

SOLDERING FOOTPRINT

<p>STYLE 1: PIN 1. CATHODE 2. ANODE 3. CATHODE 4. CATHODE 5. ANODE 6. CATHODE</p>	<p>STYLE 2: PIN 1. NO CONNECTION 2. COLLECTOR 3. EMITTER 4. NO CONNECTION 5. COLLECTOR 6. BASE</p>	<p>STYLE 3: PIN 1. EMITTER 1 2. BASE 1 3. COLLECTOR 2 4. EMITTER 2 5. BASE 2 6. COLLECTOR 1</p>	<p>STYLE 4: PIN 1. COLLECTOR 2 2. EMITTER 1/EMITTER 2 3. COLLECTOR 1 4. EMITTER 3 5. BASE 1/BASE 2/COLLECTOR 3 6. BASE 3</p>	<p>STYLE 5: PIN 1. CHANNEL 1 2. ANODE 3. CHANNEL 2 4. CHANNEL 3 5. CATHODE 6. CHANNEL 4</p>	<p>STYLE 6: PIN 1. CATHODE 2. ANODE 3. CATHODE 4. CATHODE 5. CATHODE 6. CATHODE</p>
<p>STYLE 7: PIN 1. SOURCE 1 2. GATE 1 3. DRAIN 2 4. SOURCE 2 5. GATE 2 6. DRAIN 1</p>	<p>STYLE 8: PIN 1. EMITTER 1 2. BASE 2 3. COLLECTOR 2 4. EMITTER 2 5. BASE 1 6. COLLECTOR 1</p>	<p>STYLE 9: PIN 1. EMITTER 2 2. BASE 2 3. COLLECTOR 1 4. EMITTER 1 5. BASE 1 6. COLLECTOR 2</p>	<p>STYLE 10: PIN 1. ANODE/CATHODE 2. BASE 3. EMITTER 4. COLLECTOR 5. ANODE 6. CATHODE</p>	<p>STYLE 11: PIN 1. EMITTER 2. BASE 3. ANODE/CATHODE 4. ANODE 5. CATHODE 6. COLLECTOR</p>	

DOCUMENT NUMBER:	98ASB42973B	Electronic versions are uncontrolled except when accessed directly from the Document Repository. Printed versions are uncontrolled except when stamped "CONTROLLED COPY" in red.
DESCRIPTION:	SC-74	PAGE 1 OF 1

onsemi and ONSEMI are trademarks of Semiconductor Components Industries, LLC dba onsemi or its subsidiaries in the United States and/or other countries. onsemi reserves the right to make changes without further notice to any products herein. onsemi makes no warranty, representation or guarantee regarding the suitability of its products for any particular purpose, nor does onsemi assume any liability arising out of the application or use of any product or circuit, and specifically disclaims any and all liability, including without limitation special, consequential or incidental damages. onsemi does not convey any license under its patent rights nor the rights of others.

**onsemi**, **Onsemi**, and other names, marks, and brands are registered and/or common law trademarks of Semiconductor Components Industries, LLC dba "**onsemi**" or its affiliates and/or subsidiaries in the United States and/or other countries. **onsemi** owns the rights to a number of patents, trademarks, copyrights, trade secrets, and other intellectual property. A listing of **onsemi**'s product/patent coverage may be accessed at [www.onsemi.com/site/pdf/Patent-Marking.pdf](http://www.onsemi.com/site/pdf/Patent-Marking.pdf). **onsemi** reserves the right to make changes at any time to any products or information herein, without notice. The information herein is provided "as-is" and **onsemi** makes no warranty, representation or guarantee regarding the accuracy of the information, product features, availability, functionality, or suitability of its products for any particular purpose, nor does **onsemi** assume any liability arising out of the application or use of any product or circuit, and specifically disclaims any and all liability, including without limitation special, consequential or incidental damages. Buyer is responsible for its products and applications using **onsemi** products, including compliance with all laws, regulations and safety requirements or standards, regardless of any support or applications information provided by **onsemi**. "Typical" parameters which may be provided in **onsemi** data sheets and/or specifications can and do vary in different applications and actual performance may vary over time. All operating parameters, including "Typicals" must be validated for each customer application by customer's technical experts. **onsemi** does not convey any license under any of its intellectual property rights nor the rights of others. **onsemi** products are not designed, intended, or authorized for use as a critical component in life support systems or any FDA Class 3 medical devices or medical devices with a same or similar classification in a foreign jurisdiction or any devices intended for implantation in the human body. Should Buyer purchase or use **onsemi** products for any such unintended or unauthorized application, Buyer shall indemnify and hold **onsemi** and its officers, employees, subsidiaries, affiliates, and distributors harmless against all claims, costs, damages, and expenses, and reasonable attorney fees arising out of, directly or indirectly, any claim of personal injury or death associated with such unintended or unauthorized use, even if such claim alleges that **onsemi** was negligent regarding the design or manufacture of the part. **onsemi** is an Equal Opportunity/Affirmative Action Employer. This literature is subject to all applicable copyright laws and is not for resale in any manner.

---

## ADDITIONAL INFORMATION

### TECHNICAL PUBLICATIONS:

Technical Library: [www.onsemi.com/design/resources/technical-documentation](http://www.onsemi.com/design/resources/technical-documentation)  
onsemi Website: [www.onsemi.com](http://www.onsemi.com)

### ONLINE SUPPORT: [www.onsemi.com/support](http://www.onsemi.com/support)

For additional information, please contact your local Sales Representative at [www.onsemi.com/support/sales](http://www.onsemi.com/support/sales)