

Edgeboard Connectors, Dual Readout, 0.100" (2.54 mm) C-C, Standard and Right Angle Terminals

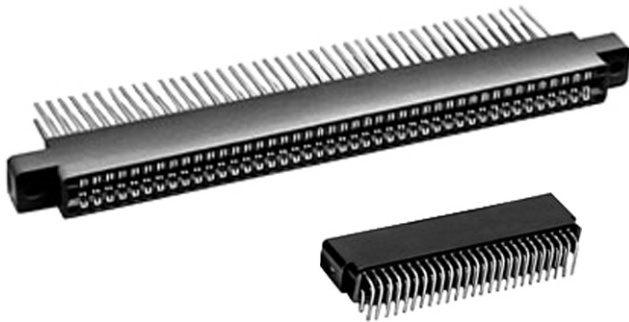

ELECTRICAL SPECIFICATIONS

Current Rating: 3 A

Test Voltage Between Contacts:

at sea level: 650 V_{RMS}

At 70 000 feet (21 336 meters): 275 V_{RMS}

Insulation Resistance: 5000 MΩ minimum at 500 V_{DC} potential

Contact Resistance: 30 mV maximum at rated current (with gold plating)

Operating Temperature: -65 °C to +125 °C

Humidity: 96 h at 90 % relative humidity at +40 °C, dried at room temperature for 3 h minimum, insulation resistance was greater than 5000 MΩ

Durability: after 500 cycles of insertion and withdrawal of a 0.070" (1.78 mm) thick steel test board, contact resistance less than 0.030 V at 3 A on gold plated contacts and individual contact pair separation force when measured with a 0.054" (1.37 mm) thick steel test blade was greater than 1/2 oz.

Shock: three 50G shocks in each of 3 mutually perpendicular planes with no loss of continuity

Vibration: 2 h in each of 3 mutually perpendicular planes, frequency sweep 10 cps to 55 cps at 0.06 double amplitude with no loss of continuity

FEATURES

- Grid patterns: 0.100" C-C x 0.150" (2.54 mm x 3.81 mm) and 0.100" C-C x 0.200" (2.54 mm x 5.08 mm)
- Standard and right angle terminals
- Greater design latitude:
body materials: glass-filled polyester and glass-filled polyphenylene sulfide
7 contact termination styles - 3 standard, 4 right angle
20 body sizes and 6 mounting styles
- Selective gold plating
- Accepts PC board thickness of 0.054" to 0.071" (1.37 mm to 1.80 mm)
- Between contact polarization available (to be installed by customer); between contact polarization permits polarizing without loss of contact position

APPLICATIONS

For use with 0.0625" (1.59 mm) printed circuit boards requiring an edgeboard type connector on 0.100" (2.54 mm) centers

MATERIAL SPECIFICATIONS

Body Material:

"3" thermoplastic polyester, glass-filled, black, flame retardant

"5" thermoplastic polyphenylene sulfid, glass filled, brown, flame retardant

Contacts: phosphor bronze (see Ordering Information)

Polarizing Key: glass reinforced nylon, flame retardant

Plating: gold (see Ordering Information)

ORDERING INFORMATION

EB4	3	-	K	10	SG	XF
MODEL	BODY MATERIAL		TERMINAL VARIATIONS	CONTACTS PER SIDE	CONTACT PLATING	MOUNTING VARIATIONS
	3 = glass-filled polyester 5 = glass-filled polyphenylene sulfide		C, D, K, 1R, 2R, 3R, or 4R	6, 10, 12, 15, 18, 20, 22, 25, 28, 30, 31, 35, 36, 40, 43, 44, 48, 49, 50, 60, or 65	SG = selective gold plating (0.00003" = 0.000762 mm min. thick) on contact area with gold flash on terminal SGF = selective gold plating (0.000010" = 0.000254 mm min. thick) on contact area with gold flash on terminal All gold plating uses 0.00005" = 0.00127 mm min. nickel underplate Contact factory for additional plating options	X, XF, XS, XFS, Y, YF, or W

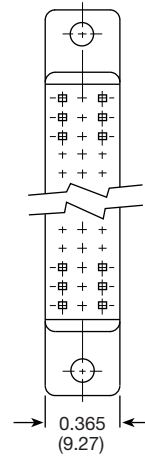
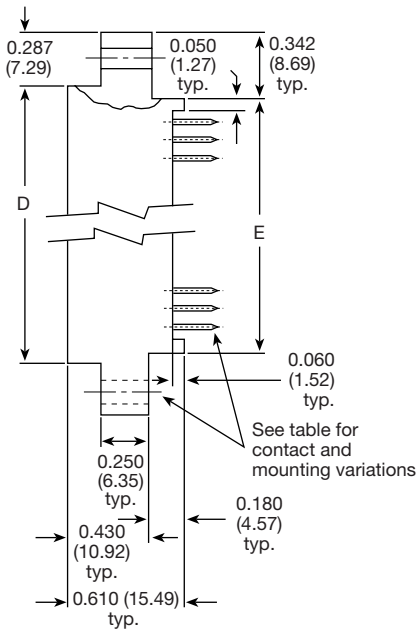
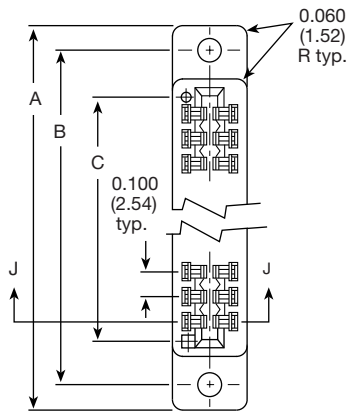
DIMENSIONS in inches (millimeters)

Section J - J

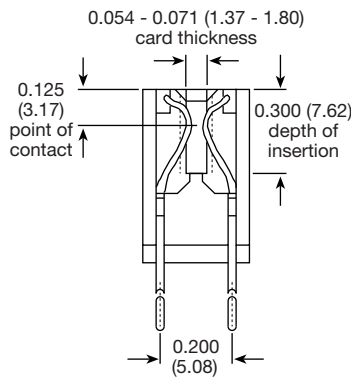

"Between Contacts" Polarizing Key:
 polarizing keys can be ordered separately
 using order code PK-4

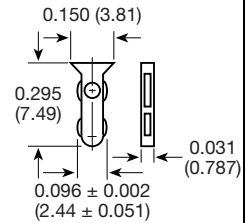

# OF CONTACT POSITIONS PER SIDE	A	B	C	D	E
6	1.435 (36.45)	1.175 (29.85)	0.700 (17.78)	0.860 (21.84)	0.750 (19.05)
10	1.835 (46.61)	1.575 (40.00)	1.100 (27.94)	1.260 (32.00)	1.150 (29.21)
12	2.035 (51.69)	1.775 (45.08)	1.300 (33.02)	1.460 (37.08)	1.350 (34.29)
15	2.335 (59.31)	2.075 (52.70)	1.600 (40.64)	1.760 (44.70)	1.650 (41.91)
18	2.635 (66.93)	2.375 (60.32)	1.900 (48.26)	2.060 (52.32)	1.950 (49.53)
20	2.835 (72.01)	2.575 (65.40)	2.100 (53.34)	2.260 (57.40)	2.150 (54.61)
22	3.035 (77.09)	2.775 (70.48)	2.300 (58.42)	2.460 (62.48)	2.350 (59.69)
25	3.335 (84.71)	3.075 (78.10)	2.600 (66.04)	2.760 (70.10)	2.650 (67.31)
28	3.635 (92.33)	3.375 (85.72)	2.900 (73.66)	3.060 (77.72)	2.950 (74.93)
30	3.835 (97.41)	3.575 (90.80)	3.100 (78.74)	3.260 (82.80)	3.150 (80.01)
31	3.935 (99.95)	3.675 (93.34)	3.200 (81.28)	3.360 (85.34)	3.250 (82.55)
35	4.335 (110.11)	4.075 (103.50)	3.600 (91.44)	3.760 (95.50)	3.650 (92.71)
36	4.435 (112.65)	4.175 (106.04)	3.700 (93.98)	3.860 (98.04)	3.750 (95.25)
40	4.835 (122.81)	4.575 (116.20)	4.100 (104.14)	4.260 (108.20)	4.150 (105.41)
43	5.135 (130.43)	4.875 (123.82)	4.400 (111.76)	4.560 (115.82)	4.450 (113.03)
44	5.235 (132.97)	4.975 (126.36)	4.500 (114.30)	4.660 (118.36)	4.550 (115.57)
48	5.635 (143.13)	5.375 (136.52)	4.900 (124.46)	5.060 (128.52)	4.950 (125.73)
49	5.735 (145.67)	5.475 (139.06)	5.000 (127.00)	5.160 (131.06)	5.050 (128.27)
50	5.835 (148.21)	5.575 (141.60)	5.100 (129.54)	5.260 (133.60)	5.150 (130.81)
60	6.835 (173.61)	6.575 (167.00)	6.100 (154.94)	6.260 (159.00)	6.150 (156.21)
65	7.335 (186.31)	7.075 (179.70)	6.600 (167.64)	6.760 (171.70)	6.650 (168.91)

PHYSICAL SPECIFICATIONS

Contact Type: bifurcated cantilever beam
Number of Contacts: 10, 12, 15, 18, 20, 22, 25, 28, 30, 31, 35, 36, 40, 43, 44, 48, 49, 50, 60 and 65 per side
Contact Terminal Variation: Standard terminals
Type "C" - dip solder, 0.025" (0.635 mm) square terminals, 0.175" (4.44 mm) nominal terminal length below standoffs
Type "D" - dip solder, 0.025" (0.635 mm) square terminals, 0.115" (2.92 mm) nominal terminal length below standoffs
Type "K" - Wire Wrap™, 0.025" (0.635 mm) square terminals, 0.570" (14.48 mm) nominal terminal length below standoffs
Contact Terminal Variation: Right angle terminals
Type "1R" - dip solder, 0.025" (0.635 mm) square terminals, 0.120" (3.05 mm) nominal terminal length x 0.150" (3.81 mm) nominal terminal row spacing
Type "2R" - dip solder, 0.025" (0.635 mm) square terminals, 0.120" (3.05 mm) nominal terminal length x 0.200" (5.08 mm) nominal terminal row spacing

Type "3R" - dip solder, 0.025" (0.635 mm) square terminals, 0.180" (4.57 mm) nominal terminal length x 0.150" (3.81 mm) nominal terminal row spacing
Type "4R" - dip solder, 0.025" (0.635 mm) square terminals, 0.180" (4.57 mm) nominal terminal length x 0.200" (5.08 mm) nominal terminal row spacing
Contact Spacing: 0.100" (2.54 mm) center to center
Contact Terminal Row Spacing: Standard - 0.200" (5.08 mm) nominal. Right angle - 0.200" (5.08 mm) nominal and 0.150" (3.81 mm) nominal
Card Thickness: 0.054" to 0.071" (1.37 mm to 1.80 mm)
Card Slot Depth: 0.300" (7.62 mm)
Connector Polarization: between contact polarization key(s) are located to the right of the contact position(s) designated

Note
 • High temperature burn-in, edgeboard connectors, with 0.100" (2.54 mm) center to center are on www.vishay.com/doc?36006

MOUNTING VARIATIONS in inches (millimeters)

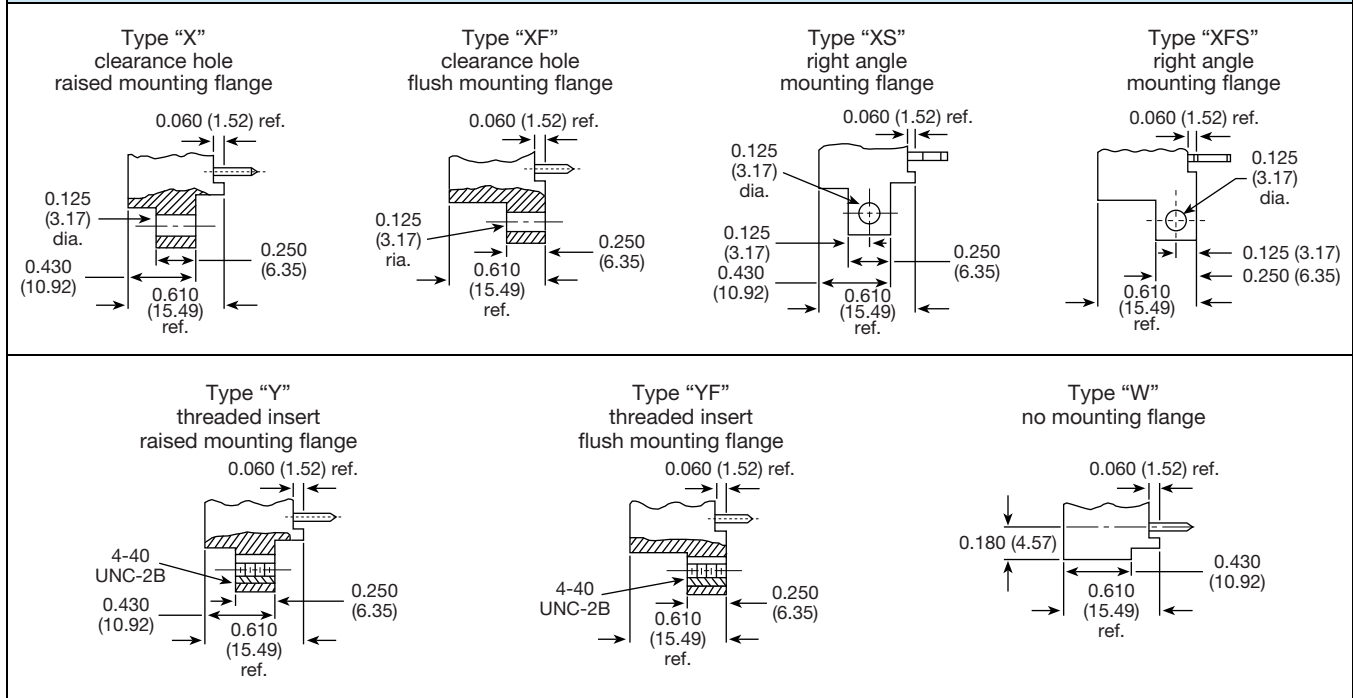

TERMINAL VARIATIONS in inches (millimeters)

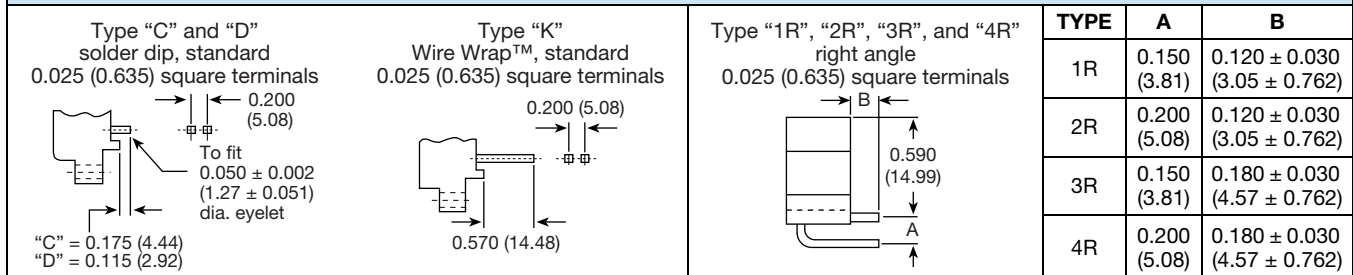



Disclaimer

ALL PRODUCT, PRODUCT SPECIFICATIONS AND DATA ARE SUBJECT TO CHANGE WITHOUT NOTICE TO IMPROVE RELIABILITY, FUNCTION OR DESIGN OR OTHERWISE.

Vishay Intertechnology, Inc., its affiliates, agents, and employees, and all persons acting on its or their behalf (collectively, "Vishay"), disclaim any and all liability for any errors, inaccuracies or incompleteness contained in any datasheet or in any other disclosure relating to any product.

Vishay makes no warranty, representation or guarantee regarding the suitability of the products for any particular purpose or the continuing production of any product. To the maximum extent permitted by applicable law, Vishay disclaims (i) any and all liability arising out of the application or use of any product, (ii) any and all liability, including without limitation special, consequential or incidental damages, and (iii) any and all implied warranties, including warranties of fitness for particular purpose, non-infringement and merchantability.

Statements regarding the suitability of products for certain types of applications are based on Vishay's knowledge of typical requirements that are often placed on Vishay products in generic applications. Such statements are not binding statements about the suitability of products for a particular application. It is the customer's responsibility to validate that a particular product with the properties described in the product specification is suitable for use in a particular application. Parameters provided in datasheets and / or specifications may vary in different applications and performance may vary over time. All operating parameters, including typical parameters, must be validated for each customer application by the customer's technical experts. Product specifications do not expand or otherwise modify Vishay's terms and conditions of purchase, including but not limited to the warranty expressed therein.

Hyperlinks included in this datasheet may direct users to third-party websites. These links are provided as a convenience and for informational purposes only. Inclusion of these hyperlinks does not constitute an endorsement or an approval by Vishay of any of the products, services or opinions of the corporation, organization or individual associated with the third-party website. Vishay disclaims any and all liability and bears no responsibility for the accuracy, legality or content of the third-party website or for that of subsequent links.

Vishay products are not designed for use in life-saving or life-sustaining applications or any application in which the failure of the Vishay product could result in personal injury or death unless specifically qualified in writing by Vishay. Customers using or selling Vishay products not expressly indicated for use in such applications do so at their own risk. Please contact authorized Vishay personnel to obtain written terms and conditions regarding products designed for such applications.

No license, express or implied, by estoppel or otherwise, to any intellectual property rights is granted by this document or by any conduct of Vishay. Product names and markings noted herein may be trademarks of their respective owners.