

ITEM NO.	PART NUMBER	DESCRIPTION	QTY.	COMPONENT NOTES
1	50-00057	Connector, dc jack, 3.5x1.35xL16.5 mm, molding style	3	
2	30-00003	Wire, 2C BC, 24 AWG, UL2468, 300V, 80C, 3.6 mm, VW-1, PVC, 76A	3	
3	24-00005	Overmold, PVC	3	black
4	24-00195	Overmold, splitter, Ø 8.0 mm by 10.0x13.0 mm	1	black

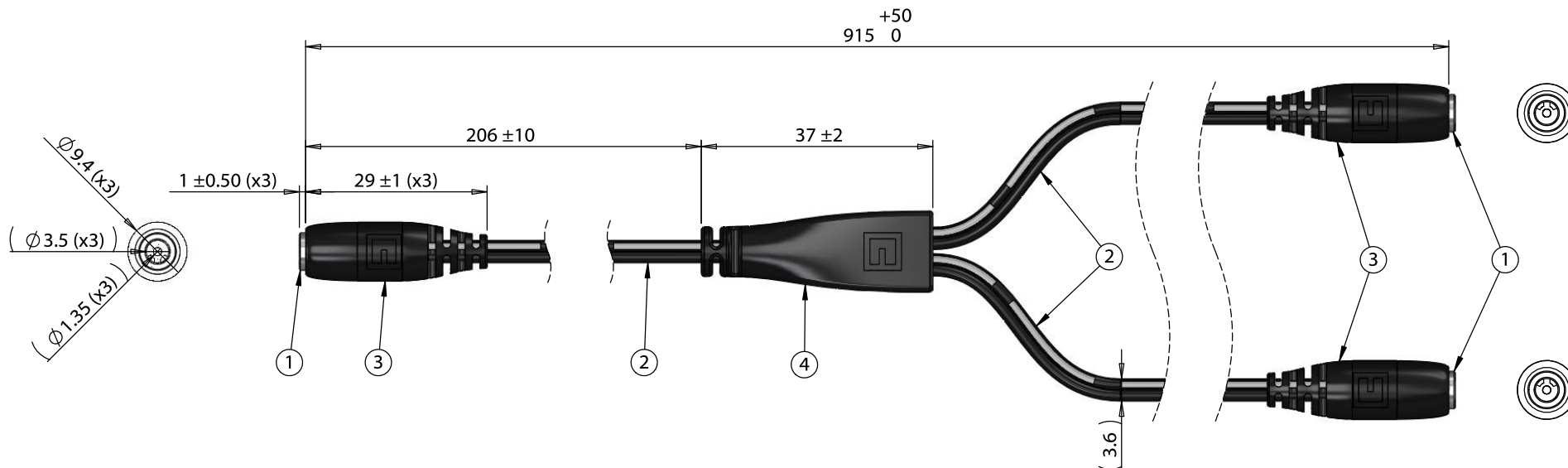

Notes:
Functionally equivalent components may be substituted

Wiring Diagram		
50-00057	wire color	50-00057
center	black with stripe	center
sleeve	black	sleeve

Revision: A	Date: 4/13/2018	Description: Initial release	Prepared: JP <small>Digitally signed by JP Date: 2018.04.13 16:36:46 -07'00'</small>	Notes: RoHS compliant Function test: no open, no short circuit, no intermittent	<h1>TENSILITY</h1> <p>tel 1.541.323.3228 800 877.670.7118 fax 1.541.323.4202 web tensility.com</p>
			Verified: AW <small>Digitally signed by AW Date: 2018.04.16 16:08:12 -07'00'</small>		
			Dimensions are in millimeters. Tolerances: X: ± 0.5 mm X.X: ± 0.3 mm X.XX: ± 0.05 mm	Description: Cable, 915 mm, 3.5x1.35 mm 50-00057 dc jack to y-split to 2x 3.5x1.35 mm dc jack, 24 AWG	Size: A Part number: 10-02794
					Scale: 1:1 Sheet 1 of 1

5

4

3

2

1