

# PANDUCT® Wiring Duct and Accessories

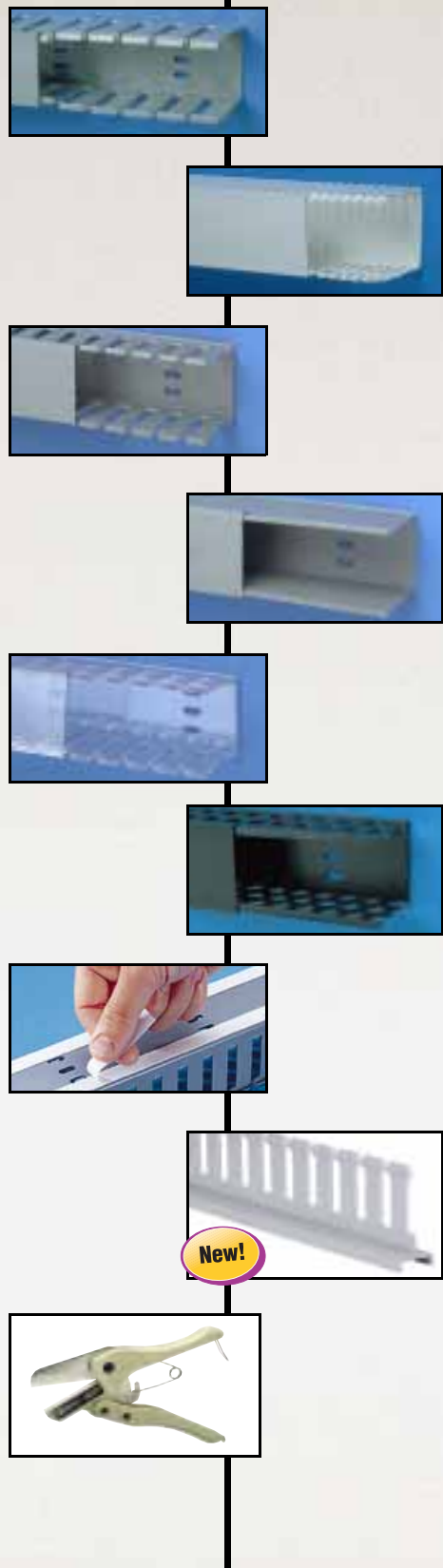

## Table of Contents

### Wiring Duct Applications

Wiring Duct Applications..... 2-3

### Slotted Wall Wiring Duct

Type G Part Numbers & **New** Sizes..... 4

Type F Part Numbers & **New** Sizes..... 6

Type E Part Numbers & Sizes..... 20

### Solid Wall Raceway

Type FS Part Numbers & **New** Sizes..... 8

Type S Part Numbers & Sizes..... 21

### Halogen Free Slotted Wall Wiring Duct

Type NE Part Numbers & Sizes..... 10

### Halogen Free Solid Wall Raceway

Type NS Part Numbers & Sizes..... 12

### Polycarbonate Slotted Wall Wiring Duct

Type PE Part Numbers & Sizes..... 14

### Polycarbonate Solid Wall Raceway

Type PS Part Numbers & Sizes..... 16

### Round Hole Wiring Duct

Type D Part Numbers & Sizes..... 18

### Adhesive Backed Wiring Duct

Factory Applied Adhesive Backed Duct..... 22

Adhesive Tape (in rolls)..... 22

### PANDUCT® Accessories

Solid and **New** Slotted Divider Wall..... 24

**New** Wire Retainers..... 25

Duct and Corner Joining Strips..... 26

Mounting Brackets..... 27

Labeling..... 28

### PANDUCT® Installation Tools

Duct Cutting Tool..... 23

Duct Finger Notching Tool..... 23

Nylon Rivet Installation Tool..... 23

### Technical Data

Dimensional & Wirefill Information..... 29-33

Material Physical Properties..... 34-35

Color Selection Chart..... 36

Alphabetical Part Number Index..... 37-38



# PANDUCT

WIRING DUCT AND ACCESSORIES

## Puts Remote Cabling Possibilities Within Reach

- More colors, styles, sizes, and materials to choose from.
- Time saving features lower your installed cost.
- Comprehensive line of accessories for custom cabling applications.

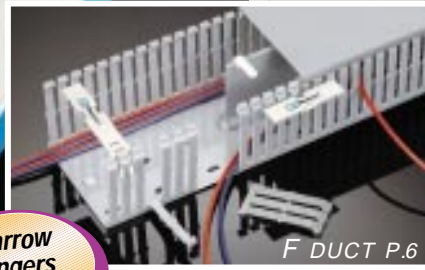

Narrow Fingers  
IN 29 SIZES

F DUCT P.6



Slotted or Solid Wall  
IN 30 SIZES

NS RACEWAY P.12

### HALOGEN FREE APPLICATIONS

Made of chlorine-free material for low halogen, low smoke requirements.

Slotted or Solid Wall  
IN 30 SIZES

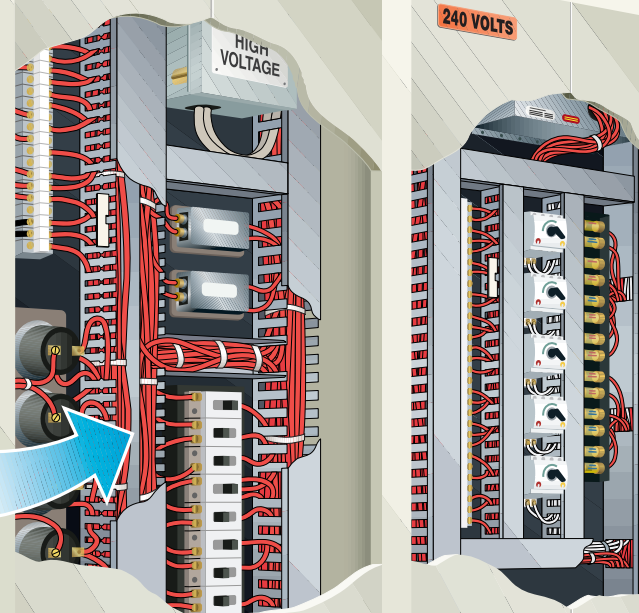

HIGH VOLTAGE

240 VOLTS

### REGULAR PANEL APPLICATIONS

For the control panel, communication closet, and other controlled environments.

Extra Wide Fingers  
IN 34 SIZES

Solid Wall  
IN 34 SIZES

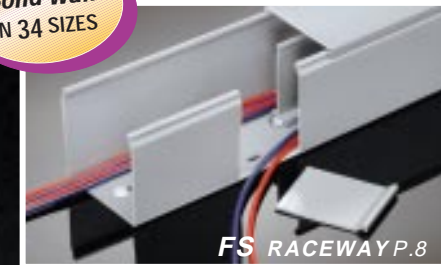

FS RACEWAY P.8

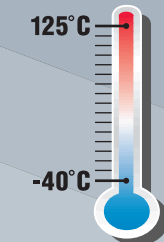

### EXTREME TEMPERATURE APPLICATIONS

Rated for continuous use in temperatures from 0 40°C (0 40°F) to 125°C (257°F).



Slotted or Solid Wall  
IN 7 SIZES

PS RACEWAY P.16



# PANDUCT

WIRING DUCT AND ACCESSORIES

## Puts Remote Cabling Possibilities Within Reach

- More colors, styles, sizes, and materials to choose from.
- Time saving features lower your installed cost.
- Comprehensive line of accessories for custom cabling applications.



### HALOGEN FREE APPLICATIONS

Made of chlorine-free material for low halogen, low smoke requirements.

Slotted or Solid Wall  
IN 30 SIZES

NS RACEWAY P.12

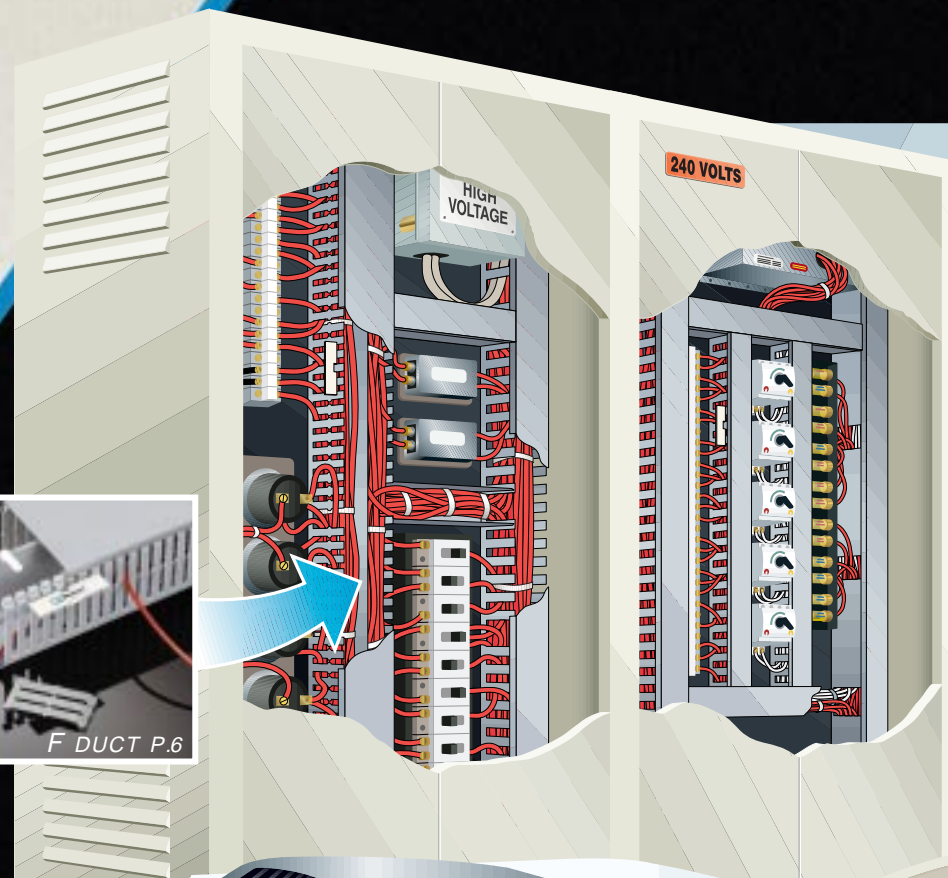

Narrow Fingers  
IN 29 SIZES

### REGULAR PANEL APPLICATIONS

For the control panel, communication closet, and other controlled environments.

Extra Wide Fingers  
IN 34 SIZES

Solid Wall  
IN 34 SIZES

FS RACEWAY P.8



125°C

-40°C

### EXTREME TEMPERATURE APPLICATIONS

Rated for continuous use in temperatures from 0 40°C (0 40°F) to 125°C (257°F).

PE DUCT P.14

Slotted or Solid Wall  
IN 7 SIZES

PS RACEWAY P.16



# PANDUCT® Type G — Slotted Wall Wiring Duct

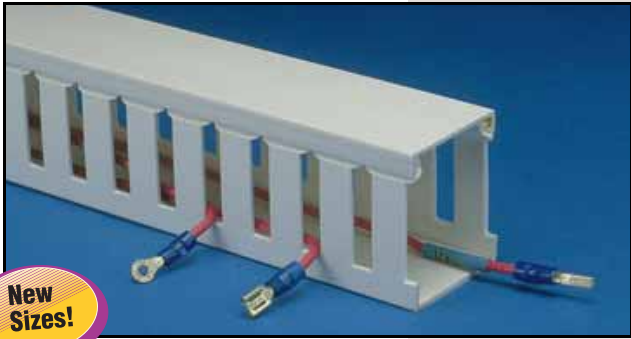

## Type G Slotted Wall Wiring Duct

- Made of rigid PVC (See [pg. 34](#) for material specifications)
- Rated for continuous use temperatures up to 50°C (122°F)
- U.L. Flammability Rating: V-0
- Available in a variety of colors as a standard part†
- Provided with standard mounting holes (dimensions see [pg. 29](#))
- Available without mounting holes (See ordering information below)
- Available with adhesive backing\* (See [page 22](#) for details)



### Type G— Wiring Duct Standard Colors†:

LG	DG	WH
Light Gray	Dark Gray	White
BL	IB	
Black	Intrinsic Blue	

Colors shown are approximate.

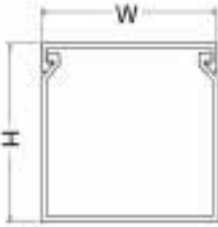

### Ordering Information:

- Order number of feet required in multiples of 6 ft or Std. Carton quantities.
- To order duct without mounting holes, add NM to Part Number.
- To order with pressure-sensitive adhesive mounting tape applied, add -A to Part Number.
- Part Number shown for Light Gray LG. To order other colors, substitute WH for White, DG for Dark Gray, BL for Black, and IB for Intrinsic Blue

†See [page 36](#) to determine which sizes are available in each color

Duct Part Number	Duct External Dimensions		Cover Part Number	Duct Std. Ctn. Qty.	Cover Std. Ctn. Qty.	Std. Lgth
	WxH IN.	WxH (mm)				
✓ G.5X.5LG6 ✓ G.5X1LG6	0.69 x .56 0.69 x 1.09	(17.5) x (14.2) (17.5) x (27.1)	C.5LG6	120 ft. 120 ft.	120 ft. 120 ft.	6 ft.
✓ G.75X.75LG6 ✓ G.75X1LG6 ✓ G.75X1.5LG6 ✓ G.75X2LG6	0.94 x 0.83 0.94 x 1.09 0.94 x 1.58 0.94 x 2.09	(23.9) x (21.0) (23.9) x (27.1) (23.9) x (40.0) (23.9) x (53.0)	C.75LG6	120 ft. 120 ft. 120 ft. 120 ft.	120 ft. 120 ft. 120 ft. 120 ft.	6 ft.
G1X1LG6 G1X1.5LG6 G1X2LG6 G1X3LG6 G1X4LG6	1.25 x 1.09 1.25 x 1.59 1.25 x 2.09 1.25 x 3.10 1.25 x 4.10	(31.8) x (27.1) (31.8) x (40.3) (31.8) x (53.0) (31.8) x (78.6) (31.8) x (104.0)	C1LG6	120 ft. 120 ft. 120 ft. 120 ft. 60 ft.	120 ft. 120 ft. 120 ft. 120 ft. 120 ft.	6 ft.
G1.5X1 LG6 G1.5X1.5LG6 G1.5X2LG6 G1.5X3LG6 G1.5X4LG6	1.75 x 1.09 1.75 x 1.59 1.75 x 2.09 1.75 x 3.10 1.75 x 4.10	(44.5) x (27.1) (44.5) x (40.3) (44.5) x (53.0) (44.5) x (78.6) (44.5) x (104.0)	C1.5LG6	120 ft. 120 ft. 120 ft. 120 ft. 60 ft.	120 ft. 120 ft. 120 ft. 120 ft. 120 ft.	6 ft.
G2X1 LG6 G2X1.5LG6 G2X2LG6 G2X3LG6 G2X4LG6 G2X5LG6	2.25 x 1.09 2.25 x 1.59 2.25 x 2.09 2.25 x 3.10 2.25 x 4.10 2.25 x 5.11	(57.2) x (27.1) (57.2) x (40.3) (57.2) x (53.0) (57.2) x (78.6) (57.2) x (104.0) (57.2) x (129.7)	C2LG6	120 ft. 120 ft. 120 ft. 60 ft. 60 ft. 60 ft.	120 ft. 120 ft. 120 ft. 120 ft. 120 ft. 120 ft.	6 ft.
✓ G2.5X3LG6	2.75 x 3.12	(69.9) x (79.2)	C2.5LG6	60 ft.	120 ft.	6 ft.
G3X1LG6 G3X2LG6 G3X3LG6 G3X4LG6 G3X5LG6	3.25 x 1.09 3.25 x 2.09 3.25 x 3.10 3.25 x 4.10 3.25 x 5.11	(82.6) x (27.6) (82.6) x (53.0) (82.6) x (78.6) (82.6) x (104.0) (82.6) x (129.7)	C3LG6	120 ft. 120 ft. 60 ft. 60 ft. 60 ft.	120 ft. 120 ft. 120 ft. 120 ft. 120 ft.	6 ft.
✓ G4X1.5LG6 ✓ G4X2LG6 ✓ G4X3LG6 ✓ G4X4LG6 ✓ G4X5LG6	4.25 x 1.58 4.25 x 2.09 4.25 x 3.10 4.25 x 4.10 4.25 x 5.11	(108.0) x (40.0) (108.0) x (53.0) (108.0) x (78.6) (108.0) x (104.0) (108.0) x (129.7)	C4LG6	60 ft. 60 ft. 60 ft. 60 ft. 60 ft.	120 ft. 120 ft. 120 ft. 120 ft. 120 ft.	6 ft.
✓ G6X4LG6	6.25 x 4.11	(158.8) x (104.4)	C6LG6	60 ft.	120 ft.	6 ft.

\*Adhesive tape is not CSA Certified. See [page 29](#) for complete listing of dimensions. ✓=New Sizes

### Part Number Nomenclature —

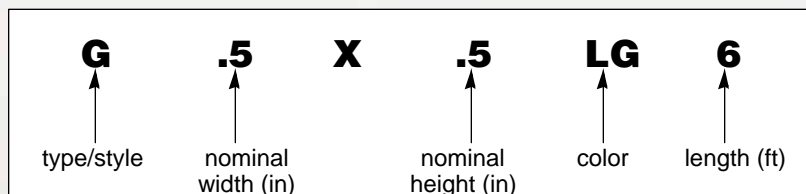

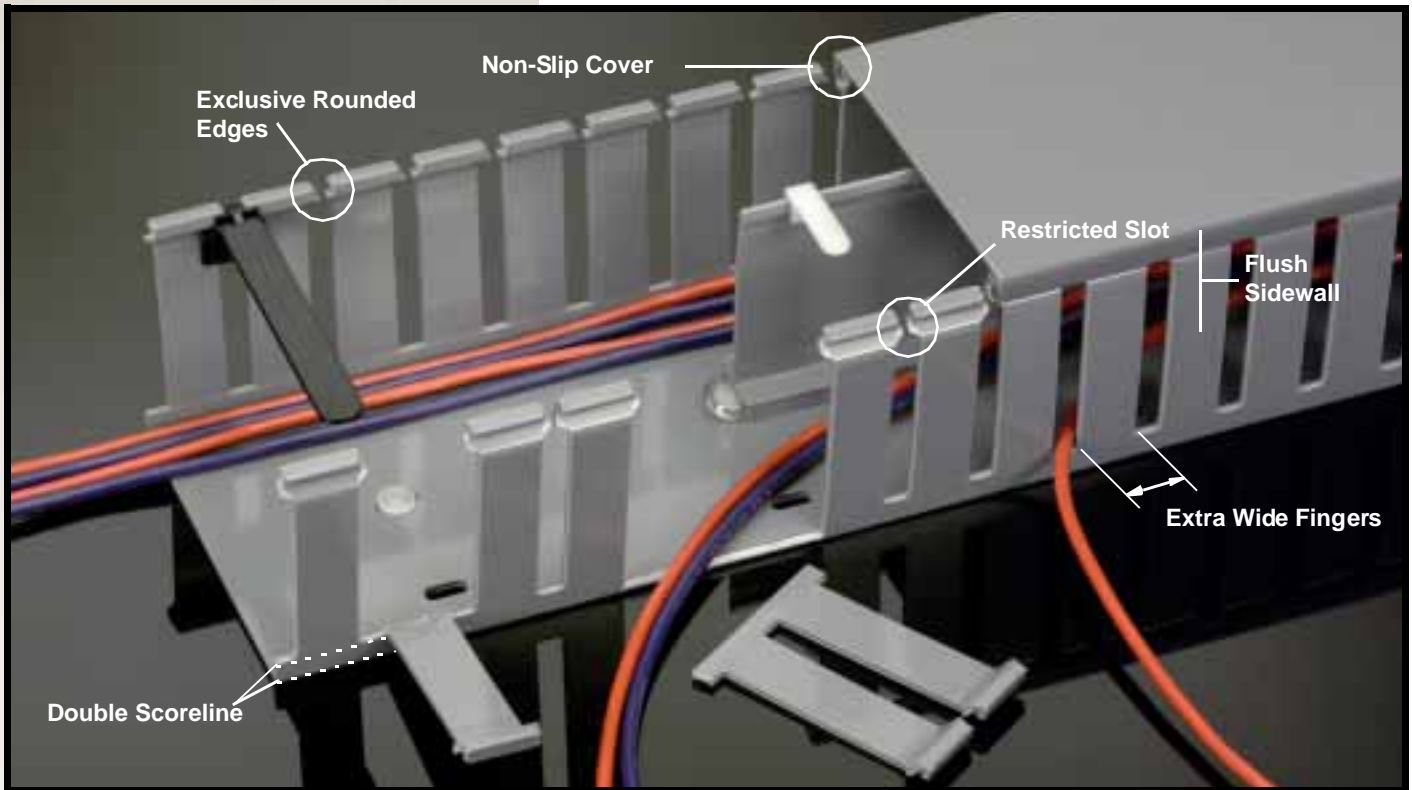

## Type G Slotted Wall Wiring Duct

Choose from **34** sizes of Panduit Type G Wiring Duct; from **0.5" x 0.5" up to 6" x 4"**. Used for general purpose control panel wiring and to route and protect wiring in communication closets. The non-slip cover conceals all wiring and is easy to install. The duct and cover form a flush sidewall providing increased capacity and improved aesthetics.

### Accessories

Duct Cutting Tool .....	23
Duct Finger Notching Tool .....	23
Nylon Rivet Installation Tool .....	23
Divider Walls.....	24
Wire Retainers.....	25
Optional Mounting Clip.....	27
Labeling .....	28

### Features & Benefits

- Wide Fingers**
  - Provide added support
  - Same slot and finger width as Type E duct
- Flush Cover with Base**
  - Improves aesthetics
  - Provides greater wire capacity
- Restricted Slot Design**
  - Retains wire in slot
  - Speeds installation
    - Simply deflect finger for fast, easy wire installation or removal
- Optional Divider Walls**
  - Can create multiple channels within one duct to separate wiring
- Exclusive Rounded Edges Along Entire Slot**
  - Protect wires and hands from abrasion
- Non-Slip Cover Design**
  - Incorporates integral high friction lining to inhibit cover movement
- Easy Cover Removal**
  - Changes to wiring can be made quickly & easily
- Double Scorelines**
  - Upper Scoreline:
    - Fingers break off leaving a smooth edge, without the use of a tool
  - Lower Scoreline:
    - Fingers and sidewall break off flush with base for junctions. (Use DNT-100 Tool to cut side wall)
- Bar Coded Part Number Label with QC Number**
  - Allows for automated inventory control systems
  - Quick identification of loose piece wiring duct
  - Complete Quality Traceability
- Optional Pressure-Sensitive Adhesive Mounting Tape**

# PANDUCT® Type F — Slotted Wall Wiring Duct



**New Sizes!**

## Type F Slotted Wall Wiring Duct

- Made of rigid PVC (See [pg. 34](#) for material specifications)
- Rated for continuous use temperatures up to 50°C (122°F)
- U.L. Flammability Rating: V-0
- Available in a Light Gray and White color†
- Provided with standard mounting holes (dimensions see [pg. 30](#))
- Available without mounting holes (See ordering information below)
- Available with adhesive backing\* (See [page 22](#) for details)



### Type F— Wiring Duct Standard Colors†:

LG	WH
Light Gray	White

Colors shown are approximate.

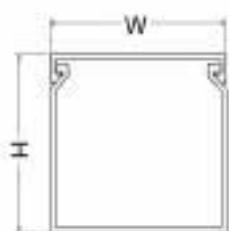

Duct Part Number	Duct External Dimensions		Cover Part Number	Duct Std. Ctn. Qty.	Cover Std. Ctn. Qty.	Std. Lgth
	WxH IN.	WxH (mm)				
F.5X.5LG6 F.5X1LG6	0.69 x 0.56 0.69 x 1.09	(17.5) x (14.2) (17.5) x (27.1)	C.5LG6	120 ft. 120 ft.	120 ft. 120 ft.	6 ft.
F.75X.75LG6 F.75X1.5LG6	0.94 x 0.83 0.94 x 1.58	(23.9) x (21.0) (23.9) x (40.0)	C.75LG6	120 ft. 120 ft.	120 ft. 120 ft.	6 ft.
F1X1LG6 F1X1.5LG6 F1X2LG6 F1X3LG6 F1X4LG6	1.25 x 1.09 1.25 x 1.59 1.25 x 2.09 1.25 x 3.10 1.25 x 4.10	(31.8) x (27.1) (31.8) x (40.3) (31.8) x (53.0) (31.8) x (78.6) (31.8) x (104.0)	C1LG6	120 ft. 120 ft. 120 ft. 120 ft. 60 ft.	120 ft. 120 ft. 120 ft. 120 ft. 120 ft.	6 ft.
F1.5X1 LG6 F1.5X1.5LG6 F1.5X2LG6 F1.5X3LG6 F1.5X4LG6	1.75 x 1.09 1.75 x 1.59 1.75 x 2.09 1.75 x 3.10 1.75 x 4.10	(44.5) x (27.1) (44.5) x (40.3) (44.5) x (53.0) (44.5) x (78.6) (44.5) x (104.0)	C1.5LG6	120 ft. 120 ft. 120 ft. 120 ft. 60 ft.	120 ft. 120 ft. 120 ft. 120 ft. 120 ft.	6 ft.
F2X1 LG6 F2X1.5LG6 F2X2LG6 F2X3LG6 F2X4LG6 F2X5LG6	2.25 x 1.09 2.25 x 1.59 2.25 x 2.09 2.25 x 3.10 2.25 x 4.10 2.25 x 5.11	(57.2) x (27.1) (57.2) x (40.3) (57.2) x (53.0) (57.2) x (78.6) (57.2) x (104.0) (57.2) x (129.7)	C2LG6	120 ft. 120 ft. 120 ft. 60 ft. 60 ft. 60 ft.	120 ft. 120 ft. 120 ft. 120 ft. 120 ft. 120 ft.	6 ft.
F3X1LG6 F3X2LG6 F3X3LG6 F3X4LG6 F3X5LG6	3.25 x 1.09 3.25 x 2.09 3.25 x 3.10 3.25 x 4.10 3.25 x 5.11	(82.6) x (27.6) (82.6) x (53.0) (82.6) x (78.6) (82.6) x (104.1) (82.6) x (129.8)	C3LG6	120 ft. 120 ft. 60 ft. 60 ft. 60 ft.	120 ft. 120 ft. 120 ft. 120 ft. 120 ft.	6 ft.
F4X2LG6 F4X3LG6 F4X4LG6 F4X5LG6	4.25 x 2.09 4.25 x 3.10 4.25 x 4.10 4.25 x 5.11	(108.0) x (53.0) (108.0) x (78.6) (108.0) x (104.1) (108.0) x (129.8)	C4LG6	60 ft. 60 ft. 60 ft. 60 ft.	120 ft. 120 ft. 120 ft. 120 ft.	6 ft.

\*Adhesive tape is not CSA Certified.  
See [page 30](#) for complete listing of dimensions. ✓=New Sizes

### Ordering Information:

- Order number of feet required in multiples of 6 ft or Std. Carton quantities.
- To order duct without mounting holes, add NM to Part Number.
- To order with pressure-sensitive adhesive mounting tape applied, add -A to Part Number.
- Part Number shown for Light Gray LG. To order other colors, substitute WH White, DG Dark Gray, BL Black, and IB Intrinsic Blue

†See [page 36](#) to determine which sizes are available in each color

### Part Number Nomenclature —

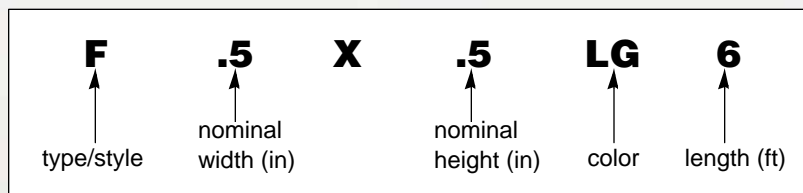

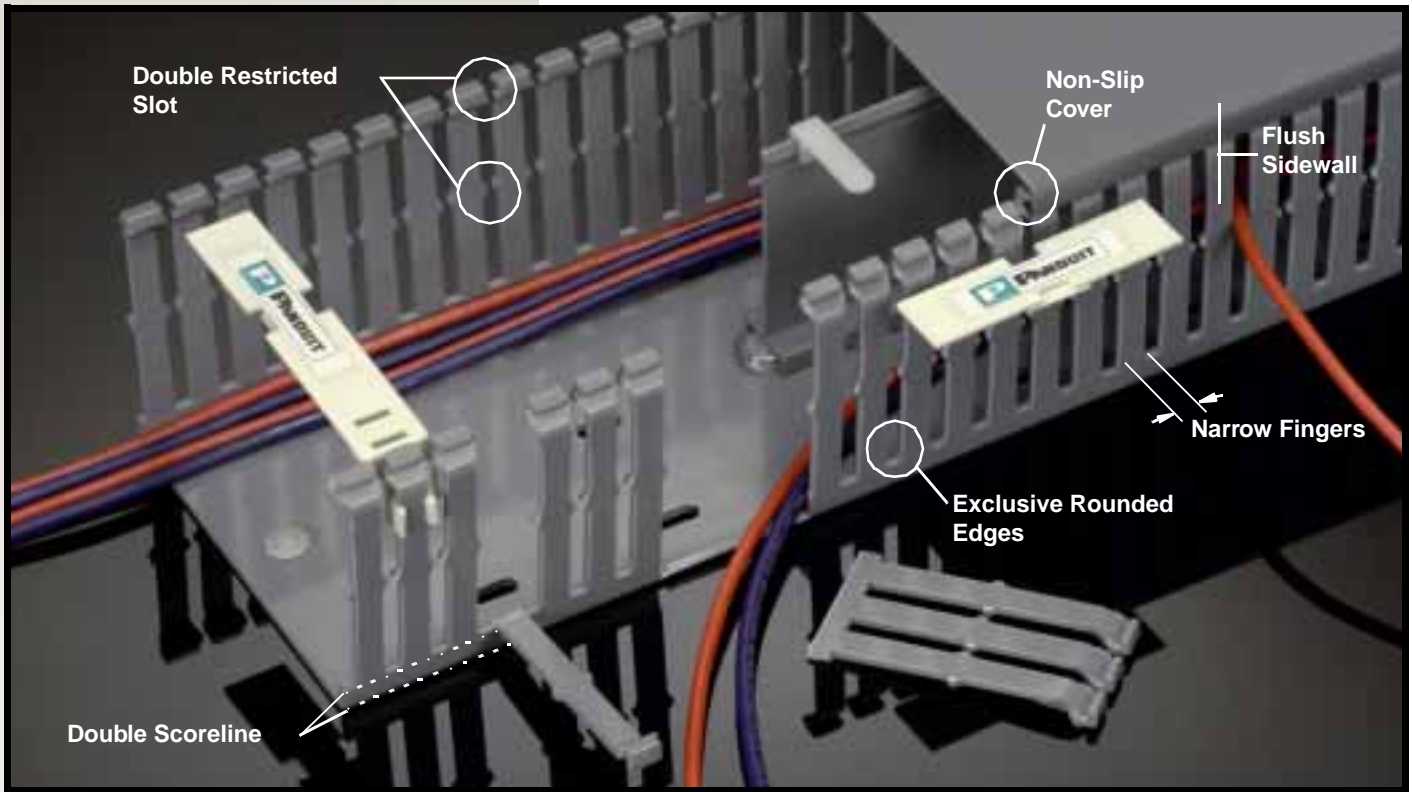

## Type F Slotted Wall Wiring Duct

Choose from **29** sizes of Panduit Type F Wiring Duct; from **.5" x .5" up to 4" x 5"**. Used for general purpose control panel wiring and to route and protect wiring in communication closets. Ideal for use with high density terminal blocks. The non-slip cover conceals all wiring and is easy to install. The duct and cover form a flush sidewall providing increased capacity and improved aesthetics.

### Accessories

Duct Cutting Tool .....	23
Duct Finger Notching Tool .....	23
Nylon Rivet Installation Tool .....	23
Divider Walls.....	24
Wire Retainers.....	25
Optional Mounting Clip.....	27
Labeling .....	28

## Features & Benefits

### Narrow Fingers

- Less “fanning” of wires for a neater appearance
- Provides the proper spacing for use with high density terminal blocks

### Restricted Slot Design

- Retains wire in slot
- Speeds installation
- Simply deflect finger for fast, easy wire installation or removal

### Double Restricted Slot On Larger Sizes

- Retains wires in top or bottom slot
- Speeds installation

### Flush Cover with Base

- Improves aesthetics
- Provides greater wire capacity

### Optional Divider Wall

- Can create multiple channels within one duct to separate wiring

### Exclusive Rounded Edges Along Entire Slot

- Protect wires and hands from abrasion

### Non-Slip Cover Design

- Incorporates integral high friction lining to inhibit cover movement

### Easy Cover Removal

- Changes to wiring can be made quickly & easily

### Double Scorelines

- Upper Scoreline:
  - Fingers break off leaving a smooth edge, without the use of a tool
- Lower Scoreline:
  - Fingers and sidewall break off flush with base for junctions. (Use DNT-100 Tool to cut side wall)

### Bar Coded Part Number Label with QC Number

- Allows for automated inventory control systems
- Quick identification of loose piece duct
- Complete Quality Traceability

### Optional Pressure-Sensitive Adhesive Mounting Tape



# PANDUCT® Type FS — Solid Wall Raceway

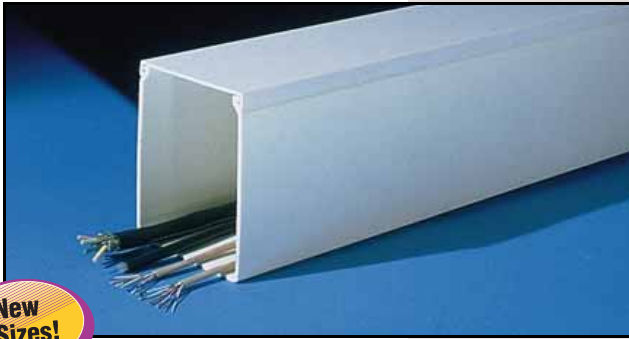

**New Sizes!**

## Type FS Solid Wall Raceway

- Made of rigid PVC (See [pg. 34](#) for material specifications)
- Rated for continuous use temperatures up to 50°C (122°F)
- U.L. Flammability Rating: V-0
- Available in a variety of colors as a standard part†
- Supplied without mounting holes
- Available with mounting holes (See ordering information below)
- Available with adhesive backing\* (See [page 22](#) for details)



### Type FS— Wiring Duct Standard Colors†:

<b>LG</b> Light Gray	<b>DG</b> Dark Gray	<b>WH</b> White
<b>BL</b> Black	<b>IB</b> Intrinsic Blue	

Colors shown are approximate.

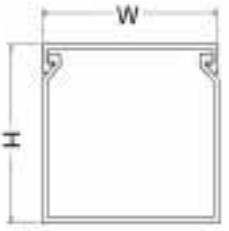

### Ordering Information:

- Order number of feet required in multiples of 6 ft or Std. Carton quantities.
- To order duct with mounting holes, delete NM from Part Number.
- To order with pressure-sensitive adhesive mounting tape applied, add -A to Part Number.
- Part Number shown for Light Gray LG. To order other colors, substitute WH for White, DG for Dark Gray, BL for Black, and IB for Intrinsic Blue

†See [page 36](#) to determine which sizes are available in each color

Raceway Part Number	Raceway External Dimensions		Cover Part Number	Raceway Std. Ctn. Qty.	Cover Std. Ctn. Qty.	Std. Lgth
	WxH IN.	WxH (mm)				
FS.5X.5LG6NM FS.5X1LG6NM	0.69 x 0.56 0.69 x 1.09	(17.5) x (14.2) (17.5) x (27.1)	C.5LG6	120 ft. 120 ft.	120 ft. 120 ft.	6 ft.
✓ FS.75X.75LG6NM ✓ FS.75X1LG6NM ✓ FS.75X1.5LG6NM ✓ FS.75X2LG6NM	0.94 x 0.83 0.94 x 1.09 0.94 x 1.58 0.94 x 2.09	(23.9) x (21.0) (23.9) x (27.1) (23.9) x (40.0) (23.9) x (53.0)	C.75LG6	120 ft. 120 ft. 120 ft. 120 ft.	120 ft. 120 ft. 120 ft. 120 ft.	6 ft.
FS1X1LG6NM FS1X1.5LG6NM FS1X2LG6NM FS1X3LG6NM FS1X4LG6NM	1.25 x 1.09 1.25 x 1.59 1.25 x 2.09 1.25 x 3.10 1.25 x 4.10	(31.8) x (27.1) (31.8) x (40.3) (31.8) x (53.0) (31.8) x (78.6) (31.8) x (104.0)	C1LG6	120 ft. 120 ft. 120 ft. 120 ft. 60 ft.	120 ft. 120 ft. 120 ft. 120 ft. 120 ft.	6 ft.
FS1.5X1 LG6NM FS1.5X1.5LG6NM FS1.5X2LG6NM FS1.5X3LG6NM FS1.5X4LG6NM	1.75 x 1.09 1.75 x 1.59 1.75 x 2.09 1.75 x 3.10 1.75 x 4.10	(44.5) x (27.1) (44.5) x (40.3) (44.5) x (53.0) (44.5) x (78.6) (44.5) x (104.0)	C1.5LG6	120 ft. 120 ft. 120 ft. 120 ft. 60 ft.	120 ft. 120 ft. 120 ft. 120 ft. 120 ft.	6 ft.
FS2X1 LG6NM FS2X1.5LG6NM FS2X2LG6NM FS2X3LG6NM FS2X4LG6NM FS2X5LG6NM	2.25 x 1.09 2.25 x 1.59 2.25 x 2.09 2.25 x 3.10 2.25 x 4.10 2.25 x 5.11	(57.2) x (27.1) (57.2) x (40.3) (57.2) x (53.0) (57.2) x (78.6) (57.2) x (104.0) (57.2) x (129.7)	C2LG6	120 ft. 120 ft. 120 ft. 60 ft. 60 ft. 60 ft.	120 ft. 120 ft. 120 ft. 120 ft. 120 ft. 120 ft.	6 ft.
✓ FS2.5X3LG6NM	2.75 x 3.12	(69.9) x (79.2)	C2.5LG6	60 ft.	120 ft.	6 ft.
FS3X1LG6NM FS3X2LG6NM FS3X3LG6NM FS3X4LG6NM FS3X5LG6NM	3.25 x 1.09 3.25 x 2.09 3.25 x 3.10 3.25 x 4.10 3.25 x 5.11	(82.6) x (27.6) (82.6) x (53.0) (82.6) x (78.6) (82.6) x (104.0) (82.6) x (129.7)	C3LG6	120 ft. 120 ft. 60 ft. 60 ft. 60 ft.	120 ft. 120 ft. 120 ft. 120 ft. 120 ft.	6 ft.
✓ FS4X1.5LG6NM ✓ FS4X2LG6NM ✓ FS4X3LG6NM ✓ FS4X4LG6NM ✓ FS4X5LG6NM	4.25 x 1.58 4.25 x 2.09 4.25 x 3.10 4.25 x 4.10 4.25 x 5.11	(108.0) x (40.0) (108.0) x (53.0) (108.0) x (78.6) (108.0) x (104.0) (108.0) x (129.7)	C4LG6	60 ft. 60 ft. 60 ft. 60 ft.	120 ft. 120 ft. 120 ft. 120 ft.	6 ft.
FS6X4LG6NM	6.25 x 4.11	(158.8) x (104.4)	C6LG6	60 ft.	120 ft.	6 ft.

\*Adhesive tape is not CSA Certified. See [page 30](#) for complete listing of dimensions. ✓=New Sizes

### Part Number Nomenclature —

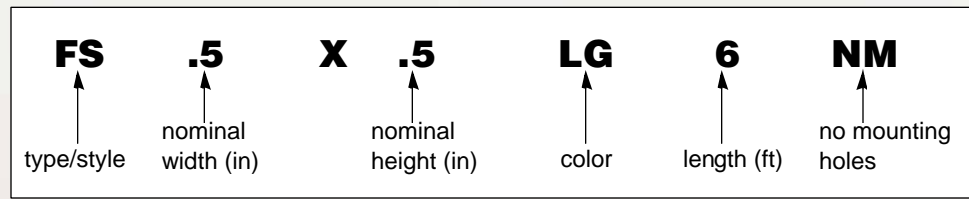



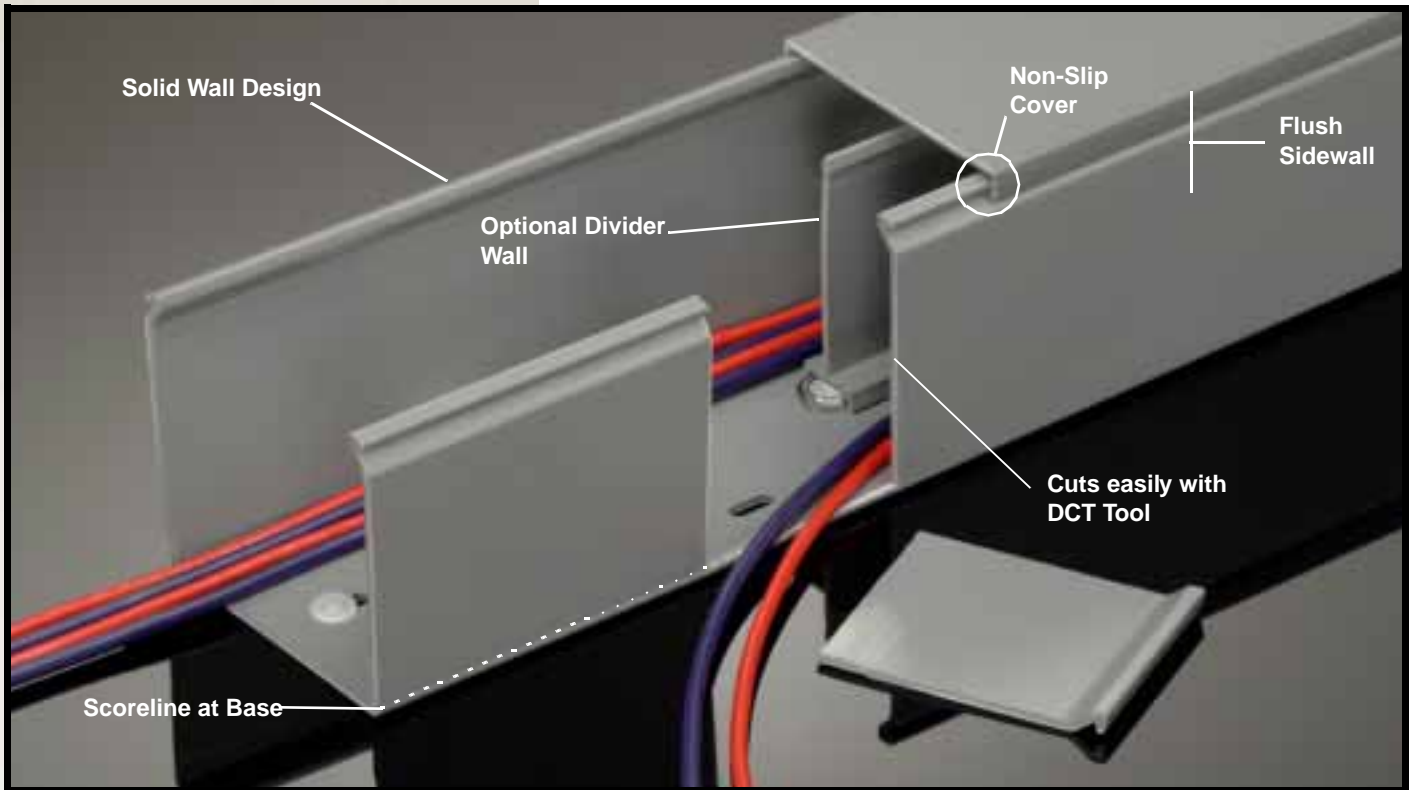

## Type FS Solid Wall Raceway

Choose from **34** sizes of Panduit Type FS Solid Wall Raceway from **.5"x.5'** up to **6"x4'**. The PVC material can be easily cut for breakouts and junctions. The non-slip cover keeps all wiring in place and is easy to install. The cover and base form a flush sidewall for increased capacity and improved aesthetics. It is excellent for use in non-plenum applications including under floor and telecommunication closet installations.

### Accessories

Duct Cutting Tool .....	23
Duct Finger Notching Tool .....	23
Nylon Rivet Installation Tool .....	23
Divider Walls.....	24
Wire Retainers .....	25
Optional Mounting Clip.....	27
Labeling .....	28

### Features & Benefits

#### Solid Walls

- Provide maximum wire protection

#### Flush Cover With Base

- Improves aesthetics

#### Larger Internal Area

- Provides greater wire capacity

#### Non-Slip Cover Design

- Incorporates integral high friction lining to inhibit cover movement

#### Optional Divider Wall

- Can create multiple channels within one duct to separate wiring

#### Easy Cover Installation and Removal

- Changes to wiring can be made quickly & easily

#### Scoreline at Base of Wall

- Allows for a breakout which is flush with base of the duct

#### Optional Mounting Holes

- Has same mounting hole pattern as Type F Duct

#### Bar Coded Part Number Label with QC Number

- Allows for automated inventory control systems
- Quick identification of loose piece duct
- Complete Quality Traceability

#### Optional Pressure-Sensitive Adhesive Mounting Tape

# PANDUCT® Type NE — Halogen Free Slotted Wall Wiring Duct



## Type NE — Halogen Free Slotted Wall Wiring Duct

- Made of Halogen free material (See [page 34](#) for material specifications)
- Rated for continuous use temperatures -40°C (-40°F) up to 95°C (203°F)
- Available in Light Gray and White color†
- Provided with standard mounting holes (dimensions see [pg. 31](#))
- Available without mounting holes (See ordering info below)
- Available with adhesive backing\* (See [page 22](#) for details)



### Type NE— Wiring Duct Standard Colors†:

LG	WH
Light Gray	White

Colors shown are approximate.

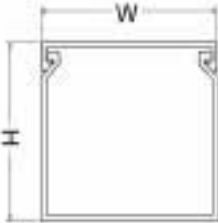

### Ordering Information:

- Order number of feet required in multiples of 6 ft or Std. Carton quantities.
- To order duct without mounting holes, add NM to Part Number.
- To order with pressure-sensitive adhesive mounting tape applied, add -A to Part Number.
- Part Number shown for Light Gray LG. To order other color, substitute WH White

†See [page 36](#) to determine which sizes are available in each color

Duct Part Number	Duct External Dimensions		Cover Part Number	Duct Std. Ctn. Qty.	Cover Std. Ctn. Qty.	Std. Lgth
	WxH IN.	WxH (mm)				
> NE.5X.5WH6 NE.5X.62LG6 NE.5X1LG6 NE.5X1.25LG6 NE.5X1.75LG6	0.63 x 0.56 0.63 x 0.68 0.63 x 1.06 0.63 x 1.31 0.63 x 1.81	(16.0) x (14.2) (16.0) x (17.3) (16.0) x (26.9) (16.0) x (33.3) (16.0) x (46.0)	NC.5LG6	120 ft. 120 ft. 120 ft. 120 ft. 120 ft.	120 ft. 120 ft. 120 ft. 120 ft. 120 ft.	6 ft.
NE1X1LG6 NE1X1.5LG6 NE1X2LG6 NE1X3LG6 NE1X4LG6	1.14 x 1.12 1.14 x 1.62 1.14 x 2.12 1.14 x 3.12 1.14 x 4.12	(29.0) x (28.4) (29.0) x (41.1) (29.0) x (53.8) (29.0) x (79.2) (29.0) x (104.6)	NC1LG6	120 ft. 120 ft. 120 ft. 120 ft. 120 ft.	120 ft. 120 ft. 120 ft. 120 ft. 120 ft.	6 ft.
> NE1.5X1WH6 NE1.5X1.5LG6 NE1.5X2LG6 NE1.5X3LG6 NE1.5X4LG6	1.64 x 1.12 1.64 x 1.62 1.64 x 2.12 1.64 x 3.12 1.64 x 4.12	(41.7) x (28.4) (41.7) x (41.1) (41.7) x (53.8) (41.7) x (79.2) (41.7) x (104.6)	NC1.5LG6	120 ft. 120 ft. 120 ft. 120 ft. 60 ft.	120 ft. 120 ft. 120 ft. 120 ft. 120 ft.	6 ft.
> NE2X1LG6 NE2X1.5WH6 NE2X2LG6 NE2X3LG6 NE2X4LG6	2.14 x 1.12 2.14 x 1.62 2.14 x 2.12 2.14 x 3.12 2.14 x 4.12	(54.4) x (28.4) (54.4) x (41.1) (54.4) x (53.8) (54.4) x (79.2) (54.4) x (104.6)	NC2LG6	120 ft. 120 ft. 120 ft. 60 ft. 60 ft.	120 ft. 120 ft. 120 ft. 120 ft. 120 ft.	6 ft.
NE2.5X3LG6	2.64 x 3.12	(67.1) x (79.2)	NC2.5LG6	60 ft.	120 ft.	6 ft.
NE3X1LG6 NE3X2LG6 NE3X3LG6 NE3X4LG6 NE3X5LG6	3.14 x 1.12 3.14 x 2.12 3.14 x 3.12 3.14 x 4.12 3.14 x 5.12	(79.8) x (28.4) (79.8) x (53.8) (79.8) x (79.2) (79.8) x (104.6) (79.8) x (130.0)	NC3LG6	120 ft. 120 ft. 60 ft. 60 ft. 60 ft.	120 ft. 120 ft. 120 ft. 120 ft. 120 ft.	6 ft.
NE4X2LG6 NE4X3LG6 NE4X4LG6 NE4X5LG6	4.14 x 2.12 4.14 x 3.12 4.14 x 4.12 4.14 x 5.12	(105.2) x (53.8) (105.2) x (79.2) (105.2) x (104.6) (105.2) x (130.0)	NC4LG6	60 ft. 60 ft. 60 ft. 60 ft.	120 ft. 120 ft. 120 ft. 120 ft.	6 ft.

NOTE: Avoid the use of screw tap and set fluids around "halogen free" material. These agents may cause material to become brittle.

\*Adhesive tape is not CSA Certified.

>Available as a standard part in WH color only.

See [page 31](#) for complete listing of dimensions.

### Part Number Nomenclature —

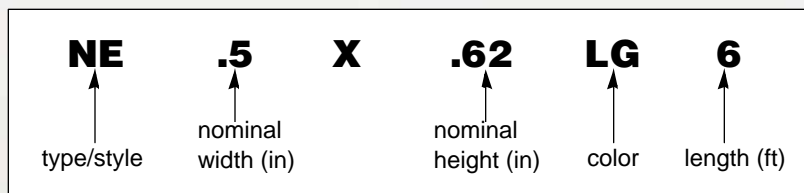



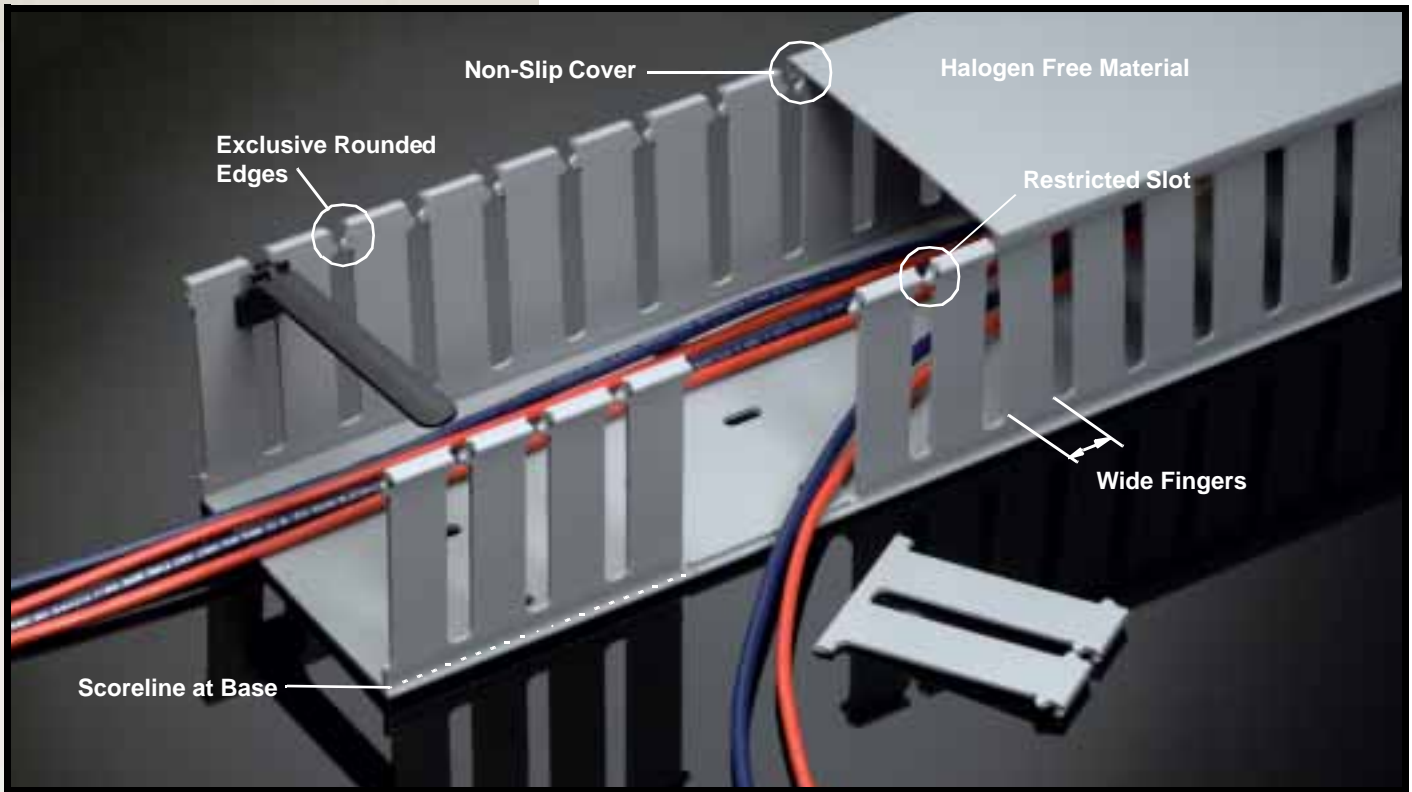

## Type NE Slotted Wall Wiring Duct

Choose from **30 sizes** of Panduit Type NE Halogen Free Slotted Wall Wiring Duct from **.5"x.5" up to 4"x5"**. The Halogen free material allows the duct to be used in higher temperature environments, to 95°C (203°F), and low temperature environments, to -40°C (-40°F). The non-slip cover keeps all wiring in place and is easy to install. The material can be easily cut for breakouts and junctions using the DCT and DNT tools.

### Accessories

Duct Cutting Tool .....	23
Duct Finger Notching Tool .....	23
Nylon Rivet Installation Tool .....	23
Wire Retainers .....	25
Optional Mounting Clip.....	27
Labeling .....	28

### Features & Benefits

#### Halogen Free Material

- Made of chlorine-free material for low halogen requirements

#### Increased Temperature Resistance

- Rated for temperatures from -40°C (-40°F) up to 95°C (203°F)

#### Restricted Slot Design

- Retains wire in slot
- Speeds installation
- Simply deflect finger for fast, easy wire installation or removal

#### Exclusive Rounded Edges Along Entire Slot

- Protect wires and hands from abrasion

#### Non-Slip Cover Design

- Incorporates integral high friction lining to inhibit cover movement

#### Easy Cover Removal

- Changes to wiring can be made quickly & easily

#### Bar Coded Part Number Label with QC Number

- Allows for automated inventory control systems
- Quick identification of loose piece duct
- Complete Quality Traceability

#### Optional Pressure-Sensitive Adhesive Mounting Tape

# PANDUCT® Type NS — Halogen Free Solid Wall Raceway

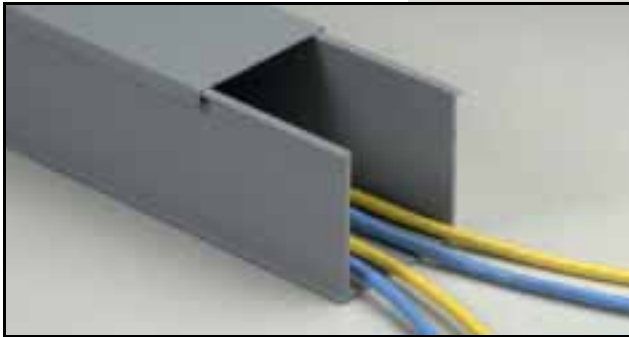

## Type NS—Halogen Free Solid Wall Raceway

- Made of Halogen free material (See [page 34](#) for material specifications)
- Rated for continuous use temperatures -40°C (-40°F) up to 95°C (203°F)
- Available in Light Gray and White color†
- Provided without standard mounting holes (dims see [pg. 31](#))
- Available with mounting holes (See ordering info below)
- Available with adhesive backing\* (See [page 22](#) for details)



### Type NS— Raceway Standard Colors†:

LG	WH
Light Gray	White

Colors shown are approximate.

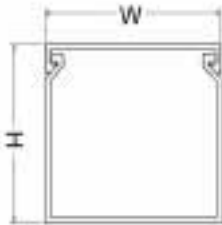

Raceway Part Number	Raceway External Dimensions		Cover Part Number	Raceway Std. Ctn. Qty.	Cover Std. Ctn. Qty.	Std. Lgth
	WxH IN.	WxH (mm)				
> NS.5X.5WH6NM NS.5X.62LG6NM NS.5X1LG6NM NS.5X1.25LG6NM NS.5X1.75LG6NM	0.63 x 0.56 0.63 x 0.68 0.63 x 1.06 0.63 x 1.31 0.63 x 1.81	(16.0) x (14.2) (16.0) x (17.3) (16.0) x (26.9) (16.0) x (33.3) (16.0) x (46.0)	NC.5LG6	120 ft. 120 ft. 120 ft. 120 ft. 120 ft.	120 ft. 120 ft. 120 ft. 120 ft. 120 ft.	6 ft.
NS1X1LG6NM NS1X1.5LG6NM NS1X2LG6NM NS1X3LG6NM NS1X4LG6NM	1.14 x 1.12 1.14 x 1.62 1.14 x 2.12 1.14 x 3.12 1.14 x 4.12	(29.0) x (28.4) (29.0) x (41.1) (29.0) x (53.8) (29.0) x (79.2) (29.0) x (104.6)	NC1LG6	120 ft. 120 ft. 120 ft. 120 ft. 120 ft.	120 ft. 120 ft. 120 ft. 120 ft. 120 ft.	6 ft.
> NS1.5X1WH6NM NS1.5X1.5LG6NM NS1.5X2LG6NM NS1.5X3LG6NM NS1.5X4LG6NM	1.64 x 1.12 1.64 x 1.62 1.64 x 2.12 1.64 x 3.12 1.64 x 4.12	(41.7) x (28.4) (41.7) x (41.1) (41.7) x (53.8) (41.7) x (79.2) (41.7) x (104.6)	NC1.5LG6	120 ft. 120 ft. 120 ft. 120 ft. 60 ft.	120 ft. 120 ft. 120 ft. 120 ft. 120 ft.	6 ft.
> NS2X1LG6NM NS2X1.5WH6NM NS2X2LG6NM NS2X3LG6NM NS2X4LG6NM	2.14 x 1.12 2.14 x 1.62 2.14 x 2.12 2.14 x 3.12 2.14 x 4.12	(54.4) x (28.4) (54.4) x (41.1) (54.4) x (53.8) (54.4) x (79.2) (54.4) x (104.6)	NC2LG6	120 ft. 120 ft. 120 ft. 60 ft. 60 ft.	120 ft. 120 ft. 120 ft. 120 ft. 120 ft.	6 ft.
NS2.5X3LG6NM	2.64 x 3.12	(67.1) x (79.2)	NC2.5LG6	60 ft.	120 ft.	6 ft.
NS3X1LG6NM NS3X2LG6NM NS3X3LG6NM NS3X4LG6NM NS3X5LG6NM	3.14 x 1.12 3.14 x 2.12 3.14 x 3.12 3.14 x 4.12 3.14 x 5.12	(79.8) x (28.4) (79.8) x (53.8) (79.8) x (79.2) (79.8) x (104.6) (79.8) x (130.0)	NC3LG6	120 ft. 120 ft. 60 ft. 60 ft. 60 ft.	120 ft. 120 ft. 120 ft. 120 ft. 120 ft.	6 ft.
NS4X2LG6NM NS4X3LG6NM NS4X4LG6NM NS4X5LG6NM	4.14 x 2.12 4.14 x 3.12 4.14 x 4.12 4.14 x 5.12	(105.2) x (53.8) (105.2) x (79.2) (105.2) x (104.6) (105.2) x (130.0)	NC4LG6	60 ft. 60 ft. 60 ft. 60 ft.	120 ft. 120 ft. 120 ft. 120 ft.	6 ft.

NOTE: Avoid the use of screw tap and set fluids around "halogen free" material. These agents may cause material to become brittle.

\*Adhesive tape is not CSA Certified.

>Available as a standard part in WH color only.

See [page 31](#) for complete listing of dimensions.

### Ordering Information:

- Order number of feet required in multiples of 6 ft or Std. Carton quantities.
- To order duct with mounting holes, delete NM to Part Number.
- To order with pressure-sensitive adhesive mounting tape applied, add -A to Part Number.
- Part Number shown for Light Gray LG. To order other color, substitute WH White

†See [page 36](#) to determine which sizes are available in each color

### Part Number Nomenclature —

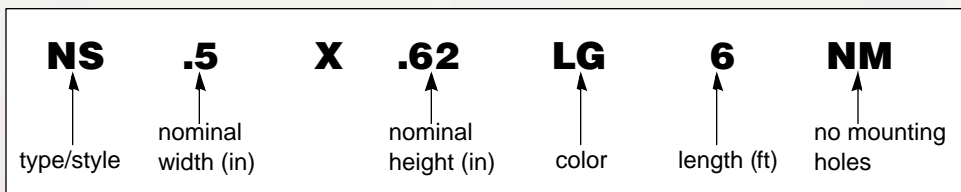



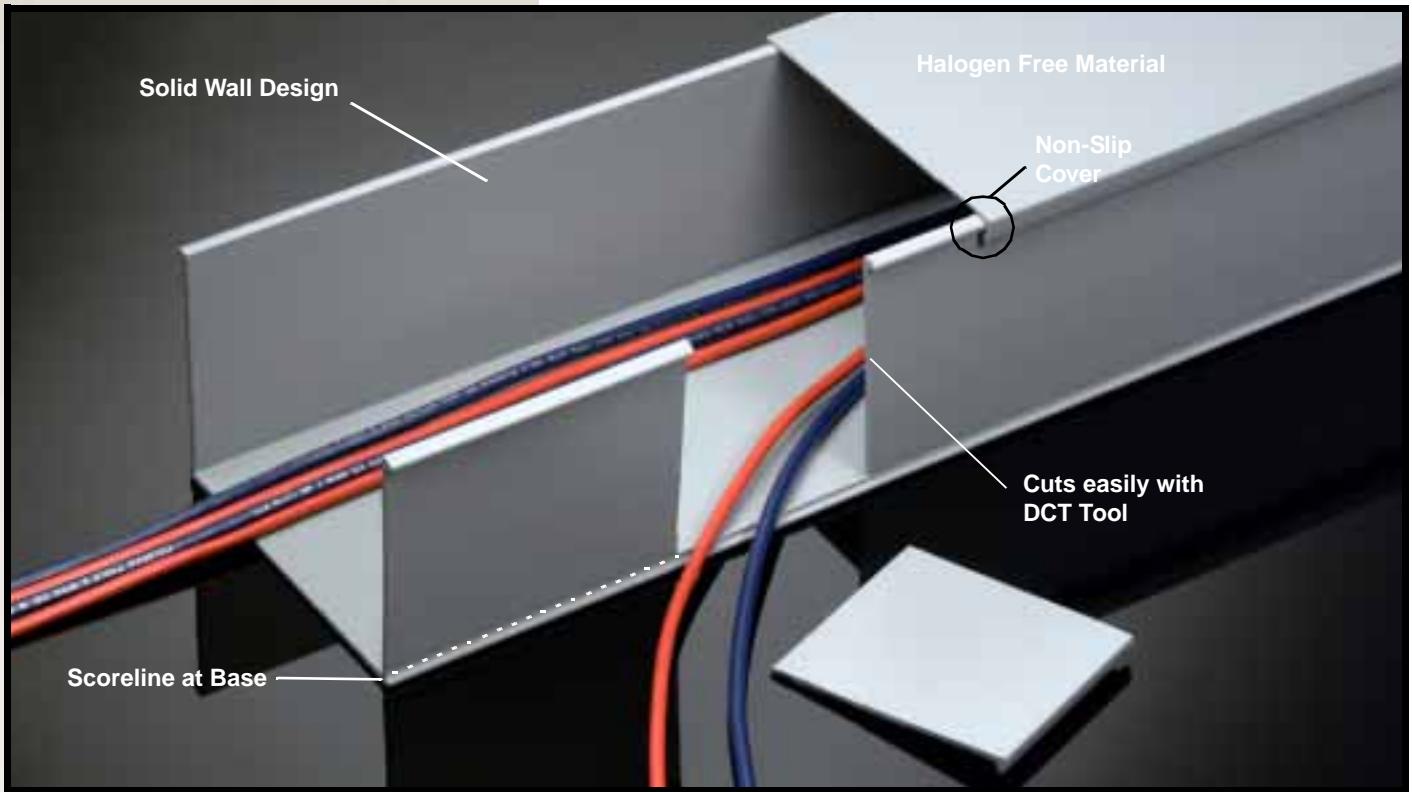

## Type NS Solid Wall Raceway

Choose from **30 sizes** of Panduit Type NS Halogen Free Solid Wall Raceway from **.5"x.5" up to 4"x5"**. The Halogen free material allows the duct to be used in higher temperature environments, to 95°C (203°F), and low temperature environments, to -40°C (-40°F). The non-slip cover keeps all wiring in place and is easy to install. The material can be easily cut for breakouts and junctions using the DCT and DNT tools.

### Accessories

Duct Cutting Tool .....	23
Duct Finger Notching Tool .....	23
Nylon Rivet Installation Tool .....	23
Wire Retainers .....	25
Optional Mounting Clip.....	27
Labeling .....	28

### Features & Benefits

#### Halogen Free Material

- Made of chlorine-free material for low halogen, requirements

#### Increased Temperature Resistance

- Rated for temperatures from -40°C (-40°F) up to 95°C (203°F)

#### Solid Walls

- Provide maximum wire protection

#### Non-Slip Cover Design

- Incorporates integral high friction lining to inhibit cover movement

#### Larger Internal Area

- Provides greater wire capacity

#### Easy Cover Installation and Removal

- Changes to wiring can be made quickly & easily

#### Bar Coded Part Number Label with QC Number

- Allows for automated inventory control systems
- Quick identification of loose piece duct
- Complete Quality Traceability

#### Optional Pressure-Sensitive Adhesive Mounting Tape

# PANDUCT® Type PE — Polycarbonate Slotted Wall Wiring Duct

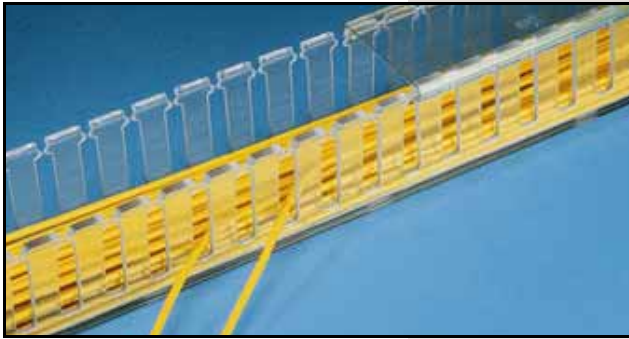

## Type PE—Polycarbonate Slotted Wall Wiring Duct

- Made of Polycarbonate material—for low halogen, low smoke applications (see [page 34](#) for material specifications)
- Rated for continuous use temperatures up to 125°C (257°F)
- Available in clear only
- Provided with standard mounting holes (dims see [pg. 31](#))
- Available without mounting holes (See ordering info below)
- Available with adhesive backing\* (See [page 22](#) for details)



### Type PE— Wiring Duct Standard Colors†:

CL
Clear

Duct Part Number	Duct External Dimensions		Cover Part Number	Std. Ctn. Qty.	Std. Ctn. Qty.	Std. Lgth
	WxH IN.	WxH (mm)				
PE.75X1CL6	0.88 x 1.06	(22.4) x (26.9)	PC.75CL6	120 ft.	120 ft.	6 ft.
> PE1X2CL6	1.14 x 2.12	(29.0) x (53.8)	PC1CL6	120 ft.	120 ft.	6 ft.
> PE1X3CL6	1.14 x 3.12	(29.0) x (79.2)	PC1CL6	120 ft.	120 ft.	6 ft.
PE1.5X1.5CL6	1.64 x 1.62	(41.7) x (41.1)	PC1.5CL6	120 ft.	120 ft.	6 ft.
PE2X1.5CL6	2.14 x 1.62	(54.4) x (41.1)	PC2CL6	120 ft.	120 ft.	6 ft.
PE2X2CL6	2.14 x 2.12	(54.4) x (53.8)				
PE3X1.25CL6	3.14 x 1.37	(79.8) x (34.8)	PC3CL6	120 ft.	120 ft.	6 ft.
PE4X4CL6	4.14 x 4.12	(105.2) x (104.6)	PC4CL6	60 ft.	120 ft.	6 ft.

Polycarbonate raceway is not UL Recognized or CSA Certified  
 >For availability contact factory.  
 \*Adhesive tape is not CSA Certified.  
 See [page 31](#) for complete listing of dimensions.

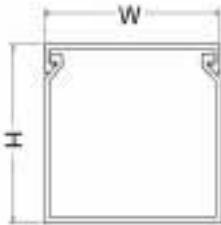

### Ordering Information:

- Order number of feet required in multiples of 6 ft or Std. Carton quantities.
- To order duct without mounting holes, add NM to Part Number.
- To order with pressure-sensitive adhesive mounting tape applied, add -A to Part Number.
- Part Number shown for CL Clear

†Available in Clear only

### Part Number Nomenclature —

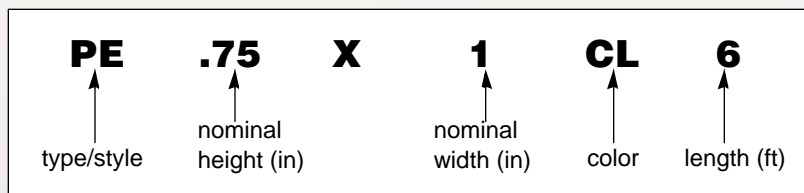



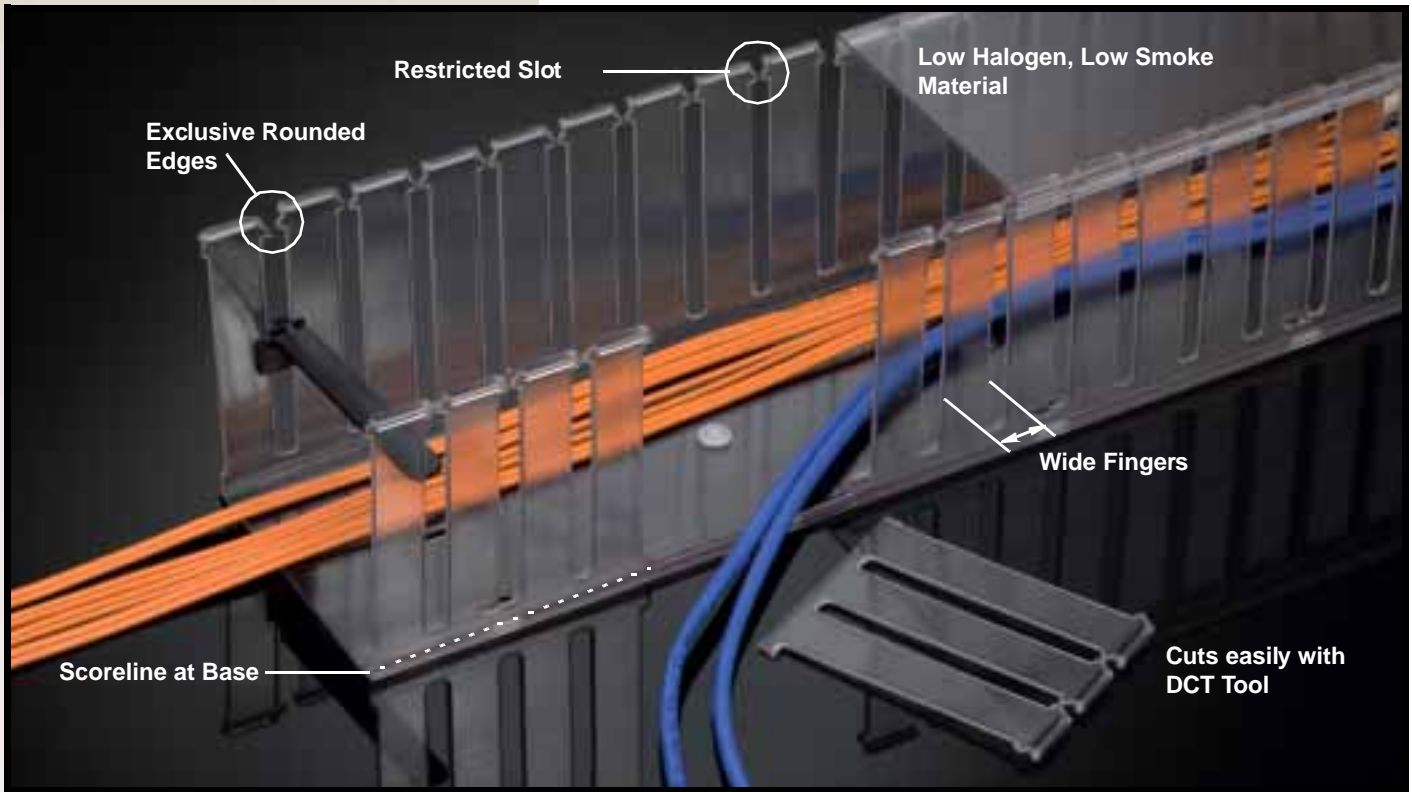

## Type PE Polycarbonate Slotted Wall Duct

Choose from **8** sizes of Panduit Type PE Polycarbonate Slotted Wall Wiring Duct from **.75"x1" up to 4"x4"**. The low halogen, low smoke Polycarbonate material allows the duct to be used in higher temperature environments, up to 125°C (257°F), and low temperature environments, to -40°C (-40°F). The material can be easily cut for breakouts and junctions using the DCT and DNT tools.

### Accessories

Duct Cutting Tool .....	23
Duct Finger Notching Tool .....	23
Nylon Rivet Installation Tool .....	23
Divider Walls.....	24
Wire Retainers.....	25
Optional Mounting Clip.....	27
Labeling .....	28

### Features & Benefits

#### Low Halogen, Low Smoke Material

- Made from low halogen, low smoke Polycarbonate material

#### Increased Temperature Resistance

- Rated for temperatures from -40°C (-40°F) up to 125°C (257°F)

#### Restricted Slot Design

- Retains wire in slot
- Speeds installation
- Simply deflect finger for fast, easy wire installation or removal

#### Exclusive Rounded Edges Along Entire Slot

- Protect wires and hands from abrasion

#### Optional Divider Wall

- Can create multiple channels within one duct to separate wiring

#### Easy Cover Removal

- Changes to wiring can be made quickly & easily

#### Bar Coded Part Number Label with QC Number

- Allows for automated inventory control systems
- Quick identification of loose piece duct
- Complete Quality Traceability

#### Optional Pressure-Sensitive Adhesive Mounting Tape

# PANDUCT® Type PS — Polycarbonate Solid Wall Raceway



## Type PS—Polycarbonate Solid Wall Raceway

- Made of Polycarbonate material—for low halogen, low smoke applications (see [page 34](#) for material specifications)
- Rated for continuous use temperatures up to 125°C (257°F)
- Available in clear only
- Provided with standard mounting holes (dims see [pg. 31](#))
- Available without mounting holes (See ordering info below)
- Available with adhesive backing\* (See [page 22](#) for details)



### Type PS— Raceway Standard Colors†:

CL
Clear

Raceway Part Number	Raceway External Dimensions		Cover Part Number	Raceway Std. Ctn. Qty.	Cover Std. Ctn. Qty.	Std. Lgth
	WxH IN.	WxH (mm)				
PS.75X1CL6NM	0.88 x 1.06	(22.4) x(26.9)	PC.75CL6	120 ft.	120 ft.	6 ft.
PS1.5X1.5CL6NM	1.64 x 1.62	(41.7) x(41.1)	PC1.5CL6	120 ft.	120 ft.	6 ft.
PS2X1.5CL6NM PS2X2CL6NM	2.14 x 1.62 2.14 x 2.12	(54.4) x(41.1) (54.4) x(53.8)	PC2CL6	120 ft.	120 ft.	6 ft.
PS3X1.25CL6NM	3.14 x 1.37	(79.8) x(34.8)	PC3CL6	120 ft.	120 ft.	6 ft.
PS4X4CL6NM	4.14 x 4.12	(105.2) x(104.6)	PC4CL6	60 ft.	120 ft.	6 ft.

Polycarbonate raceway is not UL Recognized or CSA Certified

\*Adhesive tape is not CSA Certified.

See [page 31](#) for complete listing of dimensions.

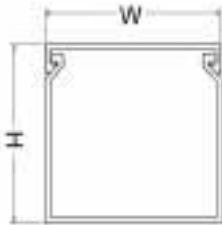

### Ordering Information:

- Order number of feet required in multiples of 6 ft or Std. Carton quantities.
- To order with mounting holes, delete NM to Part Number.
- To order with pressure-sensitive adhesive mounting tape applied, add -A to Part Number.
- Part Number shown for CL Clear

†Available in Clear only.

### Part Number Nomenclature —

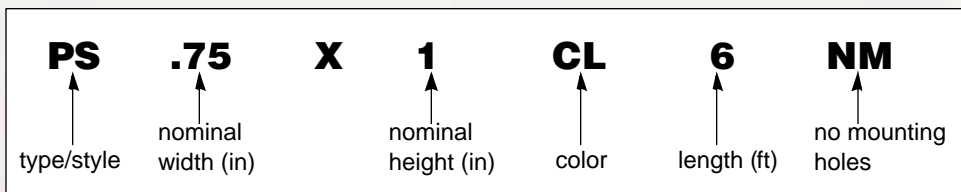





## Type PS Polycarbonate Solid Wall Raceway

Choose from **6** sizes of Panduit Type PS Polycarbonate Solid Wall Raceway from **.75"x1" up to 4"x4"**. The low halogen, low smoke Polycarbonate material allows the raceway to be used in higher temperature environments, up to 125°C (257°F), and low temperature environments, to -40°C (-40°F). The material can be easily cut for breakouts and junctions using the DCT and DNT tools.

### Accessories

Duct Cutting Tool .....	23
Duct Finger Notching Tool .....	23
Nylon Rivet Installation Tool .....	23
Divider Walls.....	24
Wire Retainers.....	25
Optional Mounting Clip.....	27
Labeling .....	28

### Features & Benefits

#### Low Halogen, Low Smoke Material

- Made from low halogen, low smoke Polycarbonate material

#### Increased Temperature Resistance

- Rated for temperatures up to 125°C (257°F)

#### Solid Walls

- Provide maximum wire protection

#### Larger Internal Area

- Provides greater wire capacity

#### Optional Divider Wall

- Can create multiple channels within one duct to separate wiring

#### Easy Cover Installation and Removal

- Changes to wiring can be made quickly & easily

#### Bar Coded Part Number Label with QC Number

- Allows for automated inventory control systems

- Quick identification of loose piece duct
- Complete Quality Traceability

#### Optional Pressure-Sensitive Adhesive Mounting Tape

# PANDUCT® Type D — Round Hole Wiring Duct

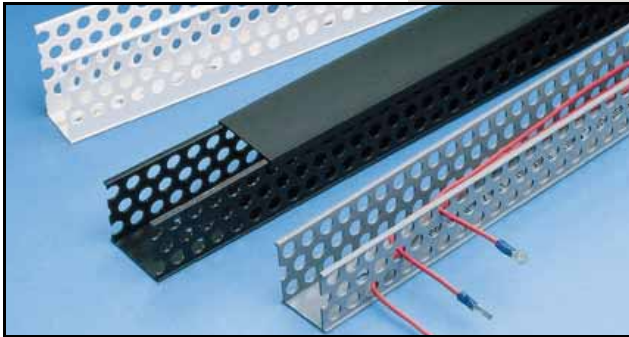



## Type D Round Hole Wiring Duct

- Made of rigid PVC (See [pg. 34](#) for material specifications)
- Rated for continuous use temperatures up to 50°C (122°F)
- U.L. Flammability Rating: V-0
- Available in Light Gray (LG), White (WH) or Black (BL)
- Provided with standard mounting holes (dimensions see [pg. 31](#))
- Available without mounting holes (See ordering information below)
- Available with adhesive backing\* (See [page 22](#) for details)

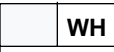

**Type D— Wiring Duct Standard Colors†:**

	<b>LG</b>		<b>WH</b>		<b>BL</b>
Light Gray		White		Black	

Colors shown are approximate.

Duct Part Number	Duct External Dimensions		Cover Part Number	Duct Std. Ctn. Qty.	Cover Std. Ctn. Qty.	Std. Lgth
	WxH IN.	WxH (mm)				
D.75X.75LG6 D.75X1.1LG6 D.75X1.5LG6	0.88 x 0.81 0.88 x 1.06 0.88 x 1.56	(22.4) x (20.6) (22.4) x (26.9) (22.4) x (39.6)	C.75LG6	120 ft. 120 ft. 120 ft.	120 ft. 120 ft. 120 ft.	6 ft.
D1X1LG6 D1X1.5LG6 D1X2LG6 D1X3LG6 D1X4LG6	1.14 x 1.12 1.14 x 1.62 1.14 x 2.12 1.14 x 3.12 1.14 x 4.12	(29.0) x (28.4) (29.0) x (41.1) (29.0) x (53.8) (29.0) x (79.2) (29.0) x (104.6)	C1LG6	120 ft. 120 ft. 120 ft. 120 ft. 120 ft.	120 ft. 120 ft. 120 ft. 120 ft. 120 ft.	6 ft.
D1.5X1.5LG6 D1.5X2LG6 D1.5X3LG6 D1.5X4LG6	1.64 x 1.62 1.64 x 2.12 1.64 x 3.12 1.64 x 4.12	(41.7) x (41.1) (41.7) x (53.8) (41.7) x (79.2) (41.7) x (104.6)	C1.5LG6	120 ft. 120 ft. 120 ft. 60 ft.	120 ft. 120 ft. 120 ft. 120 ft.	6 ft.
D2X1 LG6 D2X2LG6 D2X3LG6 D2X4LG6	2.14 x 1.12 2.14 x 2.12 2.14 x 3.12 2.14 x 4.12	(54.4) x (28.4) (54.4) x (53.8) (54.4) x (79.2) (54.4) x (104.6)	C2LG6	120 ft. 120 ft. 60 ft. 60 ft.	120 ft. 120 ft. 120 ft. 120 ft.	6 ft.
D2.5X3LG6	2.64 x 3.12	(67.1) x (79.2)	C2.5LG6	60 ft.	120 ft.	6 ft.
D3X1 LG6 D3X1.25LG6 D3X2LG6 D3X3LG6 D3X4LG6	3.14 x 1.12 3.14 x 1.37 3.14 x 2.12 3.14 x 3.12 3.14 x 4.12	(79.8) x (28.4) (79.8) x (34.8) (79.8) x (53.8) (79.8) x (79.2) (79.8) x (104.6)	C3LG6	120 ft. 120 ft. 120 ft. 60 ft. 60 ft.	120 ft. 120 ft. 120 ft. 120 ft. 120 ft.	6 ft.
D4X1.5LG6 D4X2LG6 D4X3LG6 D4X4LG6	4.14 x 1.62 4.14 x 2.12 4.14 x 3.12 4.14 x 4.12	(105.2) x (41.1) (105.2) x (53.8) (105.2) x (79.2) (105.2) x (104.6)	C4LG6	120 ft. 60 ft. 60 ft. 60 ft.	120 ft. 120 ft. 120 ft. 120 ft.	6 ft.

\*Adhesive tape is not CSA Certified.  
See [page 31](#) for complete listing of dimensions.

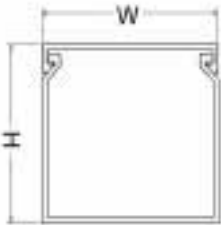

### Ordering Information:

- Order number of feet required in multiples of 6 ft or Std. Carton quantities.
- To order duct without mounting holes, add NM to Part Number.
- To order with pressure-sensitive adhesive mounting tape applied, add -A to Part Number.
- Part Number shown for Light Gray LG. To order other colors, substitute WH White, and BL Black

†See [page 36](#) to determine which sizes are available in each color

### Part Number Nomenclature —

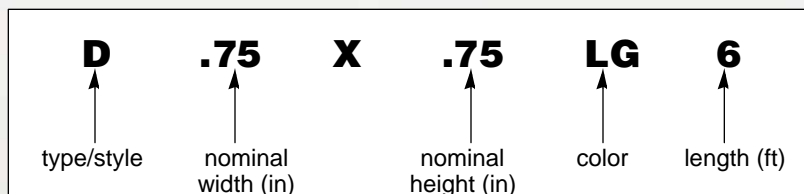

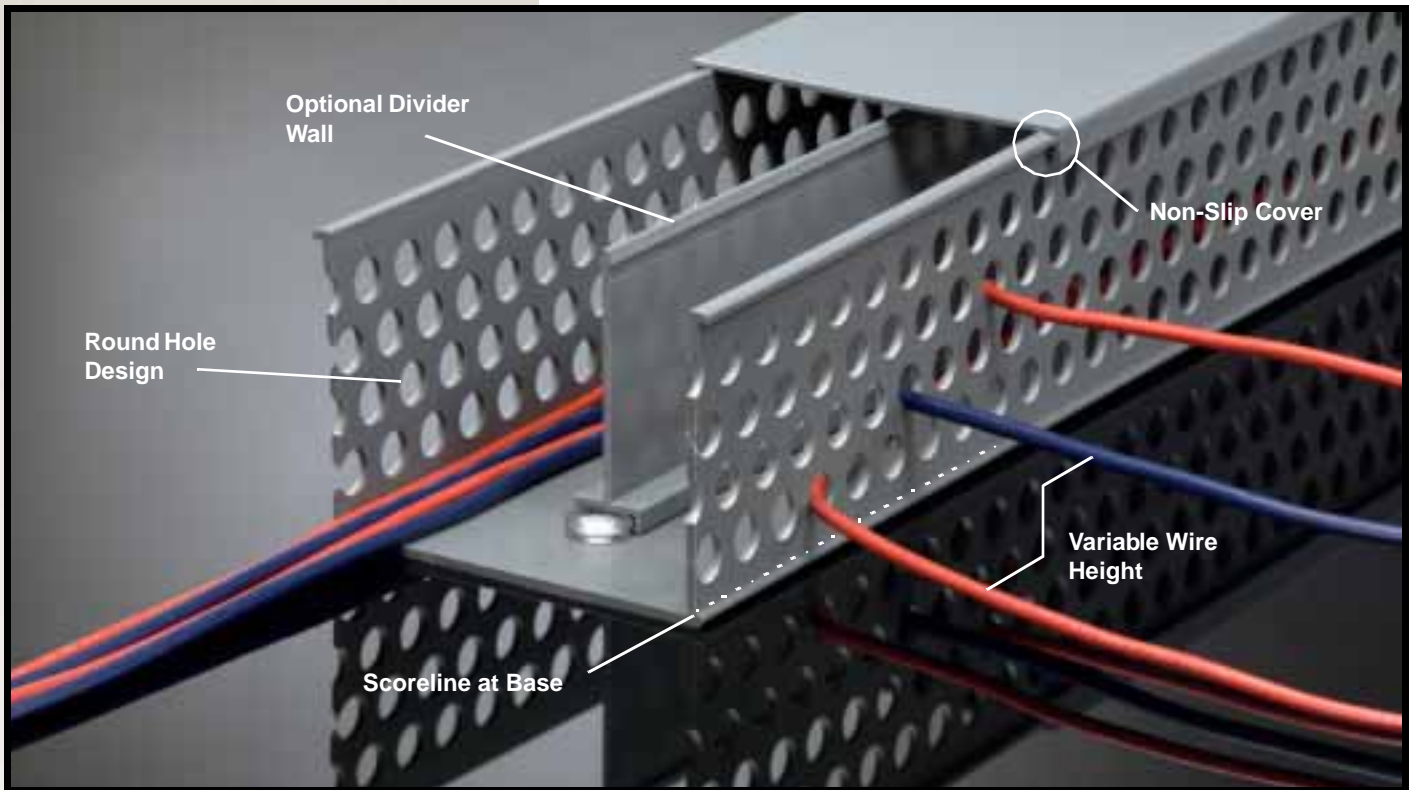

## Type D Round Hole Wiring Duct

Choose from **26** sizes of Type D Round Hole Wiring Duct from **.75" X .75" up to 4" X 4"**. The round holes are designed to keep wires exiting the duct at a certain height. The non-slip cover snaps onto the duct to conceal the wiring and improve the appearance of your control panel.

### Accessories

Duct Cutting Tool .....	23
Duct Finger Notching Tool .....	23
Nylon Rivet Installation Tool .....	23
Divider Walls.....	24
Optional Mounting Clip.....	27
Labeling .....	28

### Features & Benefits

#### Round Hole Design

- Maintains wires at a certain height
- Provides added support

#### Easy Cover Installation and Removal

- Changes to wiring can be made quickly & easily

#### Optional Divider Wall

- Can create multiple channels within one duct to separate wiring

#### Smooth Rounded Edges

- Protect wires and hands from abrasion

#### Elongated Mounting Holes

- Allows greater mounting flexibility

#### Non-Slip Cover Design

- Incorporates integral high friction lining to inhibit cover movement

#### Scoreline at Base of Wall

- Allows for breakout which is flush with base of duct

#### Bar Coded Part Number Label with QC Number

- Allows for automated inventory control systems
- Quick identification of loose piece duct
- Complete Quality Traceability

#### Optional Pressure-Sensitive Adhesive Mounting Tape



# PANDUCT® Type E — Slotted Wall Wiring Duct

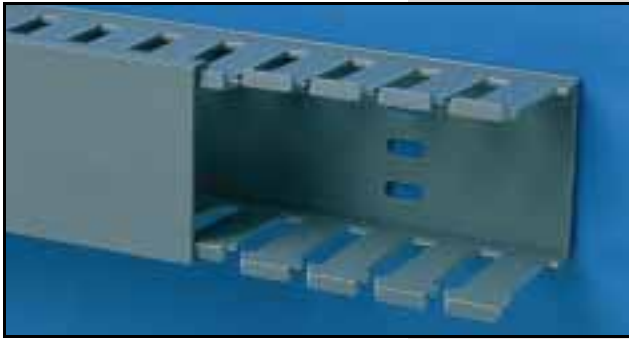





## Type E Slotted Wall Wiring Duct

- Made of rigid PVC (See [pg. 34](#) for material specifications)
- Rated for continuous use temperatures up to 50°C (122°F)
- Available in a variety of colors as a standard part (See [page 36](#) for details)
- Provided with standard mounting holes (dimensions [page 31](#))
- Available without mounting holes (See ordering information below)
- Available with adhesive backing\* (See [page 22](#) for details)

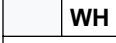

### Type E— Wiring Duct Standard Colors†:

	<b>LG</b>		<b>DG</b>		<b>WH</b>
Light Gray		Dark Gray		White	
	<b>BL</b>		<b>IB</b>		
Black		Intrinsic Blue			

Colors shown are approximate.

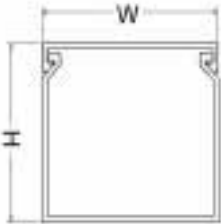

Duct Part Number	Duct External Dimensions		Cover Part Number	Duct Std. Ctn. Qty.	Cover Std. Ctn. Qty.	Std. Lgth
	WxH IN.	WxH (mm)				
E.5X.5LG6 E.5X.62LG6 E.5X1LG6 E.5X1.25LG6 E.5X1.75LG6 E.5X2LG6	0.63 x 0.56 0.63 x 0.68 0.63 x 1.06 0.63 x 1.31 0.63 x 1.81 0.63 x 2.06	(16.0) x (14.2) (16.0) x (17.3) (16.0) x (26.9) (16.0) x (33.3) (16.0) x (46.0) (16.0) x (52.3)	<b>C.5LG6</b>	120 ft. 120 ft. 120 ft. 120 ft. 120 ft. 120 ft.	120 ft. 120 ft. 120 ft. 120 ft. 120 ft. 120 ft.	6 ft.
E.75X.75LG6 E.75X1LG6 E.75X1.5LG6 E.75X2LG6	0.88 x 0.81 0.88 x 1.06 0.88 x 1.56 0.88 x 2.12	(22.4) x (20.6) (22.4) x (26.9) (22.4) x (39.6) (22.4) x (53.8)	<b>C.75LG6</b>	120 ft. 120 ft. 120 ft. 120 ft.	120 ft. 120 ft. 120 ft. 120 ft.	6 ft.
E1X1LG6 E1X1.25LG6 E1X1.5LG6 E1X2LG6 E1X2.5LG6 E1X3LG6 E1X4LG6	1.14 x 1.12 1.14 x 1.37 1.14 x 1.62 1.14 x 2.12 1.14 x 2.62 1.14 x 3.12 1.14 x 4.12	(29.0) x (28.4) (29.0) x (34.8) (29.0) x (41.1) (29.0) x (53.8) (29.0) x (66.5) (29.0) x (79.2) (29.0) x (104.6)	<b>C1LG6</b>	120 ft. 120 ft. 120 ft. 120 ft. 120 ft. 120 ft. 120 ft.	120 ft. 120 ft. 120 ft. 120 ft. 120 ft. 120 ft. 120 ft.	6 ft.
E1.5X1 LG6 E1.5X1.5LG6 E1.5X2LG6 E1.5X3LG6 E1.5X4LG6	1.64 x 1.12 1.64 x 1.62 1.64 x 2.12 1.64 x 3.12 1.64 x 4.12	(41.7) x (28.4) (41.7) x (41.1) (41.7) x (53.8) (41.7) x (79.2) (41.7) x (104.6)	<b>C1.5LG6</b>	120 ft. 120 ft. 120 ft. 120 ft. 60 ft.	120 ft. 120 ft. 120 ft. 120 ft. 120 ft.	6 ft.
E2X1LG6 E2X1.5LG6 E2X2LG6 E2X2.5LG6 E2X3LG6 E2X4LG6 E2X5LG6	2.14 x 1.12 2.14 x 1.62 2.14 x 2.12 2.14 x 2.62 2.14 x 3.12 2.14 x 4.12 2.14 x 5.12	(54.4) x (28.4) (54.4) x (41.1) (54.4) x (53.8) (54.4) x (66.5) (54.4) x (79.2) (54.4) x (104.6) (54.4) x (130.0)	<b>C2LG6</b>	120 ft. 120 ft. 120 ft. 60 ft. 60 ft. 60 ft. 60 ft.	120 ft. 120 ft. 120 ft. 120 ft. 120 ft. 120 ft. 120 ft.	6 ft.
E2.5X3LG6	2.64 x 3.12	(67.1) x (79.2)	<b>C2.5LG6</b>	60 ft.	120 ft.	6 ft.
E3X1LG6 E3X1.25LG6 E3X2LG6 E3X3LG6 E3X4LG6 E3X5LG6	3.14 x 1.12 3.14 x 1.37 3.14 x 2.12 3.14 x 3.12 3.14 x 4.12 3.14 x 5.12	(79.8) x (28.4) (79.8) x (34.8) (79.8) x (53.8) (79.8) x (79.2) (79.8) x (104.6) (79.8) x (130.0)	<b>C3LG6</b>	120 ft. 120 ft. 60 ft. 60 ft. 60 ft. 60 ft.	120 ft. 120 ft. 120 ft. 120 ft. 120 ft. 120 ft.	6 ft.
E4X1.5LG6 E4X2LG6 E4X3LG6 E4X4LG6 E4X5LG6	4.14 x 1.62 4.14 x 2.12 4.14 x 3.12 4.14 x 4.12 4.14 x 5.12	(105.2) x (41.1) (105.2) x (53.8) (105.2) x (79.2) (105.2) x (104.6) (105.2) x (130.0)	<b>C4LG6</b>	120 ft. 60 ft. 60 ft. 60 ft. 60 ft.	120 ft. 120 ft. 120 ft. 120 ft. 120 ft.	6 ft.

See [page 31](#) for complete listing of dimensions. \*Adhesive tape is not CSA Certified.

### Ordering Information:

- Order number of feet required in multiples of 6 ft or Std. Carton quantities.
- To order duct without mounting holes, add NM to Part Number.
- To order with pressure-sensitive adhesive mounting tape applied, add -A to Part Number.
- Part Number shown for Light Gray LG. To order other colors, substitute WH White, DG Dark Gray, BL Black, and IB Intrinsic Blue

†See [page 36](#) to determine which sizes are available in each color

### Part Number Nomenclature —

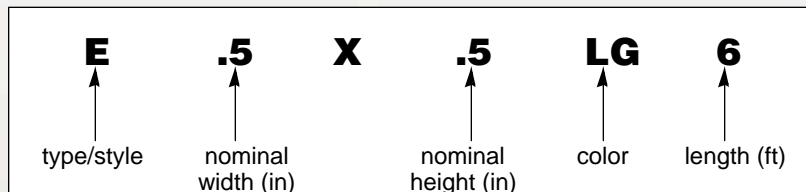

# PANDUCT® Type S — Solid Wall Raceway



## Type S Solid Wall Raceway

- Made of rigid PVC (See [pg. 34](#) for material specifications)
- Rated for continuous use temperatures up to 50°C (122°F)
- Available in a variety of colors as a standard part (See [page 36](#) for details)
- Provided with standard mounting holes (dimensions [page 31](#))
- Available without mounting holes (See ordering information below)
- Available with adhesive backing\* (See [page 22](#) for details)



### Type S— Raceway Standard Colors†:

	LG		DG		WH
Light Gray		Dark Gray		White	
	BL		IB		
Black		Intrinsic Blue			

Colors shown are approximate.

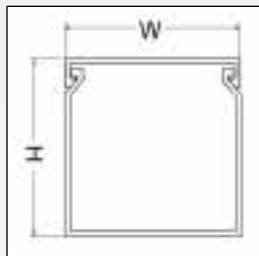

Raceway Part Number	Raceway External Dimensions		Cover Part Number	Raceway Std. Ctn. Qty.	Cover Std. Ctn. Qty.	Std. Lgth
	WxH IN.	WxH (mm)				
S.5X.5LG6NM S.5X.62LG6NM S.5X1LG6NM S.5X1.25LG6NM S.5X1.75LG6NM S.5X2LG6NM	0.63 x 0.56 0.63 x 0.68 0.63 x 1.06 0.63 x 1.31 0.63 x 1.81 0.63 x 2.06	(16.0) x (14.2) (16.0) x (17.3) (16.0) x (26.9) (16.0) x (33.3) (16.0) x (46.0) (16.0) x (52.3)	C.5LG6	120 ft. 120 ft. 120 ft. 120 ft. 120 ft. 120 ft.	120 ft. 120 ft. 120 ft. 120 ft. 120 ft. 120 ft.	6 ft.
S.75X.75LG6NM S.75X1LG6NM S.75X1.5LG6NM S.75X2LG6NM	0.88 x 0.81 0.88 x 1.06 0.88 x 1.56 0.88 x 2.12	(22.4) x (20.6) (22.4) x (26.9) (22.4) x (39.6) (22.4) x (53.8)	C.75LG6	120 ft. 120 ft. 120 ft. 120 ft.	120 ft. 120 ft. 120 ft. 120 ft.	6 ft.
S1X1LG6NM S1X1.25LG6NM S1X1.5LG6NM S1X2LG6NM S1X2.5LG6NM S1X3LG6NM S1X4LG6NM	1.14 x 1.12 1.14 x 1.37 1.14 x 1.62 1.14 x 2.12 1.14 x 2.62 1.14 x 3.12 1.14 x 4.12	(29.0) x (28.4) (29.0) x (34.8) (29.0) x (41.1) (29.0) x (53.8) (29.0) x (66.5) (29.0) x (79.2) (29.0) x (104.6)	C1LG6	120 ft. 120 ft. 120 ft. 120 ft. 120 ft. 120 ft. 120 ft.	120 ft. 120 ft. 120 ft. 120 ft. 120 ft. 120 ft. 120 ft.	6 ft.
S1.5X1 LG6NM S1.5X1.5LG6NM S1.5X2LG6NM S1.5X3LG6NM S1.5X4LG6NM	1.64 x 1.12 1.64 x 1.62 1.64 x 2.12 1.64 x 3.12 1.64 x 4.12	(41.7) x (28.4) (41.7) x (41.1) (41.7) x (53.8) (41.7) x (79.2) (41.7) x (104.6)	C1.5LG6	120 ft. 120 ft. 120 ft. 120 ft. 60 ft.	120 ft. 120 ft. 120 ft. 120 ft. 120 ft.	6 ft.
S2X1LG6NM S2X1.5LG6NM S2X2LG6NM S2X2.5LG6NM S2X3LG6NM S2X4LG6NM S2X5LG6NM	2.14 x 1.12 2.14 x 1.62 2.14 x 2.12 2.14 x 2.62 2.14 x 3.12 2.14 x 4.12 2.14 x 5.12	(54.4) x (28.4) (54.4) x (41.1) (54.4) x (53.8) (54.4) x (66.5) (54.4) x (79.2) (54.4) x (104.6) (54.4) x (130.0)	C2LG6	120 ft. 120 ft. 120 ft. 60 ft. 60 ft. 60 ft. 60 ft.	120 ft. 120 ft. 120 ft. 120 ft. 120 ft. 120 ft. 120 ft.	6 ft.
S2.5X3LG6NM	2.64 x 3.12	(67.1) x (79.2)	C2.5LG6	60 ft.	120 ft.	6 ft.
S3X1LG6NM S3X1.25LG6NM S3X2LG6NM S3X3LG6NM S3X4LG6NM S3X5LG6NM	3.14 x 1.12 3.14 x 1.37 3.14 x 2.12 3.14 x 3.12 3.14 x 4.12 3.14 x 5.12	(79.8) x (28.4) (79.8) x (34.8) (79.8) x (53.8) (79.8) x (79.2) (79.8) x (104.6) (79.8) x (130.0)	C3LG6	120 ft. 120 ft. 60 ft. 60 ft. 60 ft. 60 ft.	120 ft. 120 ft. 120 ft. 120 ft. 120 ft. 120 ft.	6 ft.
S4X1.5LG6NM S4X2LG6NM S4X3LG6NM S4X4LG6NM S4X5LG6NM	4.14 x 1.62 4.14 x 2.12 4.14 x 3.12 4.14 x 4.12 4.14 x 5.12	(105.2) x (41.1) (105.2) x (53.8) (105.2) x (79.2) (105.2) x (104.6) (105.2) x (130.0)	C4LG6	120 ft. 60 ft. 60 ft. 60 ft. 60 ft.	120 ft. 120 ft. 120 ft. 120 ft. 120 ft.	6 ft.

See [page 31](#) for complete listing of dimensions. \*Adhesive tape is not CSA Certified.

### Ordering Information:

- Order number of feet required in multiples of 6 ft or Std. Carton quantities.
- To order duct with mounting holes, delete NM from Part Number.
- To order with pressure-sensitive adhesive mounting tape applied, add -A to Part Number.
- Part Number shown for Light Gray LG. To order other colors, substitute WH for White, DG for Dark Gray, BL for Black, and IB for Intrinsic Blue

†See [page 36](#) to determine which sizes are available in each color

### Part Number Nomenclature —

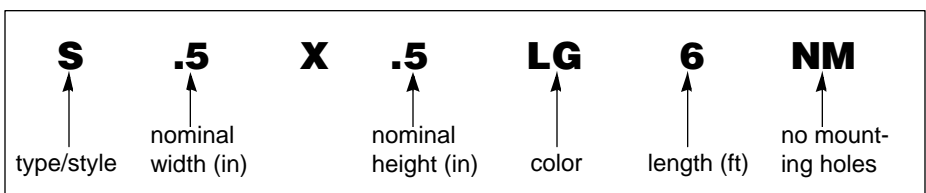

# PANDUCT® Adhesive Backed Wiring Duct



## Adhesive Backed Wiring Duct

### For All Wiring Duct Types and Sizes

Adhesive backing is an available option for all types and sizes of **PANDUIT** Wiring Duct and Raceway. The adhesive backing is factory applied and ready for use. Simply peel off the tape's protective liner and mount the duct to a clean, dry, grease-free surface.

### Features & Benefits

#### As a PERMANENT MOUNTING METHOD

Eliminates the drilling and tapping of holes, labor and time required to install separate mounting devices.

#### As a TEMPORARY MOUNTING METHOD

Holds duct in place to free installer's hands to further secure duct with screws, rivets, etc.

- Recommended installation temperature is 70°F (21°C)
- UL Recognized service temperature is 32°F (0°C) to 140°F (60°C)
- Optimum recommended dwell time for acrylic adhesive is 8 hours
- Recommended tape load is 1/2 lb. per square inch of tape area

### Factory Applied Tape —

To order any Panduit Wiring Duct or Raceway with pressure-sensitive adhesive mounting tape factory applied add -A to the Duct/Raceway part

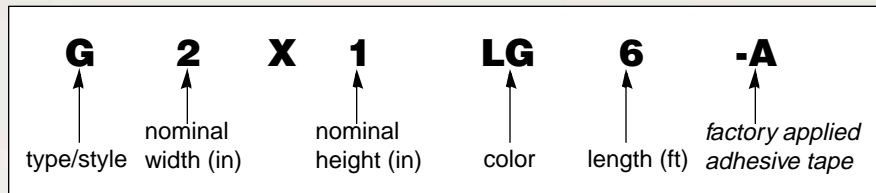

### Material Specifications Table for Factory Applied Tape:

DUCT SIZE WxH	ROWS OF TAPE	TAPE			
		WIDTH		THICKNESS	
		In.	(mm)	In.	(mm)
.5X.5 thru 1.5X4	1	.50	(12.7)	.0313	(.8)
2X1 thru 3X3	2	.50	(12.7)	.0313	(.8)
3X4 thru 3X5	2	.75	(19.1)	.0313	(.8)
4X1.5 thru 4X3	2	.50	(12.7)	.0313	(.8)
4X4 thru 6X4	2	.75	(19.1)	.0313	(.8)

### To Order Tape Separately:

DUCT SIZE WxH	TAPE PART NUMBER	ROLL LENGTH		STD PKG QTY	STD CTN QTY
		Yds.	(m)		
.5X.5 thru 1.5X4	P32W2A2-50-7	7.0	(6.4)	1 Roll	100 Rolls
	P32W2A2-50-72	72.0	(65.5)	1 Roll	9 Rolls
2X1 thru 3X3	P32W2A2-50-7	7.0	(6.4)	1 Roll	100 Rolls
	P32W2A2-50-72	72.0	(65.5)	1 Roll	9 Rolls
3X4 thru 3X5	P32W2A2-75-7	7.0	(6.4)	1 Roll	60 Rolls
	P32W2A2-75-72	72.0	(65.5)	1 Roll	7 Rolls
4X1.5 thru 4X3	P32W2A2-50-7	7.0	(6.4)	1 Roll	100 Rolls
	P32W2A2-50-72	72.0	(65.5)	1 Roll	9 Rolls
4X4 thru 6X4	P32W2A2-75-7	7.0	(6.4)	1 Roll	60 Rolls
	P32W2A2-75-72	72.0	(65.5)	1 Roll	7 Rolls

**Ordering Information:**  
 For Factory Applied Tape:  
 • Add -A to the Duct or Raceway Part Number  
 To Order Tape Separately:  
 • Order number of rolls required



# PANDUCT® Installation Tools



- Quickly & easily cuts duct & cover



DCT-BLD

DCT-RI

Part Number	Description	Std Pkg Qty.
-------------	-------------	--------------

### PANDUCT® Cutting Tool (For use with all duct/raceway types)

Heavy duty steel tool incorporates a new, improved blade design which minimizes cutting force and blade wear. Provides a smooth burr-free cut on both wiring duct and cover.

DCT	Hand held duct and cover cutting tool	1
-----	---------------------------------------	---

### Replacement Blade Kit (Includes Blade & Nylon Insert)

DCT-BLD	Replacement blade and nylon insert for above tool	1
---------	---	---

### Replacement Nylon Insert

DCT-RI	Replacement nylon insert for above tool	1
--------	---	---

NOTE: Always use approved safety goggles when using any tools  
ORDERING INFORMATION: Order in multiples of standard pkg. qty.



*Use to cut any PANDUCT® Duct or Cover*

Note: Cut cover as shown, latch side-up.



- Notches duct sidewalls to bottom scoreline for "T" and corner junctions

### PANDUCT® Notching Tool (For use with all duct/raceway types)

A heavy duty tool used to notch slotted wall wiring duct from the bottom of a slot to the base of the duct. Used with all sizes of slotted wall wiring duct.

DNT-100	Hand held notching tool	1
---------	-------------------------	---

ORDERING INFORMATION: Order in multiples of standard pkg. qty.



**Step 1 —**  
Notch wiring duct sidewall at the desired opening width



**Step 2 —**  
Snap off notched wiring duct piece at bottom scoreline



TNR



NR1

Total Thickness of Panel & Duct	Panel Hole Dia. Needed
.158" (4.0)–.187" (4.7)	.187" (4.7)
.188" (4.8)–.218" (5.5)	.193" (4.9)
.219" (5.6)–.250" (6.4)	.203" (5.2)
.251" (6.5) and up	.213" (5.4)

### PANDUCT® Nylon Rivet Installation Tool

An easy to use hand held tool to install PANDUIT Nylon rivets.

TNR	Hand held nylon rivet installation tool	1
-----	---	---

### PANDUCT® Nylon Rivets

NR1-C	Nylon rivet for use with TNR Rivet Tool shown above	100 pcs.
NR1-M		1000 pcs.

ORDERING INFORMATION: Order in multiples of standard pkg. qty.



**Step 1 —**  
Insert rivet into tool



**Step 2 —**  
Position rivet into hole



**Step 3 —**  
Install rivet with sharp tap

# PANDUCT® Accessories—Divider Wall

## Duct Divider Wall

### For All PVC Duct Types and Sizes (G, F, FS, D)

The wiring duct divider wall is mounted inside any PVC wiring duct in order to create multiple channels within the wiring duct. Simply use the mounting bases below when installing the duct and the divider wall will “snap” on.

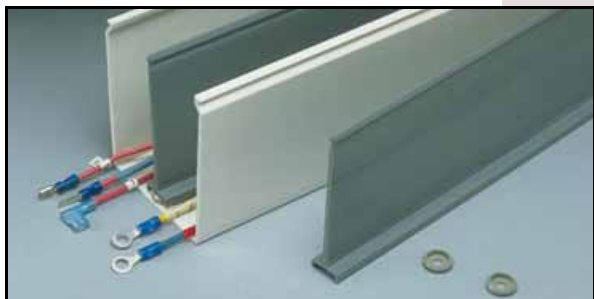

**New!**



- Both versions snap onto DB-C mounting base



- Installed when mounting duct
- Acts as a shroud around the screw to protect wires from abrasion

Part Number	For Duct Height Inches (mm)	Std. Length	Std Ctn. Qty.
-------------	-----------------------------	-------------	---------------

### PANDUCT® Divider Wall—For Type G, F, FS, D Ducts

PVC Divider Wall snaps onto mounting base below			
D1H6	1.00 (25.4)	6 ft.	120 ft.
D1.5H6	1.50 (38.1)	6 ft.	120 ft.
D2H6	2.00 (50.8)	6 ft.	120 ft.
D3H6	3.00 (76.2)	6 ft.	120 ft.
D4H6	4.00 (101.6)	6 ft.	120 ft.

### PANDUCT® Slotted Divider Wall—For Type G, F, FS, D Ducts

PVC Divider Wall snaps onto mounting base below			
SD2H6	2.00 (50.8)	6 ft.	120 ft.
SD3H6	3.00 (76.2)	6 ft.	120 ft.
SD4H6	4.00 (101.6)	6 ft.	120 ft.

ORDERING INFORMATION: Order in multiples of standard foot length

Part Number	Used with Anchors	Std Pkg. Qty.
-------------	-------------------	---------------

### PANDUCT® Divider Wall Mounting Base

Mounting Base accepts divider wall above. Recommend use of 4 mounting bases for every 6 feet of divider wall installed.

DB-C	Panduit NR1 (See <a href="#">pg. 23</a> ) or #8 or #10 screw.	100 pcs.
------	---	----------

ORDERING INFORMATION: Order number of pieces required in multiples of standard pkg. qty.

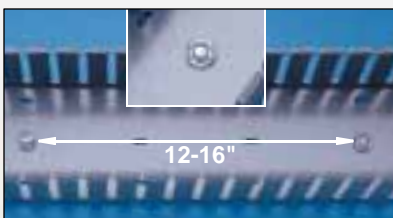

**Installing Base—**  
Install a DB-C at least every 12" - 16" as duct is installed.

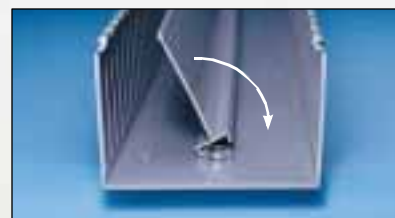

**Installing Divider Wall—**  
Snap the divider wall to the mounting bases already installed.

# PANDUCT® Accessories—Wire Retainers



## Divider Wall Wire Retainer

- “Snaps-on” directly to the divider wall
- Made of Nylon

Part Number	Material	Length Inches (mm)	Std Pkg. Qty.
-------------	----------	--------------------	---------------

### PANDUCT® Divider Wall Wire Retainer (snaps-on to divider wall)

Wire retainer for use with duct divider wall (shown on previous page).

<b>T3WR-C</b>	NYLON	1.05" (26.7)	100 pcs.
---------------	-------	--------------	----------

ORDERING INFORMATION: Order number of pieces required in multiples of standard pkg. qty.



## Wire Retainer—Type G, E

- Snaps into slots of Type G & Type E Duct
- Made of Nylon

Part Number	Material	For Duct Size		Std Pkg. Qty.
		Width	Height	

### PANDUCT® Type G Duct and Type E Duct Wire Retainer

Wire retainer for use with Type G Duct.

<b>WR2-C</b>	NYLON	2.0" (50.8)	4.0" (101.6) or Under	100 pcs.
<b>WR3-C</b>	NYLON	3.0" (76.2)	4.0" (101.6) or Under	100 pcs.
<b>WR4-C</b>	NYLON	4.0" (101.6)	4.0" (101.6) or Under	100 pcs.
<b>WR5-C</b>	NYLON	Use with: 2x5, 3x5, 4x5 or 6x4 G-Duct		100 pcs.

ORDERING INFORMATION: Order number of pieces required in multiples of standard pkg. qty.



## Wire Retainer—Type F

- Snaps into slots of Type F Duct
- One size fits four different duct widths
- Made of Rigid PVC

Part Number	Material	For Duct Width Inches (mm)	Std Pkg. Qty.
-------------	----------	----------------------------	---------------

### PANDUCT® Type F Duct Wire Retainer/Labeling Device

Wire retainer for use with Type F Duct. Can also be used as a labeling device (for labels see page 28)

<b>FWR-C</b>	RIGID PVC	1.50" (38.1)	100 pcs.
		2.00" (50.8)	
		3.00" (76.2)	
		4.00" (101.6)	

NOTE: Full length is used with 4" wide duct. For smaller widths, break off segments at scorelines.  
ORDERING INFORMATION: Order number of pieces required in multiples of standard pkg. qty.



## Wire Retainer—Type FS, D

- Mounts onto walls of Type FS Raceway or Type D Duct
- One size fits three different duct widths

Part Number	Material	For Duct Width Inches (mm)	Std Pkg. Qty.
-------------	----------	----------------------------	---------------

### PANDUCT® Type FS & D Duct Wire Retainer

Wire retainer for use with Type FS Solid Wall Raceway or Type D Round Hole Duct. Supplied with adhesive backing for fast installation.

<b>WRS-A-C10</b>	RIGID PVC	1.00" (25.4)	100 pcs.
		1.50" (38.1)	
		2.00" (50.8)	

NOTE: Full length is used with 2" wide duct. For smaller widths, break off segments at scorelines.  
ORDERING INFORMATION: Order number of pieces required in multiples of standard pkg. qty.



# PANDUCT® Accessories—Duct Corner & Joining Strips

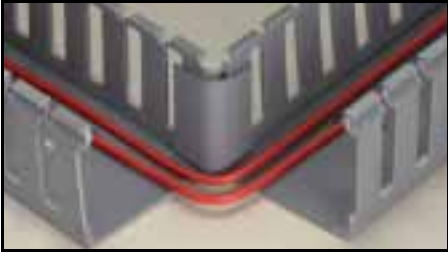

### Duct Corner Strip

- Snaps onto duct at corner or "T" junctions for smooth, round corners
- Strip is cut to length (6 foot lengths) or is available in pre-cut pieces



Part Number	Material	For Duct Height	Color	Std. Length	Std. Ctn. Qty.
-------------	----------	-----------------	-------	-------------	----------------

### PANDUCT® Duct Corner Strip—6 Foot Lengths

For All PVC Wiring Duct Types

6 foot length. Joins sections of duct together at corners or "T" junctions. Used with any PVC Wiring Duct, Type G, F and D Duct and FS Raceway. 6 foot length is cut by user to fit duct height.

CS1BL6 CS1DG6 CS1LG6 CS1WH6	RIGID PVC	Cut to Size	Black Dark Gray Light Gray White	6 ft.	120 ft.
--------------------------------------	-----------	-------------	---	-------	---------

ORDERING INFORMATION: Order number of feet required in multiples of 6ft. or Std. Carton quantities.

Part Number	Material	For Duct Height	Color	Std. Pkg. Qty
-------------	----------	-----------------	-------	---------------

### PANDUCT® Duct Corner Strip—Pre Cut Pieces

For All PVC Wiring Duct Types

Pre-cut pieces are cut to size. Joins sections of duct together at corners or "T" junctions. Used with any PVC Wiring Duct, Type G, F and D Duct and FS Raceway.

CSP1LG-Q CSP1.5LG-Q CSP2LG-Q CSP3LG-Q CSP4LG-Q	RIGID PVC	1.00" (25.4) 1.50" (38.1) 2.00" (50.8) 3.00" (76.2) 4.00" (101.6)	Light Gray only	25 pcs.
--	-----------	---	-----------------	---------

NOTE: Actual length of CSP pre-cut pieces are less than "For Duct Height" shown.  
ORDERING INFORMATION: Order number of pieces required in multiples of standard pkg. qty.

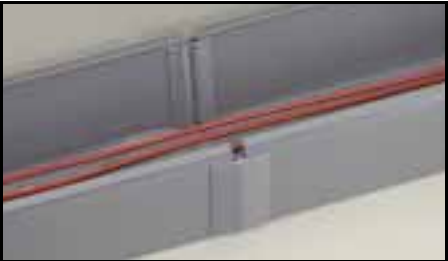

### Duct Joining Strip

- Snaps onto duct to join sections together
- Strip is cut to length (6 foot lengths) or is available in pre-cut pieces



Part Number	Material	For Duct Height	Color	Std. Length	Std. Ctn. Qty.
-------------	----------	-----------------	-------	-------------	----------------

### PANDUCT® Duct Joining Strip—6 Foot Lengths

For All PVC Wiring Duct Types

6 foot length. Joins sections of duct together. Used with any PVC Wiring Duct, Type G, F and D Duct and FS Raceway. 6 foot length is cut by user to fit duct height.

DJS1BL6 DJS1DG6 DJS1LG6 DJS1WH6	RIGID PVC	Cut to Size	Black Dark Gray Light Gray White	6 ft.	120 ft.
--	-----------	-------------	---	-------	---------

ORDERING INFORMATION: Order number of feet required in multiples of 6ft. or Std. Carton quantities.

Part Number	Material	For Duct Height	Color	Std. Pkg. Qty
-------------	----------	-----------------	-------	---------------

### PANDUCT® Duct Joining Strip—Pre Cut Pieces

For All PVC Wiring Duct Types

Pre-cut pieces are cut to size. Joins sections of duct together. Used with any PVC Wiring Duct, Type G, F and D Duct and FS Raceway.

DJSP1LG-Q DJSP1.5LG-Q DJSP2LG-Q DJSP3LG-Q DJSP4LG-Q	RIGID PVC	1.00" (25.4) 1.50" (38.1) 2.00" (50.8) 3.00" (76.2) 4.00" (101.6)	Light Gray only	25 pcs.
---	-----------	---	-----------------	---------

NOTE: Actual length of DJSP pre-cut pieces are less than "For Duct Height" shown.  
ORDERING INFORMATION: Order number of pieces required in multiples of standard pkg. qty.

# PANDUCT® Accessories—Mounting Brackets & Fasteners



## Snap Clip—Types G, F, & FS

- Duct easily snaps into bracket
- No mounting holes required in duct
- Ensures no metal is inside the duct
- Snap-clip spacing is not critical
- Simplifies fabrication drawings and panel layout

Part Number	Screw Provided	Part Number	Screw Required	For Duct Width Inches (mm)	Std. Pkg. Qty.
-------------	----------------	-------------	----------------	----------------------------	----------------

## PANDUCT® Snap-Clip Mounting Bracket—Type G, F & FS Duct

With Mounting Screw		Without Mounting Screw		For Duct Width Inches (mm)	Std. Pkg. Qty.
S1F-C S1.5F-C S2F-C S3F-C S4F-C	#8-32x1/4 (Provided)	SNS1F-C SNS1.5F-C SNS2F-C SNS3F-C SNS4F-C	#8-32x1/4 (User Supplied)		

Snap-clip provided with or without self tapping screw. Made from nickel plated spring steel.

ORDERING INFORMATION: Order number of pieces required in multiples of standard pkg. qty.

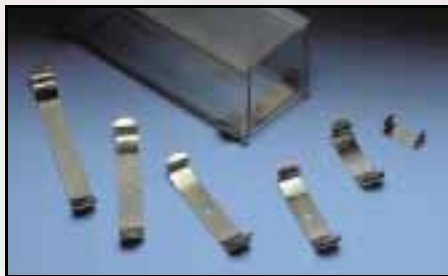

## Snap Clip—Types NE, NS, PE, PS, D, E & S

- Duct easily snaps into bracket
- No mounting holes required in duct
- Ensures no metal is inside the duct
- Snap-clip spacing is not critical
- Simplifies fabrication drawings and panel layout

Part Number	Screw Provided	Part Number	Screw Required	For Duct Width Inches (mm)	Std. Pkg. Qty.
-------------	----------------	-------------	----------------	----------------------------	----------------

## PANDUCT® Snap-Clip Mounting Bracket—Type NE, NS, PE, PS, D, E & S Duct

With Mounting Screw		Without Mounting Screw		For Duct Width Inches (mm)	Std. Pkg. Qty.
S.5-C S.75-C	#6-32x1/4 (Provided)	SNS.5-C SNS.75-C	#6-32x1/4 (User Supplied)		
S1-C S1.5-C S2-C S2.5-C S3-C S4-C	#8-32x1/4 (Provided)	SNS1-C SNS1.5-C SNS2-C SNS2.5-C SNS3-C SNS4-C	#8-32x1/4 (User Supplied)	1.00" (25.4) 1.50" (38.1) 2.00" (50.8) 2.50" (63.5) 3.00" (76.2) 4.00" (101.6)	100 pcs.

Snap-clip provided with or without self tapping screw. Made from nickel plated spring steel.

ORDERING INFORMATION: Order number of pieces required in multiples of standard pkg. qty.



## Stud Type Fasteners

- Secures cover in place during shipping or extreme vibration
- Provides tamper resistance
- Fits into the standard mounting holes available on duct.†

Part Number	Description	Thread Size	For Duct Width Inches (mm)	Std. Pkg. Qty.
-------------	-------------	-------------	----------------------------	----------------

## PANDUCT® Stud Type Fasteners—For all Duct/Raceway Types

F1-C F1.5-C F2-C F3-C F4-C	Corrosion resistant zinc plated steel stud with fastener. Secures cover in place. Also used to mount a smaller size duct within a larger duct.	10/24 threads on each end	1.00" (25.4) 1.50" (38.1) 2.00" (50.8) 3.00" (76.2) 4.00" (101.6)	100 pcs.
--	--	---------------------------	---	----------

†A .200" (5mm) hole must be drilled in the cover to accommodate the fastener

ORDERING INFORMATION: Order number of pieces required in multiples of standard pkg. qty.



- Can be used to mount a smaller size duct within larger duct to create a completely separate channel

# PANDUCT® Accessories—Labeling

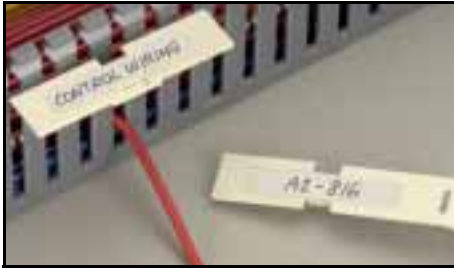

## Wire Retainer/Labeling Device—Type F

- Used to identify both wires exiting duct and adjacent terminations
- Use with write-on, computer printable labels, or write directly on the labeling device
- Made of rigid PVC
- For use with F Duct Only

Part Number	Material	Length Inches (mm)	Std Pkg. Qty.
-------------	----------	--------------------	---------------

### PANDUCT® Type F Duct Wire Retainer/Labeling Device

Wire retainer for use with Type F Duct. Also used as a labeling device.			
FWR-C	RIGID PVC	1.50" (38.1)	100 pcs.
		2.00" (50.8)	
		3.00" (76.2)	
		4.00" (101.6)	

ORDERING INFORMATION: Order number of pieces required in multiples of standard pkg. qty.



**Labeling Inside Duct—**  
Install label (shown below) on Wire Retainer. Install label & mount between fingers facing inward.



**Labeling Outside Duct—**  
Break off the last segment from wire retainer (below 1.5 mark) and snap onto the back of the remaining segment. Install label & mount between fingers facing outward.



PX-0  
PX-2



- Fast drying permanent ink

Part Number	Color	Description	Std Pkg. Qty.	Std Ctn. Qty.
-------------	-------	-------------	---------------	---------------

### Marking Pens—For use with FWR-C Labeling Device

PX-0	Black	Regular tip pen	12 pcs.	48 pcs.
PX-2	Red		12 pcs.	48 pcs.
PFX-0	Black	Fine tip pen	12 pcs.	48 pcs.
PFX-2	Red		12 pcs.	48 pcs.

ORDERING INFORMATION: Order number of pieces required in multiples of standard pkg. qty.



## Labels for FWR-C Labeling Device

- Write-on labels attach to the recessed area on FWR-C labeling device
- Computer printable or hand writable
- Individually die cut

Part Number	Description	Label Size WxH	Labels Per Row	Rows Per Fanfold	Sheet Width	Std Pkg. Qty.
-------------	-------------	----------------	----------------	------------------	-------------	---------------

### Identification Labels—For use with FWR-C Labeling Device

PDL-110-1	■TEDLAR Adhesive backed	2.00" x .38"	3	24	7.20"	1000 labels
PDL-111-1	MYLAR Adhesive backed	2.00" x .38"	3	24	7.20"	1000 labels
PDL-PB1	Non-smudge paper with overlaminates	2.00" x .38"	3	24	7.20"	1000 labels

ORDERING INFORMATION: Order number of pieces required in multiples of standard pkg. qty.

■TEDLAR is a registered trademark of E.I. Dupont Co.

NOTE: For more information on computer printable labels and software contact factory to request catalog SA101N315A-ID



# PANDUCT® Type G Wiring Duct—Dimensions

## Type G Plastic Wiring Duct Dimensions

Dimensions are shown for reference only. Consult factory for specific dimensional needs.

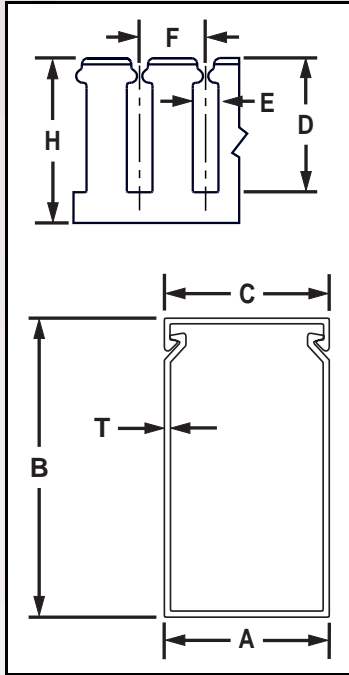

Note: "A" dimension is measured at base  
 Note: "K" dimension shown in mounting hole dimensions below

### Mounting Hole Dimensions:

For .5", .75", 1.0" and 1.5" width duct:

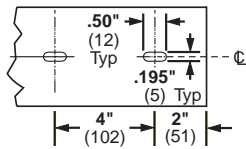

For 2.0", 2.5", 3.0", 4.0" and 6.0" width duct:

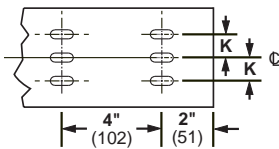

NOTE: For Type G Duct, if no mounting holes are required, add NM to the Part Number

DUCT SIZE (W x H)	DIMENSIONS-Inches (mm)									
	A	B	C	D	E	F	H	K	T	
.5 x .5 (12.7) (12.7)	0.69 (17.5)	0.56 (14.2)	0.69 (17.5)	0.38 (9.5)	0.20 (5.0)	0.50 (12.7)	0.50 (12.7)	ON CENTERLINE	0.05 (1.3)	
.5 x 1 (12.7) (25.4)	0.69 (17.5)	1.09 (27.1)	0.69 (17.5)	0.75 (19.1)	0.20 (5.0)	0.50 (12.7)	1.00 (25.4)		0.05 (1.3)	
.75 x .75 (19.1) (19.1)	0.94 (23.9)	0.83 (21.0)	0.94 (23.9)	0.58 (14.8)	0.31 (7.9)	0.80 (20.3)	0.75 (19.1)		0.06 (1.4)	
.75 x 1 (19.1) (25.4)	0.94 (23.9)	1.09 (27.6)	0.94 (23.9)	0.75 (19.1)	0.31 (7.9)	0.80 (20.3)	1.00 (25.4)		0.06 (1.4)	
.75 x 1.5 (19.1) (38.1)	0.94 (23.9)	1.58 (40.0)	0.94 (23.9)	1.20 (30.5)	0.31 (7.9)	0.80 (20.3)	1.50 (38.1)		0.07 (1.8)	
.75 x 2 (19.1) (50.8)	0.94 (23.9)	2.09 (53.0)	0.94 (23.9)	1.63 (41.3)	0.31 (7.9)	0.80 (20.3)	2.00 (50.8)		0.08 (2.0)	
1 x 1 (25.4) (25.4)	1.25 (31.8)	1.09 (27.6)	1.25 (31.8)	0.75 (19.1)	0.31 (7.9)	0.80 (20.3)	1.00 (25.4)		0.06 (1.4)	
1 x 1.5 (25.4) (38.1)	1.25 (31.8)	1.59 (40.3)	1.25 (31.8)	1.20 (30.5)	0.31 (7.9)	0.80 (20.3)	1.50 (38.1)		0.07 (1.8)	
1 x 2 (25.4) (38.1)	1.25 (31.8)	2.09 (53.0)	1.25 (31.8)	1.63 (41.3)	0.31 (7.9)	0.80 (20.3)	2.00 (50.8)		0.08 (2.0)	
1 x 3 (25.4) (76.2)	1.25 (31.8)	3.10 (78.6)	1.25 (31.8)	2.63 (66.7)	0.31 (7.9)	1.00 (25.4)	3.00 (76.2)		0.10 (2.4)	
1 x 4 (25.4) (101.5)	1.25 (31.8)	4.10 (104.0)	1.25 (31.8)	3.63 (92.1)	0.31 (7.9)	1.00 (25.4)	4.00 (101.6)		0.11 (2.7)	
1.5 x 1 (38.1) (25.4)	1.75 (44.5)	1.09 (27.6)	1.75 (44.5)	7.50 (190.5)	0.31 (7.9)	0.80 (20.3)	1.00 (25.4)		0.06 (1.5)	
1.5 x 1.5 (38.1) (38.1)	1.75 (44.5)	1.59 (40.3)	1.75 (44.5)	1.20 (30.5)	0.31 (7.9)	0.80 (20.3)	1.50 (38.1)		0.07 (1.8)	
1.5 x 2 (38.1) (50.8)	1.75 (44.5)	2.09 (53.0)	1.75 (44.5)	1.63 (41.3)	0.31 (7.9)	0.80 (20.3)	2.00 (50.8)		0.08 (2.0)	
1.5 x 3 (38.1) (76.2)	1.75 (44.5)	3.10 (78.6)	1.75 (44.5)	2.63 (66.7)	0.31 (7.9)	1.00 (25.4)	3.00 (76.2)		0.10 (2.4)	
1.5 x 4 (38.1) (101.6)	1.75 (44.5)	4.10 (104.0)	1.75 (44.5)	3.63 (92.1)	0.31 (7.9)	1.00 (25.4)	4.00 (101.6)		0.11 (2.7)	
2 x 1 (50.8) (25.4)	2.25 (57.2)	1.09 (27.6)	2.25 (57.2)	0.75 (19.1)	0.31 (7.9)	0.80 (20.3)	1.00 (25.4)		0.50 (12.7)	0.06 (1.5)
2x1.5 (50.8) (38.1)	2.25 (57.2)	1.59 (40.3)	2.25 (57.2)	1.20 (30.5)	0.31 (7.9)	0.80 (20.3)	1.50 (38.1)		0.50 (12.7)	0.70 (17.8)
2x2 (50.8) (50.8)	2.25 (57.2)	2.09 (53.0)	2.25 (57.2)	1.63 (41.3)	0.31 (7.9)	0.80 (20.3)	2.00 (50.8)		0.50 (12.7)	0.08 (2.0)
2x3 (50.8) (76.2)	2.25 (57.2)	3.10 (78.6)	2.25 (57.2)	2.63 (66.7)	0.31 (7.9)	1.00 (25.4)	3.00 (76.2)		0.50 (12.7)	0.10 (2.4)
2x4 (50.8) (101.6)	2.25 (57.2)	4.10 (104.0)	2.25 (57.2)	3.63 (92.1)	0.31 (7.9)	1.00 (25.4)	4.00 (101.6)		0.50 (12.7)	0.11 (2.7)
2x5 (50.8) (127.0)	2.25 (57.2)	5.11 (129.7)	2.25 (57.2)	4.63 (117.5)	0.38 (9.5)	1.33 (33.9)	5.00 (127.0)		0.50 (12.7)	0.12 (2.9)
2.5 x 3 (63.5) (76.2)	2.75 (69.9)	3.10 (78.7)	2.75 (69.9)	2.63 (66.7)	0.31 (7.9)	1.00 (25.4)	3.00 (76.2)		0.75 (19.1)	0.10 (2.5)
3x1 (76.2) (25.4)	3.25 (82.6)	1.09 (27.6)	3.25 (82.6)	0.75 (19.1)	0.31 (7.9)	0.80 (20.3)	1.00 (25.4)		0.50 (12.7)	0.08 (1.9)
3x2 (76.2) (50.8)	3.25 (82.6)	2.09 (53.1)	3.25 (82.6)	1.63 (41.3)	0.31 (7.9)	0.80 (20.3)	2.00 (50.8)	1.00 (25.4)	0.08 (2.0)	
3x3 (76.2) (76.2)	3.25 (82.6)	3.10 (78.7)	3.25 (82.6)	2.63 (66.7)	0.31 (7.9)	1.00 (25.4)	3.00 (76.2)	1.00 (25.4)	0.10 (2.4)	
3x4 (76.2) (101.6)	3.25 (82.6)	4.10 (104.1)	3.25 (82.6)	3.63 (92.1)	0.31 (7.9)	1.00 (25.4)	4.00 (101.6)	1.00 (25.4)	0.11 (2.7)	
3x5 (76.2) (127.0)	3.25 (82.6)	5.11 (129.8)	3.25 (82.6)	4.63 (117.5)	0.38 (9.5)	1.33 (33.9)	5.00 (127.0)	1.00 (25.4)	0.12 (2.9)	
4 x 1.5 (101.6) (38.1)	4.25 (108.0)	1.59 (40.3)	4.25 (108.0)	1.20 (30.5)	0.31 (7.9)	0.80 (20.3)	1.50 (38.1)	1.50 (38.1)	0.07 (1.8)	
4x2 (101.6) (50.8)	4.25 (108.0)	2.08 (52.8)	4.25 (108.0)	1.63 (41.3)	0.31 (7.9)	0.80 (20.3)	2.00 (50.8)	1.50 (38.1)	0.08 (2.0)	
4x3 (101.6) (76.2)	4.25 (108.0)	3.10 (78.7)	4.25 (108.0)	2.63 (66.7)	0.31 (7.9)	1.00 (25.4)	3.00 (76.2)	1.50 (38.1)	0.10 (2.5)	
4x4 (101.6) (101.6)	4.25 (108.0)	4.10 (104.1)	4.25 (108.0)	3.63 (92.1)	0.31 (7.9)	1.00 (25.4)	4.00 (101.6)	1.50 (38.1)	0.11 (2.7)	
4x5 (101.6) (127.0)	4.25 (108.0)	5.11 (129.8)	4.25 (108.0)	4.63 (117.5)	0.38 (9.5)	1.33 (33.9)	5.00 (127.0)	1.50 (38.1)	0.12 (2.9)	
6x4 (152.4) (101.6)	6.25 (158.8)	4.11 (104.4)	6.25 (158.8)	3.63 (92.1)	0.31 (7.9)	1.00 (25.4)	4.00 (101.6)	2.50 (63.5)	0.11 (2.8)	

(see pg. 36 for color and size chart)

# PANDUCT® Type F & FS Wiring Duct—Dimensions

## Type F & FS Plastic Wiring Duct Dimensions

Dimensions are shown for reference only. Consult factory for specific dimensional needs.

For .5", .75", 1.0" and 1.5" duct height:

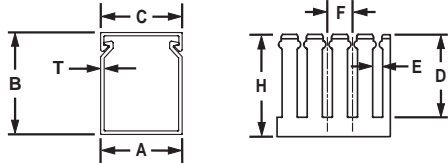

For 2", 3", 4" and 5" duct height:

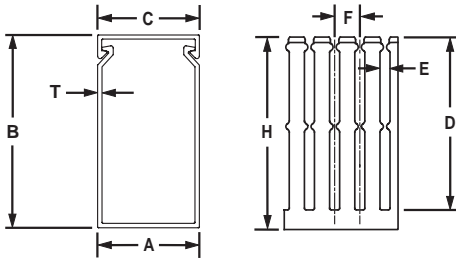

Note: "A" dimension is measured at base  
Note: "K" dimension shown in mounting hole dimensions below

### Mounting Hole Dimensions:

For .5", .75", 1.0" and 1.5" width duct:

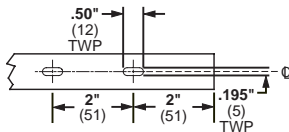

For 2.0", 2.5", 3.0", 4.0" and 6.0" width duct:

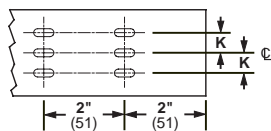

NOTE: For Type F Duct, if no mounting holes are required, add NM to the Part Number  
NOTE 2: For Type FS Duct, no mounting holes are provided; if required delete NM from the Part Number

DUCT SIZE (W x H)	DIMENSIONS-Inches (mm)							
	A	B	C	D	E	F	H	T
.5 x .5 (12.7) (12.7)	0.69 (17.5)	0.56 (14.2)	0.69 (17.5)	0.38 (9.5)	0.20 (5.0)	0.50 (12.7)	0.50 (12.7)	0.05 (1.3)
.5 x 1 (12.7) (25.4)	0.69 (17.5)	1.09 (27.6)	0.69 (17.5)	0.75 (19.1)	0.20 (5.0)	0.50 (12.7)	1.00 (25.4)	0.05 (1.3)
.75 x .75 (19.1) (19.1)	0.94 (23.9)	0.83 (21.0)	0.94 (23.9)	0.58 (14.8)	0.20 (5.0)	0.50 (12.7)	0.75 (19.1)	0.06 (1.4)
.75 x 1 (19.1) (25.4)	0.94 (23.9)	1.09 (27.6)	0.94 (23.9)	N/A	N/A	N/A	1.00 (25.4)	0.07 (1.4)
.75 x 1.5 (19.1) (38.1)	0.94 (23.9)	1.58 (40.0)	0.94 (23.9)	1.20 (30.5)	0.20 (5.0)	0.50 (12.7)	1.50 (38.1)	0.07 (1.8)
.75 x 2 (19.1) (50.8)	0.94 (23.9)	2.09 (53.0)	0.94 (23.9)	N/A	N/A	N/A	2.00 (50.8)	0.08 (2.0)
1 x 1 (19.1) (25.4)	1.25 (31.8)	1.09 (27.6)	1.25 (31.8)	0.75 (19.1)	0.20 (5.0)	0.50 (12.7)	1.00 (25.4)	0.06 (1.4)
1 x 1.5 (25.4) (38.1)	1.25 (31.8)	1.59 (40.3)	1.25 (31.8)	1.20 (30.5)	0.20 (5.0)	0.50 (12.7)	1.50 (38.1)	0.07 (1.8)
1 x 2 (25.4) (38.1)	1.25 (31.8)	2.09 (53.0)	1.25 (31.8)	1.63 (41.3)	0.20 (5.0)	0.50 (12.7)	2.00 (50.8)	0.08 (2.0)
1 x 3 (25.4) (76.2)	1.25 (31.8)	3.10 (78.6)	1.25 (31.8)	2.63 (66.7)	0.20 (5.0)	0.50 (12.7)	3.00 (76.2)	0.10 (2.4)
1.5 x 1 (38.1) (25.4)	1.75 (44.5)	1.09 (27.6)	1.75 (44.5)	0.75 (19.1)	0.20 (5.0)	0.50 (12.7)	1.00 (25.4)	0.06 (1.5)
1.5 x 1.5 (38.1) (38.1)	1.75 (44.5)	1.59 (40.3)	1.75 (44.5)	1.20 (30.5)	0.20 (5.0)	0.50 (12.7)	1.50 (38.1)	0.07 (1.8)
1.5 x 2 (38.1) (50.8)	1.75 (44.5)	2.09 (53.0)	1.75 (44.5)	1.63 (41.3)	0.20 (5.0)	0.50 (12.7)	2.00 (50.8)	0.08 (2.0)
1.5 x 3 (38.1) (76.2)	1.75 (44.5)	3.10 (78.6)	1.75 (44.5)	2.63 (66.7)	0.20 (5.0)	0.50 (12.7)	3.00 (76.2)	0.10 (2.4)
2 x 1 (50.8) (25.4)	2.25 (57.2)	1.09 (27.6)	2.25 (57.2)	0.75 (19.1)	0.20 (5.0)	0.50 (12.7)	1.00 (25.4)	0.06 (1.5)
2 x 1.5 (50.8) (38.1)	2.25 (57.2)	1.59 (40.3)	2.25 (57.2)	1.20 (30.5)	0.20 (5.0)	0.50 (12.7)	1.50 (38.1)	0.07 (1.8)
2 x 2 (50.8) (50.8)	2.25 (57.2)	2.09 (53.0)	2.25 (57.2)	1.63 (41.3)	0.20 (5.0)	0.50 (12.7)	2.00 (50.8)	0.08 (2.0)
2 x 3 (50.8) (76.2)	2.25 (57.2)	3.10 (78.6)	2.25 (57.2)	2.63 (66.7)	0.20 (5.0)	0.50 (12.7)	3.00 (76.2)	0.10 (2.4)
2 x 4 (50.8) (101.6)	2.25 (57.2)	4.10 (104.0)	2.25 (57.2)	3.63 (92.1)	0.20 (5.0)	0.50 (12.7)	4.00 (101.6)	0.11 (2.7)
2 x 5 (50.8) (127.0)	2.25 (57.2)	5.11 (129.7)	2.25 (57.2)	4.63 (117.5)	0.20 (5.0)	0.50 (12.7)	5.00 (127.0)	0.12 (2.9)
2.5 x 3 (63.5) (76.2)	2.75 (69.9)	3.10 (78.7)	2.75 (69.9)	N/A	N/A	N/A	3.00 (76.2)	0.10 (2.4)
3 x 1 (76.2) (25.4)	3.25 (82.6)	1.09 (27.7)	3.25 (82.6)	0.75 (19.1)	0.20 (5.0)	0.50 (12.7)	1.00 (25.4)	0.08 (2.0)
3 x 2 (76.2) (50.8)	3.25 (82.6)	2.09 (53.1)	3.25 (82.6)	1.63 (41.3)	0.20 (5.0)	0.50 (12.7)	2.00 (50.8)	0.08 (2.0)
3 x 3 (76.2) (76.2)	3.25 (82.6)	3.10 (78.7)	3.25 (82.6)	2.63 (66.7)	0.20 (5.0)	0.50 (12.7)	3.00 (76.2)	0.10 (2.4)
4 x 1.5 (101.6) (38.1)	4.25 (108.0)	1.59 (40.3)	4.25 (108.0)	N/A	N/A	N/A	1.50 (38.1)	0.08 (2.0)
4 x 2 (101.6) (50.8)	4.25 (108.0)	2.08 (52.8)	4.25 (108.0)	1.63 (41.3)	0.20 (5.0)	0.50 (12.7)	2.00 (50.8)	0.08 (2.0)
4 x 3 (101.6) (76.2)	4.25 (108.0)	3.10 (78.7)	4.25 (108.0)	2.63 (66.7)	0.20 (5.0)	0.50 (12.7)	3.00 (76.2)	0.10 (2.5)
4 x 4 (101.6) (101.6)	4.25 (108.0)	4.10 (104.1)	4.25 (108.0)	3.63 (92.1)	0.20 (5.0)	0.50 (12.7)	4.00 (101.6)	0.11 (2.7)
4 x 5 (101.6) (127.0)	4.25 (108.0)	5.11 (129.8)	4.25 (108.0)	4.63 (117.5)	0.20 (5.0)	0.50 (12.7)	5.00 (127.0)	0.12 (2.9)
6 x 4 (152.4) (101.6)	6.25 (158.8)	4.11 (104.4)	6.25 (158.8)	N/A	N/A	N/A	4.00 (101.6)	0.11 (2.8)

>Available for Type FS Duct only (see pg. 36 for color and size chart).

# PANDUCT® Type NE, NS, PE, PS, D, E & S—Dimensions

## Type NE, NS, PE, PS, E, S and D Plastic Wiring Duct Dimensions

Dimensions are shown for reference only. Consult factory for specific dimensional needs.

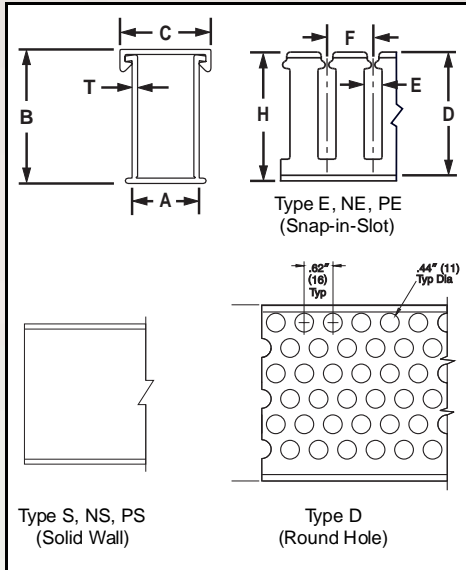

Note: "A" dimension is measured at base  
 Note: "K" dimension shown in mounting hole dimensions below

### Mounting Hole Dimensions:

For .5", .75", 1.0" and 1.5" width duct:

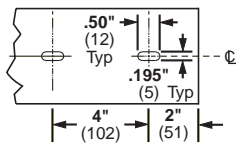

For 2.0", 2.5", 3.0", 4.0" and 6.0" width duct:

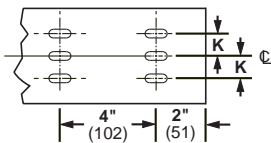

NOTE: For Types E, NE, PE & D Duct, if no mounting holes are required, add NM to the Part Number

NOTE 2: For Types S, NS & PS Duct, no mounting holes are provided; if required delete NM from the Part Number

DUCT SIZE (W x H)	DIMENSIONS-Inches (mm)							Cover
	A	B	D	E	F	K	T	
.5 x .5	0.63 (16.0)	0.56 (14.2)	0.38 (9.7)	0.37 (9.4)	0.80 (20.3)		0.05 (1.3)	0.69 (17.5)
.5 x .62	0.63 (16.0)	0.68 (17.3)	0.38 (9.7)	0.37 (9.4)	0.80 (20.3)		0.05 (1.3)	0.69 (17.5)
.5 x 1	0.63 (16.0)	1.06 (26.9)	0.75 (19.1)	0.31 (7.9)	0.80 (20.3)		0.06 (1.5)	0.69 (17.5)
.5 x 1.25	0.63 (16.0)	1.31 (33.3)	1.00 (25.4)	0.31 (7.9)	0.80 (20.3)		0.06 (1.5)	0.69 (17.5)
.5 x 1.75	0.63 (16.0)	1.81 (46.0)	1.44 (36.6)	0.31 (7.9)	0.80 (20.3)		0.07 (1.8)	0.69 (17.5)
.5 x 2	0.63 (16.0)	2.06 (52.3)	1.63 (41.4)	0.31 (7.9)	0.80 (20.3)		0.08 (1.9)	0.69 (17.5)
.75 x .75	0.88 (22.4)	0.81 (20.6)	0.56 (14.2)	0.31 (7.9)	0.80 (20.3)		0.06 (1.4)	1.00 (25.4)
.75 x 1	0.88 (22.4)	1.06 (26.9)	0.75 (19.1)	0.31 (7.9)	0.80 (20.3)		0.06 (1.5)	1.00 (25.4)
.75 x 1.5	0.88 (22.4)	1.56 (39.6)	1.20 (30.5)	0.31 (7.9)	0.80 (20.3)		0.07 (1.8)	1.00 (25.4)
.75 x 2	0.88 (22.4)	2.12 (53.8)	1.63 (41.4)	0.31 (7.9)	0.80 (20.3)		0.08 (1.9)	1.00 (25.4)
1 x 1	1.14 (29.0)	1.12 (28.4)	0.75 (19.1)	0.31 (7.9)	0.80 (20.3)		0.06 (1.5)	1.25 (31.8)
1 x 1.25	1.14 (29.0)	1.37 (34.8)	1.00 (25.4)	0.31 (7.9)	0.80 (20.3)		0.07 (1.7)	1.25 (31.8)
1 x 1.5	1.14 (29.0)	1.62 (41.1)	1.20 (30.5)	0.31 (7.9)	0.80 (20.3)		0.07 (1.8)	1.25 (31.8)
1 x 2	1.14 (29.0)	2.12 (53.8)	1.63 (41.4)	0.31 (7.9)	0.80 (20.3)		0.08 (2.0)	1.25 (31.8)
1 x 2.5	1.14 (29.0)	2.62 (66.5)	2.13 (54.1)	0.31 (7.9)	0.80 (20.3)		0.09 (2.2)	1.25 (31.8)
1 x 3	1.14 (29.0)	3.12 (79.2)	2.63 (66.8)	0.31 (7.9)	1.00 (25.4)		0.10 (2.4)	1.25 (31.8)
1 x 4	1.14 (29.0)	4.12 (104.6)	3.63 (92.2)	0.31 (7.9)	1.00 (25.4)		0.11 (2.7)	1.25 (31.8)
1.5 x 1	1.64 (41.7)	1.12 (28.4)	0.75 (19.1)	0.31 (7.9)	0.80 (20.3)		0.06 (1.5)	1.75 (44.5)
1.5 x 1.5	1.64 (41.7)	1.62 (41.1)	1.20 (30.5)	0.31 (7.9)	0.80 (20.3)		0.07 (1.8)	1.75 (44.5)
1.5 x 2	1.64 (41.7)	2.12 (53.8)	1.63 (41.4)	0.31 (7.9)	0.80 (20.3)		0.08 (2.0)	1.75 (44.5)
1.5 x 3	1.64 (41.7)	3.12 (79.2)	2.63 (66.8)	0.31 (7.9)	1.00 (25.4)		0.10 (2.4)	1.75 (44.5)
1.5 x 4	1.64 (41.7)	4.12 (104.6)	3.63 (92.2)	0.31 (7.9)	1.00 (25.4)		0.11 (2.7)	1.75 (44.5)
2 x 1	2.14 (54.4)	1.12 (28.4)	0.75 (19.1)	0.31 (7.9)	0.80 (20.3)	0.50 (12.7)	0.06 (1.5)	2.25 (57.2)
2x1.5	2.14 (54.4)	1.62 (41.1)	1.20 (30.5)	0.31 (7.9)	0.80 (20.3)	0.50 (12.7)	0.06 (1.5)	2.25 (57.2)
2x2	2.14 (54.4)	2.12 (53.8)	1.63 (41.4)	0.31 (7.9)	0.80 (20.3)	0.50 (12.7)	0.08 (2.0)	2.25 (57.2)
2 x 2.5	2.14 (54.4)	2.62 (66.5)	2.13 (54.1)	0.31 (7.9)	0.80 (20.3)	0.50 (12.7)	0.09 (2.2)	2.25 (57.2)
2 x 3	2.14 (54.4)	3.12 (79.2)	2.63 (66.8)	0.31 (7.9)	1.00 (25.4)	0.50 (12.7)	0.10 (2.4)	2.25 (57.2)
2x4	2.14 (54.4)	4.12 (104.6)	3.63 (92.2)	0.31 (7.9)	1.00 (25.4)	0.50 (12.7)	0.11 (2.7)	2.25 (57.2)
2 x 5	2.14 (54.4)	5.12 (130.0)	4.12 (104.6)	0.37 (9.4)	1.50 (38.1)	0.50 (12.7)	0.13 (3.2)	2.25 (57.2)
2.5 x 3	2.64 (67.1)	3.12 (79.2)	2.63 (66.8)	0.31 (7.9)	1.00 (25.4)	0.75 (19.1)	0.10 (2.4)	2.75 (69.9)
3 x 1	3.14 (79.8)	1.12 (28.4)	.75 (19.1)	.31 (7.9)	0.80 (20.3)	1.00 (25.4)	0.60 (15.2)	3.25 (82.6)
3 x 1.25	3.14 (79.8)	1.37 (34.8)	1.00 (25.4)	0.31 (7.9)	0.80 (20.3)	1.00 (25.4)	0.07 (1.7)	3.25 (82.6)
3x2	3.14 (79.8)	2.12 (53.8)	1.63 (41.4)	0.31 (7.9)	0.80 (20.3)	1.00 (25.4)	0.08 (2.0)	3.25 (82.6)
3x3	3.14 (79.8)	3.12 (79.2)	2.63 (66.8)	0.31 (7.9)	1.00 (25.4)	1.00 (25.4)	0.10 (2.4)	3.25 (82.6)
3x4	3.14 (79.8)	4.12 (104.6)	3.63 (92.2)	0.31 (7.9)	1.00 (25.4)	1.00 (25.4)	0.11 (2.7)	3.25 (82.6)
3x5	3.14 (79.8)	5.12 (130.0)	4.63 (117.6)	0.37 (9.4)	1.34 (34.0)	1.00 (25.4)	0.12 (2.9)	3.25 (82.6)
4 x 1.5	4.14 (105.2)	1.62 (41.1)	1.20 (30.5)	0.31 (7.9)	0.80 (20.3)	1.50 (38.1)	0.07 (1.8)	4.25 (108.0)
4x2	4.14 (105.2)	2.12 (53.8)	1.63 (41.4)	0.31 (7.9)	0.80 (20.3)	1.50 (38.1)	0.08 (2.0)	4.25 (108.0)
4x3	4.14 (105.2)	3.12 (79.2)	2.63 (66.8)	0.31 (7.9)	1.00 (25.4)	1.50 (38.1)	0.10 (2.4)	4.25 (108.0)
4x4	4.14 (105.2)	4.12 (104.6)	3.63 (92.2)	0.31 (7.9)	1.00 (25.4)	1.50 (38.1)	0.11 (2.7)	4.25 (108.0)
4x5	4.14 (105.2)	5.12 (130.0)	4.63 (117.6)	0.37 (9.4)	1.50 (38.1)	1.50 (38.1)	0.12 (2.9)	4.25 (108.0)

Not all sizes available for each duct type (see pg. 36 for color and size chart)



# PANDUCT® Type G, F & FS Wiring Duct—Wirefill Capacity

NOMINAL DUCT SIZE (W X H)	AREA in <sup>2</sup>	ELECTRICAL											CAT 5 CABLES							
		8 AWG		10 AWG		12 AWG		14 AWG			16 AWG		18 AWG		22 AWG			24 AWG		
		.216	.153	.122	.158	.105	.139	.165	.096	.125	.084	.113	.065	.217	.250	.422				
	THHN	THHN	THHN	MTW	THHN	MTW	MTW	TFFN	MTW	TFFN	MTW	MTW	UTP/ CM CAT 5	STP/ CM CAT 5	UTP/CM					
.5x.5	0.250	3	6	10	6	13	7	5	16	9	20	11	34	3	2	1				
.5x1	0.500	6	12	19	11	26	15	10	31	18	40	22	68	6	5	2				
.75x.75	0.563	7	14	22	13	29	17	12	35	21	46	25	76	7	5	2				
.75x1	0.750	9	18	29	17	39	22	16	47	27	61	34	101	9	7	2				
.75x1.5	1.125	14	27	43	26	58	33	24	70	41	91	50	152	14	10	4				
.75x2	1.500	18	37	58	34	78	44	31	93	55	121	67	203	18	14	5				
1x1	1.000	12	24	38	23	52	30	21	62	37	81	45	135	12	9	3				
1x1.5	1.500	18	37	58	34	78	44	31	93	55	121	67	203	18	14	5				
1x2	2.000	24	49	77	46	104	59	42	124	73	162	90	270	24	18	6				
1x3	3.000	37	73	115	69	155	89	63	186	110	243	134	406	36	27	10				
1x4	4.000	49	98	154	92	207	118	84	248	146	324	179	541	49	37	13				
1.5x1	1.500	18	37	58	34	78	44	31	93	55	121	67	203	18	14	5				
1.5x1.5	2.250	28	55	86	52	117	67	47	140	82	182	101	304	27	21	7				
1.5x2	3.000	37	73	115	69	155	89	63	186	110	243	134	406	36	27	10				
1.5x3	4.500	55	110	173	103	233	133	94	279	165	364	201	609	55	41	14				
1.5x4	6.000	73	146	230	137	311	177	126	372	219	486	269	811	73	55	19				
2x1	2.000	24	49	77	46	104	59	42	124	73	162	90	270	24	18	6				
2x1.5	3.000	37	73	115	69	155	89	63	186	110	243	134	406	36	27	10				
2x2	4.000	49	98	154	92	207	118	84	248	146	324	179	541	49	37	13				
2x3	6.000	73	146	230	137	311	177	126	372	219	486	269	811	73	55	19				
2x4	8.000	98	195	307	183	415	237	168	496	293	648	358	1062	97	73	26				
2x5	10.000	122	244	384	229	518	296	210	620	366	810	448	1352	121	91	32				
2.5x3	7.500	92	183	288	172	389	222	157	465	274	607	336	1014	91	69	24				
3x1	3.000	37	73	115	69	155	89	63	186	110	243	134	406	36	27	10				
3x2	6.000	73	146	230	137	311	177	126	372	219	486	269	811	73	55	19				
3x3	9.000	110	220	346	206	466	266	189	558	329	729	403	1217	109	82	29				
3x4	12.000	147	293	461	275	622	355	252	744	439	972	537	1623	146	110	39				
3x5	15.000	184	366	576	343	777	444	315	930	549	1215	671	2029	182	137	48				
4x1.5	6.000	73	146	230	137	311	177	126	372	319	486	269	811	73	55	19				
4x2	8.000	98	195	307	183	415	237	268	496	293	648	358	1062	97	73	26				
4x3	12.000	147	293	461	275	622	355	252	744	439	972	537	1623	146	110	39				
4x4	16.000	196	391	614	366	829	473	336	992	585	1296	716	2164	194	146	51				
4x5	20.000	245	488	768	458	1037	592	420	1240	731	1620	895	2705	243	183	64				
6x4	24.000	294	586	921	549	1244	710	504	1488	878	1944	1074	3246	291	219	77				

Not all sizes available for each duct type (see pg. 36 for color and size chart).

### Formula used to calculate fill capacity:

$$\text{Number of Wires} = \frac{\text{Duct W x H}}{1.75 \times (\text{Wire O.D.})^2}$$

### Formula to approximate wiring duct size needed:

#### Wire O.D. for multiple wire types:

$$\text{Wire O.D.} = \frac{\sum(\text{Number of Wires} \times \text{Wire O.D.})}{\text{Number of Wires}}$$

Example:

15 wires with .165 O.D.=15 x .165 = 2.475  
 28 wires with .065 O.D.=28 x .065 = 1.820  
 16 wires with .125 O.D.=16 x .125 = 2.000  
 59 total wires = 6.295

$$6.295 \div 59 = \text{Wire O.D.} = .107$$

1. Determine the **number of wires** the duct will need to hold.
2. Determine the **wire outside diameter** (for multiple wires see formula at left).
3. Calculate the necessary **wire area** using the following formula:

$$\text{Wire Area} = \text{Number of Wires} \times [1.75 \times (\text{Wire O.D.})^2]$$

Example: Wire Area = 59 X [1.75 X (.107)<sup>2</sup>] = 59 X .020 = **1.182**

4. **Choose a Duct** with W X H that is equal to or greater than the result from step 3.

$$\text{Selected Duct Area} \geq \text{Calculated Wire Area}$$

Example: For Duct Size .75 X 1.5 Duct Area= .75 X 1.5 = 1.125 No Good 1.125 < 1.182  
 For Duct Size 1.5 X 1.0 Duct Area= 1.5 X 1.0 = 1.500 Good 1.500 > 1.182

In the above example 1 x 1.5 duct or a larger duct size could also be used.

# PANDUCT® Type NE, NS, PE, PS, D, E & S—Wirefill

NOMINAL DUCT SIZE (W X H)	AREA in <sup>2</sup>	ELECTRICAL											CAT 5 CABLES					
		8 AWG		10 AWG		12 AWG		14 AWG			16 AWG		18 AWG		22 AWG	24 AWG		
		.216	.153	.122	.158	.105	.139	.165	.096	.125	.084	.113	.065	.217	.250	.422		
		THHN	THHN	THHN	MTW	THHN	MTW	MTW	TFFN	MTW	TFFN	MTW	MTW	UTP/ CM CAT 5	STP/ CM CAT 5	UTP/CM		
.5 x .5	0.250	3	5	8	5	11	6	5	14	8	18	10	30	3	2	1		
.5 x .62	0.310	3	7	10	6	14	8	6	17	10	22	12	37	3	2	1		
.5 x 1	0.500	5	11	17	10	23	13	9	27	16	35	20	59	5	4	1		
.5 x 1.25	0.625	7	13	21	13	28	16	11	34	20	44	24	74	7	5	2		
.5 x 1.75	0.875	9	19	29	18	40	23	16	47	28	62	34	104	9	7	2		
.5 x 2	1.000	11	21	34	20	45	26	18	54	32	71	39	118	11	8	3		
.75 x .75	0.563	6	12	19	11	26	15	10	31	18	40	22	67	6	5	2		
.75 x 1	0.750	8	16	25	15	34	19	14	41	24	53	29	89	8	6	2		
.75 x 1.5	1.125	12	24	38	23	51	29	21	61	36	80	44	133	12	9	3		
.75 x 2	1.500	16	32	50	30	68	39	28	81	48	106	59	178	16	12	4		
1 x 1	1.000	11	21	34	20	45	26	18	54	32	71	39	118	11	8	3		
1 x 1.25	1.250	13	27	42	25	57	32	23	68	40	89	49	148	13	10	4		
1 x 1.5	1.500	16	32	50	30	68	39	28	81	48	106	59	178	16	12	4		
1 x 2	2.000	21	43	67	40	91	52	37	109	64	142	78	237	21	16	6		
1 x 2.5	2.500	27	53	84	50	113	65	46	136	80	177	98	296	27	20	7		
1 x 3	3.000	32	64	101	60	136	78	55	163	96	213	117	355	32	24	8		
1 x 4	4.000	43	85	134	80	181	104	73	217	128	283	157	473	42	32	11		
1.5 x 1	1.500	16	32	50	30	68	39	28	81	48	106	59	178	16	12	4		
1.5 x 1.5	2.250	24	48	76	45	102	58	41	122	72	159	88	266	24	18	6		
1.5 x 2	3.000	32	64	101	60	136	78	55	163	96	213	117	355	32	24	8		
1.5 x 3	4.500	48	96	151	90	204	116	83	244	144	319	176	533	48	36	13		
1.5 x 4	6.000	64	128	202	120	272	155	110	326	192	425	235	710	64	48	17		
2 x 1	2.000	21	43	67	40	91	52	37	109	64	142	78	237	21	16	6		
2x1.5	3.000	32	64	101	60	136	78	55	163	96	213	117	355	32	24	8		
2x2	4.000	43	85	134	80	181	104	73	217	128	283	157	473	42	32	11		
2 x 2.5	5.000	54	107	168	100	227	129	92	271	160	354	196	592	53	40	14		
2 x 3	6.000	64	128	202	120	272	155	110	326	192	425	235	710	64	48	17		
2x4	8.000	86	171	269	160	363	207	147	434	256	567	313	947	85	64	22		
2 x 5	10.000	107	214	336	200	454	259	184	543	320	709	392	1183	106	80	28		
2.5 x 3	7.500	80	160	252	150	340	194	138	407	240	531	294	888	80	60	21		
3 x 1	3.000	32	64	101	60	136	78	55	163	96	213	117	355	32	24	8		
3 x 1.25	3.750	40	80	126	75	170	97	69	203	120	266	147	444	40	30	11		
3x2	6.000	64	128	202	120	272	155	110	326	192	425	235	710	64	48	17		
3x3	9.000	96	192	302	180	408	233	165	488	288	638	352	1065	96	72	25		
3x4	12.000	129	256	403	240	544	311	220	651	384	850	470	1420	127	96	34		
3x5	15.000	161	320	504	300	680	388	275	814	480	1063	587	1775	159	120	42		
4 x 1.5	6.000	64	128	202	120	272	155	110	326	192	425	235	710	64	48	17		
4x2	8.000	86	171	269	160	363	207	147	434	256	567	313	947	85	64	22		
4x3	12.000	129	256	403	240	544	311	220	651	384	850	470	1420	127	96	34		
4x4	16.000	171	342	537	320	726	414	294	868	512	1134	627	1893	170	128	45		
4x5	20.000	214	427	672	401	907	518	367	1085	640	1417	783	2367	212	160	56		

Not all sizes available for each duct type (see pg. 36 for color and size chart).

**Formula used to calculate fill capacity:**

$$\text{Number of Wires} = \frac{\text{Duct W x H}}{2.00 \times (\text{Wire O.D.})^2}$$

**Formula to approximate wiring duct size needed:**

**Wire O.D. for multiple wire types:**

$$\text{Wire O.D.} = \frac{\sum(\text{Number of Wires} \times \text{Wire O.D.})}{\text{Number of Wires}}$$

Example:

15 wires with .165 O.D. = 15 x .165 = 2.475  
 28 wires with .065 O.D. = 28 x .065 = 1.820  
 16 wires with .125 O.D. = 16 x .125 = 2.000  
 59 total wires = 6.295

$$6.295 \div 59 = \text{Wire O.D.} = \boxed{.107}$$

- Determine the **number of wires** the duct will need to hold.
- Determine the **wire outside diameter** (for multiple wires see formula at left).
- Calculate the necessary **wire area** using the following formula:  

$$\text{Wire Area} = \text{Number of Wires} \times [2 \times (\text{Wire O.D.})^2]$$

Example:  $\text{Wire Area} = 59 \times [2 \times (.107)^2] = 59 \times .023 = \boxed{1.357}$
- Choose a Duct** with W X H that is equal to or greater than the result from step 3.  

$$\text{Selected Duct Area} \geq \text{Calculated Wire Area}$$

Example: For Duct Size .75 X 1.5 Duct Area = .75 X 1.5 = 1.125 No Good 1.125 < 1.357  
 For Duct Size 1.5 X 1.0 Duct Area = 1.5 X 1.0 = 1.500 Good 1.500 > 1.357

In the above example 1 x 1.5 duct or a larger duct size could also be used.

# PANDUCT® Wiring Duct & Raceway—Physical Properties

PROPERTIES	UNITS	TEST METHOD	PVC	NORYL	POLYCARB.
<b>GENERAL</b>					
Specific Gravity	g/cc	ASTM D 792	1.38	1.08	1.21
Heat Deflection Temperature @264 psi	°F	ASTM D 648	163	212	270
Thermal Expansion	10 <sup>-5</sup> in/in/°F	ASTM D 696	3.7	3.8	3.9
Thermal Conductivity	(BTU-in/hr-ft <sup>2</sup> -F°)	ASTM C 177	1.3	1.1	1.4
Compressive Yield Strength	psi	ASTM D 695	8,100	12,000	11,000
<b>BURNING CHARACTERISTICS</b>					
Flammability Class	—	UL94	V-0	V-1	N/A
Smoke Density	—	ASTM E 662	538	N/A	108
Limited Oxygen Index (LOI)	—	ASTM D 2863	45	30	35
<b>HARDNESS</b>					
Durometer Hardness	“D”	ASTM D 2240	78	85	88
Rockwell Hardness	“R”	ASTM D 785	111	115	118
<b>TENSILE</b>					
Strength at Yield	psi	ASTM D 638	6,200	6,900	9,000
Modulus	psi	ASTM D 638	390,000	380,000	350,000
<b>FLEXURAL</b>					
Strength at Yield	psi	ASTM D 790	9,500	11,400	13,200
Modulus	psi	ASTM D 790	350,000	365,000	330,000
<b>IMPACT STRENGTH</b>					
Notched Izod (.125") at:		ASTM D 256			
23°C (73°F)	ft-lb/in		17.0	5.0	16.0
0°C (32°F)	ft-lb/in		1.6	N/A	N/A
-18°C (0°F)	ft-lb/in		1.1	N/A	N/A
Unnotched Modified Izod at:		ASTM D 256			
23°C (73°F)	ft-lb/in		>64.0	N/A	60.0
0°C (32°F)	ft-lb/in		>64.0	N/A	N/A
-18°C (0°F)	ft-lb/in		>42.0	N/A	N/A
<b>ELECTRICAL PROPERTIES</b>					
Power Factor:		ASTM D 150			
60 Hz @30°C (86°F)	—		2.90	N/A	N/A
1 MHz @30°C (86°F)	—		4.00	N/A	N/A
Dielectric Constant:		ASTM D 150			
60 Hz @30°C (86°F)	—		3.90	2.65	3.01
1 MHz @30°C (86°F)	—		3.30	N/A	2.96
Dielectric Strength:		ASTM D 149			
Normal	volts/mil		690	400	425
Moist	volts/mil		700	N/A	N/A

NOTE: To the best of our knowledge the above information is accurate, is based upon accepted technical practices and is believed to be reliable. Panduit assumes no liability for the accuracy or completeness of this information.

<p><b>Rigid Polyvinyl Chloride (PVC)</b></p> <p>A general purpose material for use in indoor applications. PVC has a UL flammability rating of V-0 and is UL Recognized for continuous use up to 50°C (122°F). PVC is an economical wiring duct material.</p> <p><b>Duct Types: G, F, FS, D, E &amp; S</b></p>	<p><b>NORYL®</b></p> <p>A special purpose material for use in halogen free, or high temperature applications. NORYL® has a UL flammability rating of V-1 and is UL Recognized for continuous use up to 95°C (203°F), and is 20% lighter than PVC.</p> <p><b>Duct Types: NE &amp; NS</b></p>	<p><b>POLYCARBONATE (PC)</b></p> <p>A special purpose material for use where low halogen and low smoke generation is critical. Ideally suited for transportation industry regulations. Polycarbonate has a recommended temperature use of up to 125°C (257°F), and is 14% lighter than PVC.</p> <p><b>Duct Types: PE &amp; PS</b></p>
--	---	---



# PANDUCT® Wiring Duct & Raceway—Physical Properties

## Flammability

This test method measures the comparative burning characteristics of solid plastic materials.

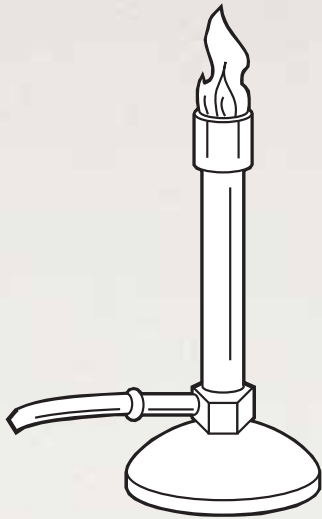

## UL Vertical Burning Test

Test samples measure 125mm by 13mm by the minimum thickness of the end product. Tests are conducted utilizing unaged samples (as manufactured) and aged samples (7 days @ 70°C, 158°F.) A standard test flame is applied for two 10 second applications to the unsupported end of a vertically clamped sample. The afterflame time is recorded following the first flame application. Both afterflame and afterglow times are recorded following the second flame application. Also observed and documented are, if the sample drips flaming particles that ignite the cotton layer below.

## Materials Classed V-0 (Criteria)\*

- Afterflame for each sample does not exceed 10 seconds following the removal of each flame application.
- Total afterflame time for a set of five samples following both flame applications is not greater than 50 seconds.
- Afterflame plus afterglow time for each sample does not exceed 30 seconds following the second flame application.
- A sample does not exhibit afterflame or afterglow up to the holding clamp.
- The cotton indicator below the sample does not ignite from flaming particles or droplets from the test sample.

## Materials Classed V-1 (Criteria)\*

- Not have any specimens which burn with flaming combustion for more than 30 seconds after either application of the test flame.
- Not have a total flaming combustion time exceeding 250 seconds for the 10 flame applications for each set of five specimens.
- Not have any specimens which burn with flaming or glowing combustion up to the holding clamp.
- Not have any specimens which drip flaming particles that ignite the dry absorbent surgical cotton located 12" (305mm) below the test specimen.
- Not have any specimens with glowing combustion which persists for more than 60 seconds after the second removal of the test flame.

\*The flammability rating determined from this method does not indicate its performance in end-use applications.

## Cutting Wiring Duct & Cover

For small quantities, use the DCT Duct Cutting Tool. For larger quantities use a plastic cutting saw blade for clean burr-free cuts. Recommend: Carbide 80T or 100T; 0.90" thickness, 0.125 kerf.

# PANDUCT® Wiring Duct & Raceway—Color Selection

DUCT SIZE (W X H) inches	LG	WH	DG	BL	CL	IB
	Light Gray	White	Dark Gray	Black	Clear	Intrinsic Blue
.5 x .5	G F FS E S	G F FS E S	G E S	E S		
.5 x.62	E S NE NS	E S NE NS	E S			
.5 x 1	G F FS E S NE NS	F FS E S NE NS	G E S			
.5 x 1.25	E S NE NS	G F FS E S NE NS	G FS E S			
.5 x 1.75	E S NE NS	G F FS E S NE NS	G FS E S			
.5 x 2	E S	G F FS E S	G FS E S			
.75 x .75	G F FS E S D	G F FS E S D	G FS E S	E S D		
.75 x 1	G FS E S D	G E S D	G FS E S	E S D	PE PS	
.75 x 1.5	G F FS E S D	G F FS E S D	G FS E S	E S D		
.75 x 2	G FS E S D	G FS E S D	G FS E S	E S D		
1 x 1	G F FS E S D NE NS	G F FS E S D NE NS	G FS E S	G FS E S D		G FS E S
1 x 1.25	E S	E S	E S			
1 x 1.5	G F FS E S D NE NS	G F FS E S D NE NS	G FS E S	G FS E S D		
1 x 2	G F FS E S D NE NS	G F FS E S D NE NS	G FS E S	G FS E S D		G FS E S
1 x 2.5	E S	E S	E S			
1 x 3	G F FS E S D NE NS	G F FS E S D NE NS	G FS E S	G FS E S D		
1 x 4	G FS E S D NE NS	G FS E S D NE NS	G FS E S	G FS E S D		
1.5 x 1	G F FS E S	G F FS E S	G FS E S			
1.5 x 1.5	G F FS E S D NE NS	G F FS E S D NE NS	G FS E S	G FS E S D	PE PS	
1.5 x 2	G F FS E S D NE NS	G F FS E S D NE NS	G FS E S	G FS E S D		G FS
1.5 x 3	G F FS E S D NE NS	G F FS E S D NE NS	G FS E S	G FS E S D		
1.5 x 4	G FS E S D NE NS	G FS E S D NE NS	G FS E S	G FS E S D		
2 x 1	G F FS E S D NE NS	G F FS E S D NE NS	G FS E S	G FS E S D		
2x1.5	G F FS E S	G F FS E S	G FS E S		PE PS	
2x2	G F FS E S D NE NS	G F FS E S D NE NS	G FS E S	G FS E S D	PE PS	G FS E S
2 x 2.5	E S	E S	E S			
2 x 3	G F FS E S D NE NS	G F FS E S D NE NS	G FS E S	G FS E S D		G FS E S
2x4	G FS E S D NE NS	G F FS E S D NE NS	G FS E S	G FS E S D		
2 x 5	G FS E S	G FS E S	G FS E S			
2.5 x 3	G FS E S D NE NS	G FS E S D NE NS	G FS E S	E S D		
3 x 1	G F FS E S D NE NS	G F FS E S D NE NS	G FS E S	G FS E S D		
3 x 1.25	E S D NE NS	E S D NE NS	E S	E S D	PE PS	
3x2	G F FS E S D NE NS	G F FS E S D NE NS	G FS E S	G FS E S D		
3x3	G F FS E S D NE NS	G F FS E S D NE NS	G FS E S	G FS E S D		G FS E S
3x4	G FS E S D NE NS	G FS E S D NE NS	G FS E S	G FS E S D		
3x5	G FS E S NE NS	G F FS E S D NE NS	G FS E S			
4 x 1.5	G FS E S D NE NS	G FS E S D NE NS	G FS E S			
4x2	G F FS E S D NE NS	G F FS E S D NE NS	G FS E S	G FS E S D		
4x3	G F FS E S D NE NS	G F FS E S D NE NS	G FS E S	G FS E S D		
4x4	G FS E S D NE NS	G FS E S D NE NS	G FS E S	G FS E S D	PE PS	G FS E S
4x5	G FS E S NE NS	G F FS E S D NE NS	G FS E S			
6x4	G FS	FS				

**Intrinsic Blue Color—IB**

Intrinsic Blue wiring duct is made from the same PVC material as our standard PVC duct. Intrinsic Blue is an internationally recognized standard Blue color that identifies the wiring inside the duct as “incapable of releasing sufficient electrical or thermal energy under normal or abnormal conditions to cause ignition of a specific hazardous atmospheric mixture in its most easily ignited concentrations.”\* This is excellent for use in electrical panels that are designed for Chemical Plants, Grain Elevators or wherever explosive gases may exist.

\*ISA-RD12.6 (Instrument Society of America)

# Alphabetical Part Number Index

C.5LG6.....4, 6, 8, 18, 20, 21	DJSP3LG-Q.....26	F2-C.....27	G1.5X1LG6.....4
C.75LG6.....4, 6, 8, 18, 20, 21	DJSP4LG-Q.....26	F2X1.5LG6.....6	G1.5X2LG6.....4
C1.5LG6.....4, 6, 8, 18, 20, 21	DNT-100.....23	F2X1LG6.....6	G1.5X3LG6.....4
C1LG6.....4, 6, 8, 18, 20, 21	E.5X.5LG6.....20	F2X2LG6.....6	G1.5X4LG6.....4
C2.5LG6.....4, 8, 18, 20, 21	E.5X.62LG6.....20	F2X3LG6.....6	G1X1.5LG6.....4
C2LG6.....4, 6, 8, 18, 20, 21	E.5X1.25LG6.....20	F2X4LG6.....6	G1X1LG6.....4
C3LG6.....4, 6, 8, 18, 20, 21	E.5X1.75LG6.....20	F2X5LG6.....6	G1X2LG6.....4
C4LG6.....4, 6, 8, 18, 20, 21	E.5X1LG6.....20	F3-C.....27	G1X3LG6.....4
C6LG6.....4, 8	E.5X2LG6.....20	F3X1LG6.....6	G1X4LG6.....4
CS1BL6.....26	E.75X.75LG6.....20	F3X2LG6.....6	G2.5X3LG6.....4
CS1DG6.....26	E.75X1.5LG6.....20	F3X3LG6.....6	G2X1.5LG6.....4
CS1LG6.....26	E.75X1LG6.....20	F3X4LG6.....6	G2X1LG6.....4
CS1WH6.....26	E.75X2LG6.....20	F3X5LG6.....6	G2X2LG6.....4
CSP1.5LG-Q.....26	E1.5X1.5LG6.....20	F4-C.....27	G2X3LG6.....4
CSP1LG-Q.....26	E1.5X1LG6.....20	F4X2LG6.....6	G2X4LG6.....4
CSP2LG-Q.....26	E1.5X2LG6.....20	F4X3LG6.....6	G2X5LG6.....4
CSP3LG-Q.....26	E1.5X3LG6.....20	F4X4LG6.....6	G3X1LG6.....4
CSP4LG-Q.....26	E1.5X4LG6.....20	F4X5LG6.....6	G3X2LG6.....4
D.75X.75LG6.....18	E1X1.25LG6.....20	FS.5X.5LG6NM.....8	G3X3LG6.....4
D.75X1.5LG6.....18	E1X1.5LG6.....20	FS.5X1LG6NM.....8	G3X4LG6.....4
D.75X1LG6.....18	E1X1LG6.....20	FS.75X.75LG6NM.....8	G3X5LG6.....4
D1.5H6.....24	E1X2.5LG6.....20	FS.75X1.5LG6NM.....8	G4X1.5LG6.....4
D1.5X1.5LG6.....18	E1X2LG6.....20	FS.75X1LG6NM.....8	G4X2LG6.....4
D1.5X2LG6.....18	E1X3LG6.....20	FS.75X2LG6NM.....8	G4X3LG6.....4
D1.5X3LG6.....18	E1X4LG6.....20	FS1.5X1.5LG6NM.....8	G4X4LG6.....4
D1.5X4LG6.....18	E2.5X3LG6.....20	FS1.5X1LG6NM.....8	G4X5LG6.....4
D1H6.....24	E2X1.5LG6.....20	FS1.5X2LG6NM.....8	G6X4LG6.....4
D1X1.5LG6.....18	E2X1LG6.....20	FS1.5X3LG6NM.....8	NC.5LG6.....10, 12
D1X1LG6.....18	E2X2.5LG6.....20	FS1.5X4LG6NM.....8	NC1.5LG6.....10, 12
D1X2LG6.....18	E2X2LG6.....20	FS1X1.5LG6NM.....8	NC1LG6.....10, 12
D1X3LG6.....18	E2X3LG6.....20	FS1X1LG6NM.....8	NC2.5LG6.....10, 12
D1X4LG6.....18	E2X4LG6.....20	FS1X2LG6NM.....8	NC2LG6.....10, 12
D2.5X3LG6.....18	E2X5LG6.....20	FS1X3LG6NM.....8	NC3LG6.....10, 12
D2H6.....24	E3X1.25LG6.....20	FS1X4LG6NM.....8	NC4LG6.....10, 12
D2X1LG6.....18	E3X1LG6.....20	FS2.5X3LG6NM.....8	NE.5X.5WH6.....10
D2X2LG6.....18	E3X2LG6.....20	FS2X1.5LG6NM.....8	NE.5X.62LG6.....10
D2X3LG6.....18	E3X3LG6.....20	FS2X1LG6NM.....8	NE.5X1.25LG6.....10
D2X4LG6.....18	E3X4LG6.....20	FS2X2LG6NM.....8	NE.5X1.75LG6.....10
D3H6.....24	E3X5LG6.....20	FS2X3LG6NM.....8	NE.5X1LG6.....10
D3X1.25LG6.....18	E4X1.5LG6.....20	FS2X4LG6NM.....8	NE1.5X1.5LG6.....10
D3X1LG6.....18	E4X2LG6.....20	FS2X5LG6NM.....8	NE1.5X1WH6.....10
D3X2LG6.....18	E4X3LG6.....20	FS3X1LG6NM.....8	NE1.5X2LG6.....10
D3X3LG6.....18	E4X4LG6.....20	FS3X2LG6NM.....8	NE1.5X3LG6.....10
D3X4LG6.....18	E4X5LG6.....20	FS3X3LG6NM.....8	NE1.5X4LG6.....10
D4H6.....24	F.5X.5LG6.....6	FS3X4LG6NM.....8	NE1X1.5LG6.....10
D4X1.5LG6.....18	F.5X1LG6.....6	FS3X5LG6NM.....8	NE1X1LG6.....10
D4X2LG6.....18	F.75X.75LG6.....6	FS4X1.5LG6NM.....8	NE1X2LG6.....10
D4X3LG6.....18	F.75X1.5LG6.....6	FS4X2LG6NM.....8	NE1X3LG6.....10
D4X4LG6.....18	F1-C.....27	FS4X3LG6NM.....8	NE1X4LG6.....10
DB-C.....24	F1.5-C.....27	FS4X4LG6NM.....8	NE2.5X3LG6.....10
DCT.....23	F1.5X1.5LG6.....6	FS4X5LG6NM.....8	NE2X1.5WH6.....10
DCT-BLD.....23	F1.5X1LG6.....6	FS6X4LG6NM.....8	NE2X1LG6.....10
DCT-RI.....23	F1.5X2LG6.....6	FWR-C.....25, 28	NE2X2LG6.....10
DJS1BL6.....26	F1.5X3LG6.....6	G.5X.5LG6.....4	NE2X3LG6.....10
DJS1DG6.....26	F1.5X4LG6.....6	G.5X1LG6.....4	NE2X4LG6.....10
DJS1LG6.....26	F1X1.5LG6.....6	G.75X.75LG6.....4	NE3X1LG6.....10
DJS1WH6.....26	F1X1LG6.....6	G.75X1.5LG6.....4	NE3X2LG6.....10
DJSP1.5LG-Q.....26	F1X2LG6.....6	G.75X1LG6.....4	NE3X3LG6.....10
DJSP1LG-Q.....26	F1X3LG6.....6	G.75X2LG6.....4	NE3X4LG6.....10
DJSP2LG-Q.....26	F1X4LG6.....6	G1.5X1.5LG6.....4	NE3X5LG6.....10



# Alphabetical Part Number Index

NE4X2LG6.....	10	PE3X1.25CL6.....	14	S4F-C.....	27
NE4X3LG6.....	10	PE4X4CL6.....	14	S4X1.5LG6NM.....	21
NE4X4LG6.....	10	PFX-0.....	28	S4X2LG6NM.....	21
NE4X5LG6.....	10	PFX-2.....	28	S4X3LG6NM.....	21
NR1-C.....	23	PS.75X1CL6NM.....	16	S4X4LG6NM.....	21
NR1-M.....	23	PS1.5X1.5CL6NM.....	16	S4X5LG6NM.....	21
NS.5X.5WH6NM.....	12	PS2X1.5CL6NM.....	16	SD2H6.....	24
NS.5X.62LG6NM.....	12	PS2X2CL6NM.....	16	SD3H6.....	24
NS.5X1.25LG6NM.....	12	PS3X1.25CL6NM.....	16	SD4H6.....	24
NS.5X1.75LG6NM.....	12	PS4X4CL6NM.....	16	SNS.5-C.....	27
NS.5X1LG6NM.....	12	PX-0.....	28	SNS.75-C.....	27
NS1.5X1.5LG6NM.....	12	PX-2.....	28	SNS1-C.....	27
NS1.5X1WH6NM.....	12	S.5-C.....	27	SNS1.5-C.....	27
NS1.5X2LG6NM.....	12	S.5X.5LG6NM.....	21	SNS1.5F-C.....	27
NS1.5X3LG6NM.....	12	S.5X.62LG6NM.....	21	SNS1F-C.....	27
NS1.5X4LG6NM.....	12	S.5X1.25LG6NM.....	21	SNS2-C.....	27
NS1X1.5LG6NM.....	12	S.5X1.75LG6NM.....	21	SNS2.5-C.....	27
NS1X1LG6NM.....	12	S.5X1LG6NM.....	21	SNS2F-C.....	27
NS1X2LG6NM.....	12	S.5X2LG6NM.....	21	SNS3-C.....	27
NS1X3LG6NM.....	12	S.75-C.....	27	SNS3F-C.....	27
NS1X4LG6NM.....	12	S.75X.75LG6NM.....	21	SNS4-C.....	27
NS2.5X3LG6NM.....	12	S.75X1.5LG6NM.....	21	SNS4F-C.....	27
NS2X1.5WH6NM.....	12	S.75X1LG6NM.....	21	T3WR-C.....	25
NS2X1LG6NM.....	12	S.75X2LG6NM.....	21	TNR.....	23
NS2X2LG6NM.....	12	S1-C.....	27	WR2-C.....	25
NS2X3LG6NM.....	12	S1.5-C.....	27	WR3-C.....	25
NS2X4LG6NM.....	12	S1.5F-C.....	27	WR4-C.....	25
NS3X1LG6NM.....	12	S1.5X1.5LG6NM.....	21	WR5-C.....	25
NS3X2LG6NM.....	12	S1.5X1LG6NM.....	21	WRS-A-C10.....	25
NS3X3LG6NM.....	12	S1.5X2LG6NM.....	21		
NS3X4LG6NM.....	12	S1.5X3LG6NM.....	21		
NS3X5LG6NM.....	12	S1.5X4LG6NM.....	21		
NS4X2LG6NM.....	12	S1F-C.....	27		
NS4X3LG6NM.....	12	S1X1.25LG6NM.....	21		
NS4X4LG6NM.....	12	S1X1.5LG6NM.....	21		
NS4X5LG6NM.....	12	S1X1LG6NM.....	21		
P32W2A2-50-7.....	22	S1X2.5LG6NM.....	21		
P32W2A2-50-7.....	22	S1X2LG6NM.....	21		
P32W2A2-50-7.....	22	S1X3LG6NM.....	21		
P32W2A2-50-72.....	22	S1X4LG6NM.....	21		
P32W2A2-50-72.....	22	S2-C.....	27		
P32W2A2-50-72.....	22	S2.5-C.....	27		
P32W2A2-75-7.....	22	S2.5X3LG6NM.....	21		
P32W2A2-75-7.....	22	S2F-C.....	27		
P32W2A2-75-72.....	22	S2X1.5LG6NM.....	21		
P32W2A2-75-72.....	22	S2X1LG6NM.....	21		
PC.75CL6.....	14, 16	S2X2.5LG6NM.....	21		
PC1.5CL6.....	14, 16	S2X2LG6NM.....	21		
PC1CL6.....	14	S2X3LG6NM.....	21		
PC2CL6.....	14, 16	S2X4LG6NM.....	21		
PC3CL6.....	14, 16	S2X5LG6NM.....	21		
PC4CL6.....	14, 16	S3-C.....	27		
PDL-110-1.....	28	S3F-C.....	27		
PDL-111-1.....	28	S3X1.25LG6NM.....	21		
PDL-PB1.....	28	S3X1LG6NM.....	21		
PE.75X1CL6.....	14	S3X2LG6NM.....	21		
PE1.5X1.5CL6.....	14	S3X3LG6NM.....	21		
PE1X2CL6.....	14	S3X4LG6NM.....	21		
PE2X1.5CL6.....	14	S3X5LG6NM.....	21		
PE2X2CL6.....	14	S4-C.....	27		

# NOTES

**PANDUIT *PANDUCT*® Wiring Duct is Part of the Full Line of Wiring and Communication Products**

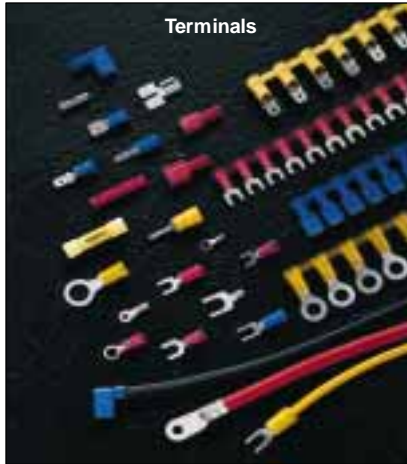

Ask for Terminal Catalog  
SA101N21B-NL



Ask for Power Connector  
Catalog SA101N15C-NL



Ask for Cable Ties/Wiring  
Accessories Catalog  
SA101N275C-WC



Ask for **PAN-STEEL™** System  
Catalog SA101N16G

Also Ask for Electrical  
Condensed Catalog  
SA101N13J



Ask for Abrasion Protection  
Catalog SA101N48D



Ask for Communication  
Products Catalog  
SA101N152E-OP



Ask for **PAN-WAY™** Surface  
Raceway Catalog  
SA101N60A



Ask for **PAN-CODE™** Catalog  
SA101N315A-ID