



LVC MOS VCXO Specification Model V803

CONNOR WINFIELD



2111 Comprehensive Drive

Aurora, Illinois 60505

Phone: 630-851-4722

Fax: 630-851-5040

www.conwin.com

Description:

The Connor-Winfield, RoHS compliant, V803 is a 3.3V Voltage Controlled Crystal Oscillator (VCXO) with LVC MOS output and enable/disable function. The V803 is designed for use with applications utilizing a PLL system requiring low jitter and tight frequency stability.



Features:

- 3.3 Vdc Operation
- Absolute Pull Range (APR): ± 50 ppm
- Temperature Range: 0 to 70°C
- Low Jitter: <1ps RMS
- LVC MOS Output
- 5x7 mm SMT Package
- Vc has High Input Resistance, Pad 1
- Tri-State Enable/Disable, Pad 2
- Tape and Reel Packaging
- RoHS Compliant / Lead Free

Absolute Maximum Ratings

Parameter	Minimum	Nominal	Maximum	Units	Notes
Storage Temperature	-40	-	85	°C	
Supply Voltage (Vcc)	-0.5	-	4.6	Vdc	
Control Voltage (Vc)	-0.5	-	Vcc + 0.5	Vdc	

Operating Specifications

Parameter	Minimum	Nominal	Maximum	Units	Notes
Center Frequency: (Fo)	27	-	140	MHz	
Operating Temp Range:	0	-	70	°C	
Supply Voltage: (Vcc)	3.135	3.3	3.465	Vdc	
Supply Current : (Icc)	-	-	30	mA	
Jitter:					
Period Jitter	-	3.0	5.0	ps RMS	
Integrated Phase Jitter	-	0.5	1.0	ps RMS	1
Typical SSB Phase Noise @ 100 MHz					
@ 10 Hz offset	-	-60	-	dBc/Hz	
@ 100 Hz offset	-	-90	-	dBc/Hz	
@ 1 KHz offset	-	-122	-	dBc/Hz	
@ 10 KHz offset	-	-140	-	dBc/Hz	
@ 100 KHz offset	-	-154	-	dBc/Hz	
@ 1 MHz offset	-	-160	-	dBc/Hz	
Start-Up Time	-	-	10	ms	

Input Characteristics

Parameter	Minimum	Nominal	Maximum	Units	Notes
Control Voltage Range (Vc)	0.3	1.65	3.0	Vdc	
Absolute Pull Range (APR)	± 50	-	-	ppm	2
Monotonic Linearity	-10	-	10	%	
DC Input Impedance	2M	-	-	Ohm	3
Modulation Bandwidth (3dB)	25	-	-	KHz	
Enable Input Voltage (High) (Vih)	2.4	-	-	V	4
Disable Input Voltage (Low) (Vil)	-	-	0.4	V	4

LVC MOS Output Characteristics

Parameter	Minimum	Nominal	Maximum	Units	Notes
Load	-	15	-	pF	
Voltage (High) Voh	2.4	-	-	V	
(Low) Vol	-	-	0.4	V	
Current (High) Ioh	-4	-	-	mA	
(Low) Iol	-	-	4	mA	
Duty Cycle at 50% Level	45	50	55	%	
Rise / Fall Time: 20% to 80%	-	-	2	ns	

Notes:

1. BW= 12 KHz to 20 MHz,
2. Absolute Pull Range (APR) is the minimum guaranteed pull range of the VCXO under all conditions over lifetime operation including calibration @ 25°C, frequency stability vs. the change in temperature, frequency vs. change in supply voltage, frequency vs. change in load, shock and vibration and 10 years aging. The APR is referenced to (Fo). Positive transfer function.
3. Measured from pin 1 to ground.
4. Oscillator output is enabled with no connection on pad 2.

** Not all frequency options available at Digi-Key



Package Characteristics

Package: Hermetically sealed ceramic surface mount package with case ground metal cover
Moisture Sensitivity Level: MSL-1

Environmental Characteristics

Vibration: Vibration per Mil Std 883E Method 2007.3 Test Condition A.
Shock: Mechanical Shock per Mil Std 883E Method 2002.4 Test Condition B.
Soldering Process: RoHS compliant lead free. See soldering profile below.

Package Layout

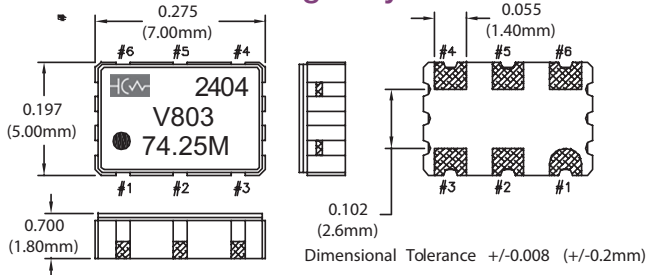

Typical Phase Noise

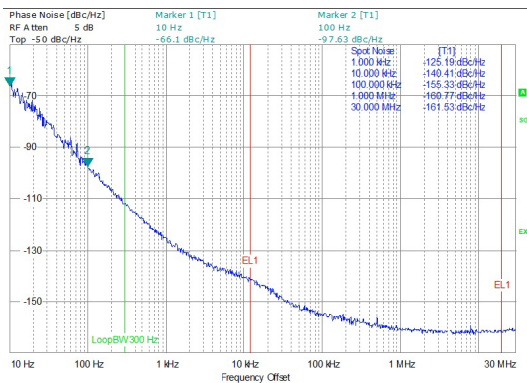

Test Circuit

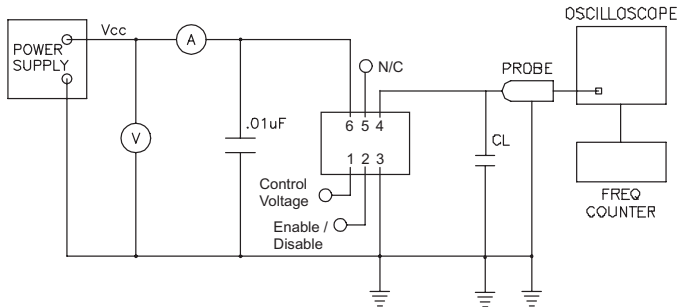

Tape and Reel Dimensions

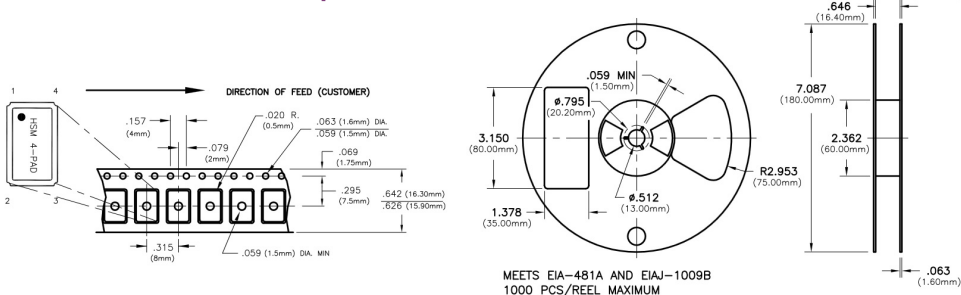

Ordering Information

V803 - 074.25M

VCXO SERIES CENTER FREQUENCY

Suggested Pad Layout

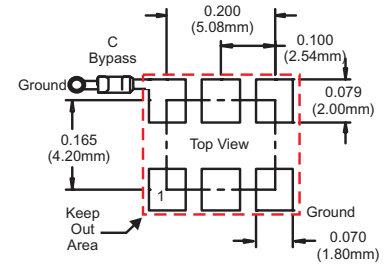

Pad Connections

- 1: Control Voltage (Vc)
- 2: Enable / Disable
- 3: Ground
- 4: Output Q
- 5: N/C
- 6: Supply Voltage (Vcc)

Enable / Disable Function

Function: Outputs
High or Open Enabled
Low Disabled (High Impedance)

Output Waveform

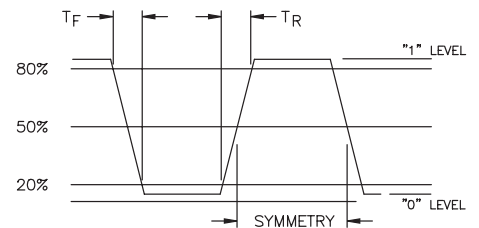

Solder Profile

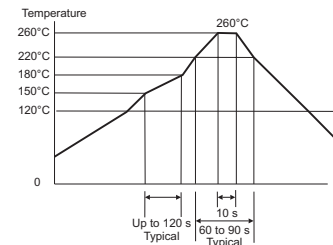

Meets IPC/JEDEC J-STD-020C

Bulletin **VX545**
Page **2 of 2**
Revision **06**
Date **03 July 2024**