

DO NOT SCALE FROM THIS PRINT

TSW-XXX-XX-XXX-X-XX-XXX

TABLE 2	
BODY SPECIFICATION	
ROW/OPTION	USE BODY
-S, -S-NA/-NE	TSW-50-S
-S-RA/-RE	TSW-50-S-RA
-D, -D-NA/-NE	RTSW-50-D
-D-RA	TSW-50-D-RA
-T, -T-NA/-NE	TSW-50-T
-T-RA, -Q-RA	TSW-50-T-RA
-Q	TSW-50-T

TERMINAL SPACE SPEC.
(SEE ASSEMBLY INSTRUCTIONS)
-1= .100[2.54] FILL EVERY POSITION
-2= .200[5.08] FILL EVERY OTHER POS. STARTING W/ 1ST & ENDING W/ LAST POS. IN BODY)

BODY LENGTH SPEC.
EXPRESSED IN # OF POS
-1: -01 THRU -50 (-S, -D, -T)
"A" = NO. OF POS. x .100[2.54]
-2: -02 THRU -25 (-S, -D, -T)
"A" = NO OF POS. x .200[5.08] - .100[2.54]

LEAD STYLE
SEE TABLE 1

PLATING SPECIFICATION

- G: 10µ" GOLD IN CONTACT AREA, 3µ" GOLD ON TAIL
- T: MATTE TIN CONTACT AND TAIL
- S: 30µ" SELECTIVE GOLD IN CONTACT AREA, MATTE TIN ON TAIL
- H: 30µ" HEAVY GOLD IN CONTACT AREA, 3µ" GOLD ON TAIL
- L: 10µ" LIGHT SELECTIVE GOLD IN CONTACT AREA, MATTE TIN ON TAIL
- F: 3µ" FLASH SELECTIVE GOLD IN CONTACT AREA, MATTE TIN ON TAIL
- E: 50µ" EXTRA HEAVY GOLD IN CONTACT AREA, 3µ" GOLD ON TAIL (-07, -08, -09, -13, -14, -15, -16, -20, -21 ONLY)
- TL: TIN/LEAD (90/10 +/-5%) CONTACT AND TAIL (AVAILABLE ONLY ON LEAD STYLES -07, -08 & -09)
- STL: 30µ" SELECTIVE GOLD IN CONTACT AREA, TIN/LEAD (90/10 +/-5%) TAIL (AVAILABLE ONLY ON LEAD STYLES -07, -08, -10, -15, -16, -17, -21, -23 & -24)
- TM: MATTE TIN CONTACT AND TAIL
- SM: 30µ" SELECTIVE GOLD IN CONTACT AREA, MATTE TIN ON TAIL
- LM: 10µ" LIGHT SELECTIVE GOLD IN CONTACT AREA, MATTE TIN ON TAIL
- FM: 3µ" FLASH SELECTIVE GOLD IN CONTACT AREA, MATTE TIN ON TAIL
- SS: 30µ" STRIPE SELECTIVE GOLD IN CONTACT AREA, MATTE TIN ON TAIL (SEE NOTE 13)
- GF: 3µ" GOLD OVER THE ENTIRE PIN

OPTION #2
-POLARIZING SPECIFICATION
XXX INDICATES POS. TO BE OMITTED (SEE FIG 3)

OPTION #1
-BLANK= STRAIGHT
-RA= RIGHT ANGLE (SEE TABLE 3 & 5, FIG 5) (-RA OPTION WITH -LL OPTION EQUALS TO -LA OPTION)
-RE= EXTENDED RIGHT ANGLE (SEE TABLE 3 & 5, FIG 5) (SINGLE ROW ONLY)
-NA= RA OPTION WITH STRAIGHT OPTION BODY (-NA OPTION WITH -LL OPTION IS VALID)
-NE= RE OPTION WITH STRAIGHT OPTION BODY
-LC= LOCKING CLIP (USE LTC-01 FOR -S ROW AND LTC-02 FOR -D ROW) (STYLES 08 THRU 13 & 22 ONLY) (SEE FIG 2) (N/A IN -RA OR -RE OPTION AND/OR LESS THAN 4 POSITIONS) (N/A IN -T OR -Q)
-LA= -RA OPTION WITH -LL OPTION (SEE FIG 5)
-LL= LOCKING LEAD (SEE FIG 4) (N/A WITH -RE OR -NE OPTION) (N/A IN SINGLE ROW, 1 OR 2 POSITIONS)

ROW SPECIFICATION (SEE TABLE 2)

- S: SINGLE
- D: DOUBLE
- T: TRIPLE
- Q: TRIPLE ROW, FILL OUTER ROWS ONLY

NOTES:

1. Ⓢ REPRESENTS CRITICAL DIMENSION.
2. MINIMUM TERMINAL PUSHOUT: 3 LBS.
3. MAXIMUM HEIGHT VARIATION: .005[0.13] (-RA TAIL N/A).
4. ASSEMBLE GOLD PLATE END AS SHOWN.
5. STYLE -26: ROUND END TO APPEAR ON BOTTOM.
6. C±^{0.05[0.13]}_{0.008[0.20]} FOR STYLE -08, OPTION -LA & -RA ONLY.
7. TOW & SWAY SPEC. OF 2° APPLIES TO ALL POSITIONS, POST & TAIL, IN ALL DIRECTIONS.
8. ALL DIMENSIONS TO BE ABOUT CL WITHIN ±.005[0.13].
9. MEASURE FROM THE BEND RADIUS OF THE TERMINALS.
10. TSW-50-D BODY CAN BE USED IF RTSW-50-D IS UNAVAILABLE
11. ORIENTATE PINS TO PREVENT BANDOLIERS MARKS FROM SHOWING IN THE POST AREA. (SEE TABLE 7)
12. MAXIMUM CUT FLASH: .020[0.50]
13. -SS OPTION ONLY AVAILABLE IN STRAIGHT LEAD STYLES -07, -08 & -09, -RA STYLE -08 ONLY. CAN ONLY MATE WITH SSW, SSQ, SSM, ESW, ESQ AND BCS.

UNLESS OTHERWISE SPECIFIED, DIMENSIONS ARE IN INCHES.

TOLERANCES ARE:

DECIMALS	ANGLES
.XX: .01[0.3]	2
.XXX: .005[0.13]	
.XXXX: .0020[0.051]	

PROPRIETARY NOTE

THIS DOCUMENT CONTAINS CONFIDENTIAL AND PROPRIETARY INFORMATION AND ALL DESIGN, MANUFACTURING, REPRODUCTION, USE, PATENT RIGHTS AND SALES RIGHTS ARE EXPRESSLY RESERVED BY SAMTEC, INC. THIS DOCUMENT SHALL NOT BE DISCLOSED, IN WHOLE OR PART, TO ANY UNAUTHORIZED PERSON OR ENTITY NOR REPRODUCED, TRANSFERRED OR INCORPORATED IN ANY OTHER PROJECT IN ANY MANNER WITHOUT THE EXPRESS WRITTEN CONSENT OF SAMTEC, INC.



520 PARK EAST BLVD, NEW ALBANY, IN 47150
PHONE: 812-944-6733 FAX: 812-948-5047
e-Mail info@SAMTEC.com code 55322

MATERIAL: DO NOT SCALE DRAWING SHEET SCALE: 3:1
BODIES: DUPONT PBT, UL 94 VO, COLOR: BLACK
TERMINALS: PHOS BRONZE

DESCRIPTION:
.025[0.64] SQ. POST TERMINAL STRIP ASSEMBLY

DWG. NO.
TSW-XXX-XX-XXX-X-XX-XXX

BY: KOLB 08/24/1988 SHEET 1 OF 6

TABLE 8	
ROW SPECIFICATION	OVERALL LENGTH
-Q, -T	"A" +.010/-.015 [+0.25/-0.38]
-S, -D	"A" +.015/-.015[+0.38/-0.38]

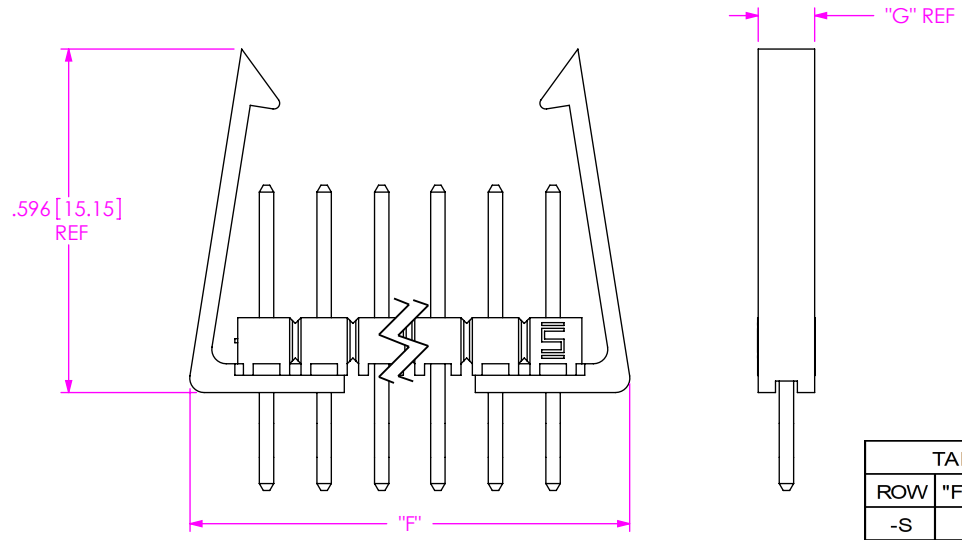
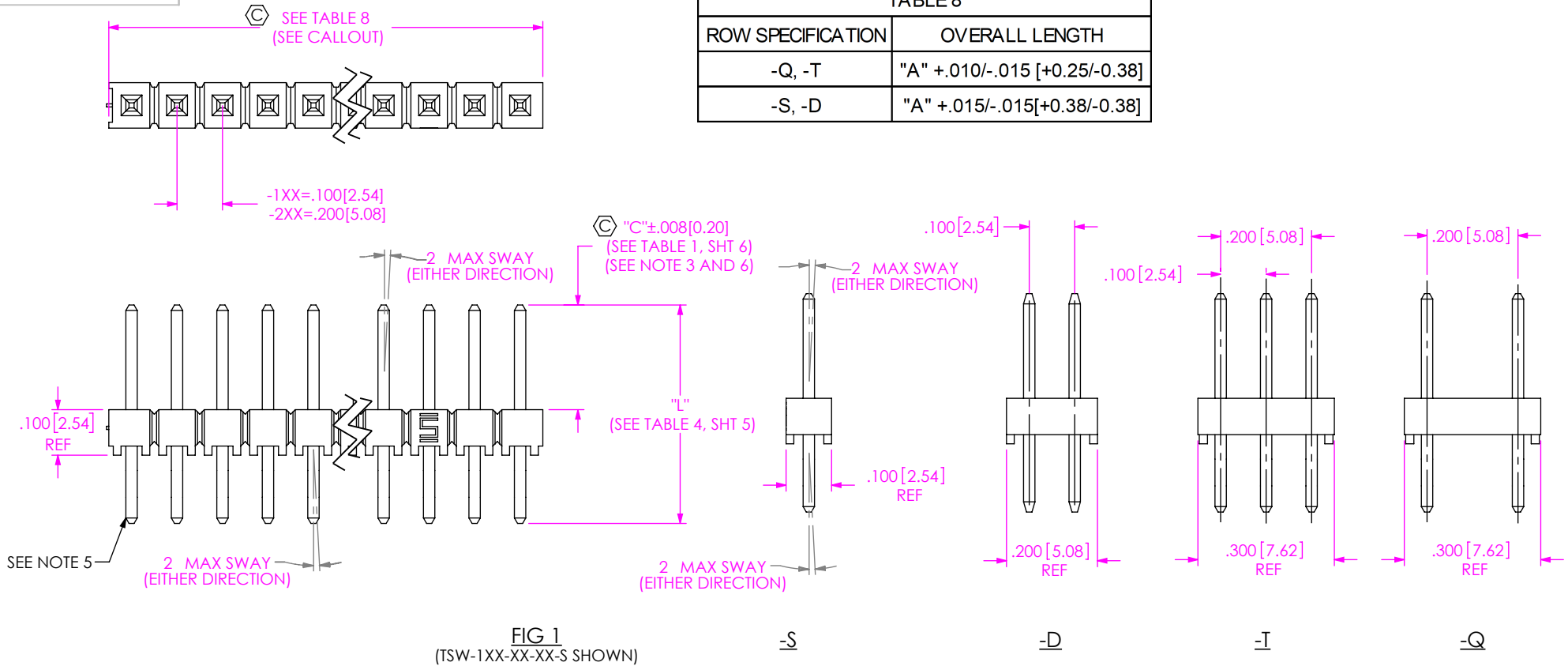

TABLE 6 -LC OPTION		
ROW	"F" ±.015[0.38]	"G"
-S	"A"±.150	.098[2.49]
-D	"A"±.210	.198[5.03]

PROPRIETARY NOTE
 THIS DOCUMENT CONTAINS CONFIDENTIAL AND PROPRIETARY INFORMATION AND ALL DESIGN, MANUFACTURING, REPRODUCTION, USE, PATENT RIGHTS AND SALES RIGHTS ARE EXPRESSLY RESERVED BY SAMTEC, INC. THIS DOCUMENT SHALL NOT BE DISCLOSED, IN WHOLE OR PART, TO ANY UNAUTHORIZED PERSON OR ENTITY NOR REPRODUCED, TRANSFERRED OR INCORPORATED IN ANY OTHER PROJECT IN ANY MANNER WITHOUT THE EXPRESS WRITTEN CONSENT OF SAMTEC, INC.

DO NOT SCALE DRAWING
 SHEET SCALE: 3:1



520 PARK EAST BLVD, NEW ALBANY, IN 47150
 PHONE: 812-944-6733 FAX: 812-948-5047
 e-Mail info@SAMTEC.com code 55322

DESCRIPTION:
 .025[0.64] SQ. POST TERMINAL STRIP ASSEMBLY
 DWG. NO.
TSW-XXX-XX-XXX-X-XX-XXX
 BY: KOLB 08/24/1988 SHEET 2 OF 6

FIG 3

-1: .100[2.54] TERMINAL SPACING
(SAME AS FIG 1, DIFFERENT AS SHOWN)

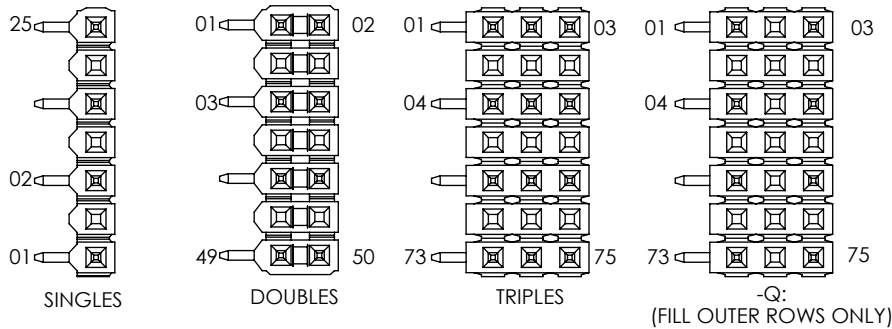
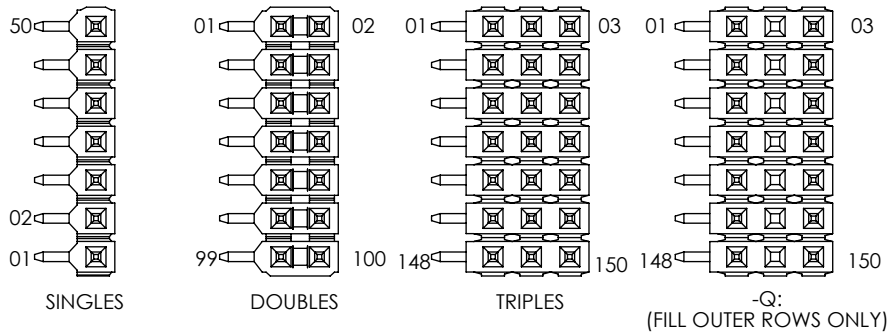

-2: .200[5.08] TERMINAL SPACING

FIG 4
LOCKING LEAD
(NOTE: END VIEWS SHOWN)
(SAME AS FIG 1, DIFFERENT AS SHOWN)

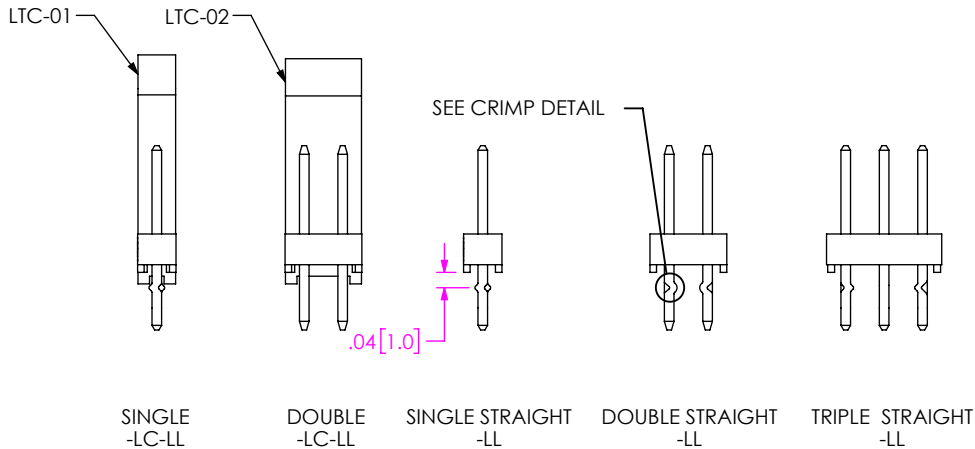

CRIMP DETAIL
SCALE: 4:1
(TYP ALL CRIMPS)

c:\enterprisevault\DWG\MISC\MKTG\TSW-XXX-XX-XXX-X-XX-XXX-MKT.SLDDRW

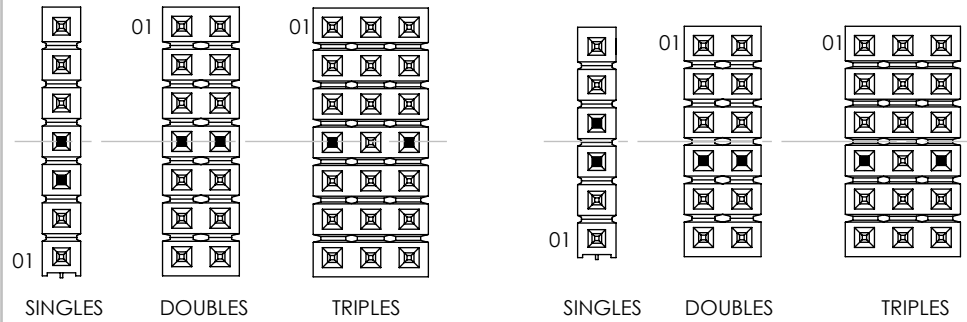

STRAIGHT VERSION
ODD POSITIONS

STRAIGHT VERSION
EVEN POSITIONS

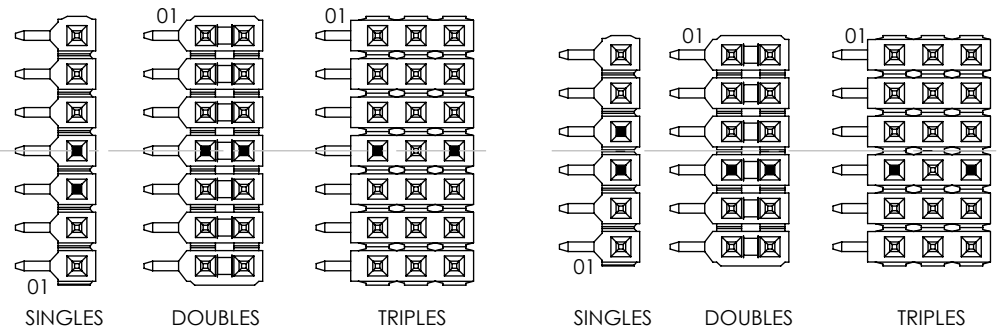

RIGHT ANGLE VERSION
ODD POSITIONS

RIGHT ANGLE VERSION
EVEN POSITIONS

LOCKING LEAD

■ = CRIMP LOCATION

TWO CENTER MOST PINS TO BE CRIMPED.

ODD POSITIONS, CRIMP CENTER POSITION AND POSITION CLOSEST TO PIN ONE.
IF CRIMP POSITION IS POLARIZED, MOVE ONE POSITION TOWARDS PIN ONE.

PROPRIETARY NOTE

THIS DOCUMENT CONTAINS CONFIDENTIAL AND PROPRIETARY INFORMATION AND ALL DESIGN, MANUFACTURING, REPRODUCTION, USE, PATENT RIGHTS AND SALES RIGHTS ARE EXPRESSLY RESERVED BY SAMTEC, INC. THIS DOCUMENT SHALL NOT BE DISCLOSED, IN WHOLE OR PART, TO ANY UNAUTHORIZED PERSON OR ENTITY NOR REPRODUCED, TRANSFERRED OR INCORPORATED IN ANY OTHER PROJECT IN ANY MANNER WITHOUT THE EXPRESS WRITTEN CONSENT OF SAMTEC, INC.

DO NOT SCALE DRAWING

SHEET SCALE: 2:1



520 PARK EAST BLVD, NEW ALBANY, IN 47150
PHONE: 812-944-6733 FAX: 812-948-5047
e-Mail info@SAMTEC.com code 55322

DESCRIPTION:
.025[0.64] SQ. POST TERMINAL STRIP ASSEMBLY

DWG. NO.
TSW-XXX-XX-XXX-X-XX-XXX

BY: KOLB 08/24/1988 SHEET 3 OF 6

FIG 5
 (RIGHT ANGLE)
 (-LA OPTION IS SHOWN ON ALL RIGHT ANGLES
 FOR DIMENSIONAL AND LOCATION PURPOSES.)
 (SEE CRIMP DETAIL VIEW, SHT 3)
 (SAME AS FIG 1, DIFFERENT AS SHOWN)

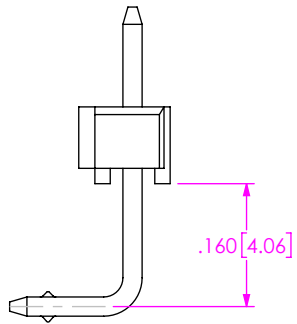
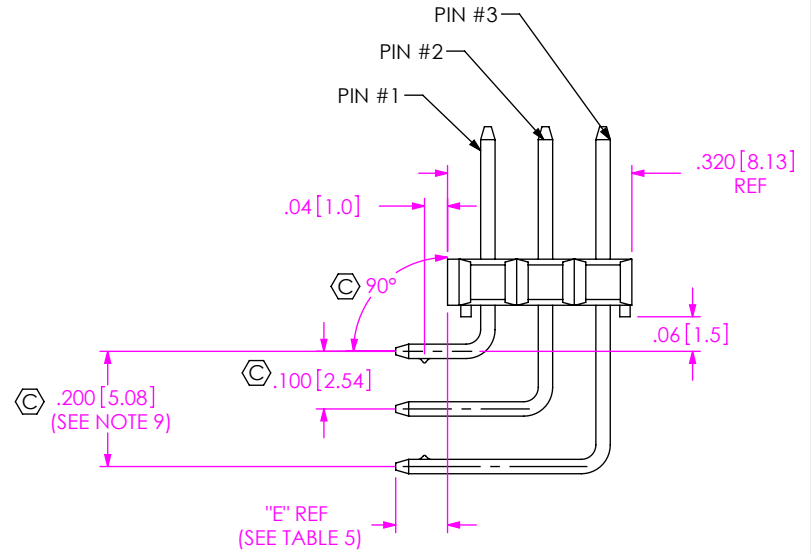
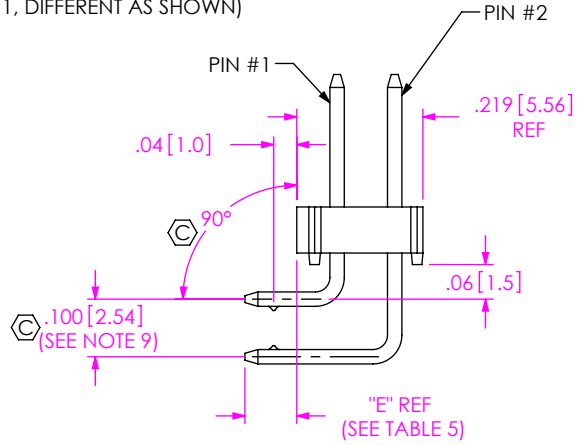
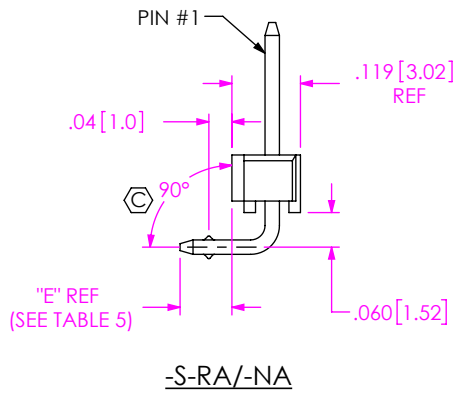

(SAME AS -S-RA/-NA VIEW, DIFFERENT AS SHOWN)

TABLE 5 "E"

LEAD STYL	RA SINGLE	RE SINGLE	RA DOUBLE	RA TRIPLE	NA SINGLE	NE SINGLE	NA DOUBLE	NA TRIPLE
08	.090 [2.29]	N/A	.090 [2.29]	.090 [2.29]	.109 [2.77]	N/A	.109 [2.77]	.109 [2.77]
09	.290 [7.37]	.190 [4.83]	.290 [7.37]	.290 [7.37]	.309 [7.85]	.209 [5.31]	.309 [7.85]	.309 [7.85]
10	.390 [9.91]	.290 [7.37]	.390 [9.91]	.390 [9.91]	.409 [10.39]	.309 [7.85]	.409 [10.39]	.409 [10.39]
11	.490 [12.45]	.390 [9.91]	.490 [12.45]	.490 [12.45]	.509 [12.93]	.409 [10.39]	.509 [12.93]	.509 [12.93]
12	.590 [14.99]	.490 [12.45]	.590 [14.99]	.590 [14.99]	.609 [15.47]	.509 [12.93]	.609 [15.47]	.609 [15.47]
13	.790 [20.07]	.690 [17.53]	.790 [20.07]	N/A	.809 [20.55]	.709 [18.01]	.809 [20.55]	N/A
16	.200 [5.08]	.100 [2.54]	.200 [5.08]	.200 [5.08]	.219 [5.56]	.119 [3.02]	.219 [5.56]	.219 [5.56]
21	.990 [25.15]	.890 [22.61]	N/A	N/A	1.009 [25.63]	.909 [23.09]	N/A	N/A
22	.190 [4.83]	.090 [2.29]	.190 [4.83]	.190 [4.83]	.209 [5.31]	.109 [2.77]	.209 [5.31]	.209 [5.31]
25	.100 [2.54]	N/A	.100 [2.54]	.100 [2.54]	.119 [3.02]	N/A	.119 [3.02]	.119 [3.02]
27	.890 [22.61]	.790 [20.07]	N/A	N/A	.909 [23.09]	.809 [20.55]	N/A	N/A
28	.690 [17.53]	.590 [14.99]	.690 [17.53]	N/A	.709 [18.01]	.609 [15.47]	.709 [18.01]	N/A
29	.800 [20.32]	N/A	N/A	N/A	.819 [20.80]	N/A	N/A	N/A
30	.600 [15.24]	N/A	.600 [15.24]	N/A	.619 [15.72]	N/A	.619 [15.72]	N/A

c:\enterprise\vault\DWG\MISC\MKTG\TSW-XXX-XX-XXX-X-XX-XXX-MKT.SLDDRW

PROPRIETARY NOTE
 THIS DOCUMENT CONTAINS CONFIDENTIAL AND PROPRIETARY INFORMATION AND ALL DESIGN, MANUFACTURING, REPRODUCTION, USE, PATENT RIGHTS AND SALES RIGHTS ARE EXPRESSLY RESERVED BY SAMTEC, INC. THIS DOCUMENT SHALL NOT BE DISCLOSED, IN WHOLE OR PART, TO ANY UNAUTHORIZED PERSON OR ENTITY NOR REPRODUCED, TRANSFERRED OR INCORPORATED IN ANY OTHER PROJECT IN ANY MANNER WITHOUT THE EXPRESS WRITTEN CONSENT OF SAMTEC, INC.

DO NOT SCALE DRAWING

SHEET SCALE: 3:1



520 PARK EAST BLVD, NEW ALBANY, IN 47150
 PHONE: 812-944-6733 FAX: 812-948-5047
 e-Mail info@SAMTEC.com code 55322

DESCRIPTION:
 .025[0.64] SQ. POST TERMINAL STRIP ASSEMBLY

DWG. NO.
TSW-XXX-XX-XXX-X-XX-XXX

BY: KOLB 08/24/1988 SHEET 4 OF 6

TABLE 7 (-T PLATING ONLY)

LEAD STYLE	NUMBER OF BAND MARKS ALLOWED IN POST AREA			LEAD STYLE	NUMBER OF BAND MARKS ALLOWED IN POST AREA		
	PIN #1	PIN #2	PIN #3		PIN #1	PIN #2	PIN #3
*-05	*0	N/A	N/A	*-17	2	N/A	N/A
-06	1	N/A	N/A	*-18	2	N/A	N/A
-07	1	N/A	N/A	*-19	2	N/A	N/A
-08	0	0	0	*-20	2	N/A	N/A
-08 RA	0	0	0	*-21	2	N/A	N/A
-09	0	0	0	-21-RA	0	N/A	N/A
-09 RA	0	0	0	-21-RE	0	N/A	N/A
-09-RE	0	0	0	-22	0	0	0
-10	0	0	0	-22-RA	0	0	0
-10-RA	0	0	0	-22-RE	0	0	0
-10-RE	0	0	0	-23	1	N/A	N/A
-11	0	0	0	-24	1	N/A	N/A
-11-RA	0	0	0	-25	1	1	1
-11-RE	0	0	0	*-25-RA	1	0	0
-12	0	0	0	*-26	1	N/A	N/A
-12-RA	0	0	0	*-27	0	N/A	N/A
-12-RE	0	0	0	*-27-RA	0	N/A	N/A
-13	0	0	N/A	*-27-RE	0	N/A	N/A
-13-RA	0	0	N/A	*-28	0	0	N/A
-13-RE	0	0	N/A	*-28-RA	0	0	N/A
-14	1	N/A	N/A	*-28-RE	0	0	N/A
*-15	2	N/A	N/A	*-29	1	N/A	N/A
*-16	1	1	1	*-29-RA	1	N/A	N/A
*-16-RA	1	1	1	*-30	1	1	N/A
*-16-RE	1	1	1	*-30-RA	1	1	N/A

* PINS TO BE FLIPPED OPPOSITE OF SELECTIVE PLATING BEFORE BEING INSERTED

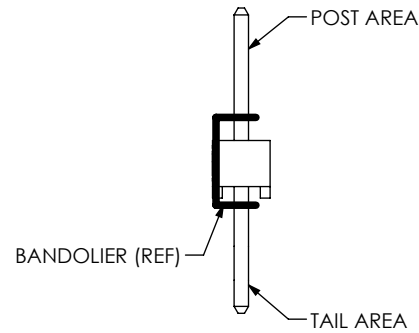

IN PROCESS 1
 (SAME AS FIG 1, DIFFERENT AS SHOWN)
 -T PLATING ONLY
 (SEE NOTE 11)
 (SEE TABLE 7)

TABLE 4

PIN STYLE	"L" REF
T-1S6-07-XXX-2	0.430 [10.92]
T-1S6-08-XXX-2	0.530 [13.46]
T-1S6-09-XXX-2	0.730 [18.54]
T-1S6-10-XXX-2	0.830 [21.08]
T-1S6-11-XXX-2	0.930 [23.62]
T-1S6-12-XXX-2	1.030 [26.16]
T-1S6-13-XXX-2	1.230 [31.24]
T-1S6-14-XXX-2	1.430 [36.32]
T-1S6-15-XXX-2	0.630 [16.00]
T-1S6-16-XXX-2	0.445 [11.30]
T-1S6-17-XXX-2	0.480 [12.19]
T-1S6-18-XXX-2	0.300 [7.62]
T-1S6-19-XXX-2	1.330 [33.78]
T-1S6-20-XXX-2	1.130 [28.70]
T-1S6-21-XXX-2	0.335 [8.51]
T-1RS7-01-XXX-2	0.456 [11.58]

PROPRIETARY NOTE
 * THIS DOCUMENT CONTAINS CONFIDENTIAL AND PROPRIETARY INFORMATION AND ALL DESIGN, MANUFACTURING, REPRODUCTION, USE, PATENT RIGHTS AND SALES RIGHTS ARE EXPRESSLY RESERVED BY SAMTEC, INC. THIS DOCUMENT SHALL NOT BE DISCLOSED, IN WHOLE OR PART, TO ANY UNAUTHORIZED PERSON OR ENTITY NOR REPRODUCED, TRANSFERRED OR INCORPORATED IN ANY OTHER PROJECT IN ANY MANNER WITHOUT THE EXPRESS WRITTEN CONSENT OF SAMTEC, INC.

DO NOT SCALE DRAWING

SHEET SCALE: 3:1



520 PARK EAST BLVD, NEW ALBANY, IN 47150
 PHONE: 812-944-6733 FAX: 812-948-5047
 e-Mail info@SAMTEC.com code 55322

DESCRIPTION:
 .025[0.64] SQ. POST TERMINAL STRIP ASSEMBLY

DWG. NO.
TSW-XXX-XX-XXX-X-XX-XXX

BY: KOLB 08/24/1988 SHEET 5 OF 6

TABLE 1				
TERMINAL SPECIFICATION				
LEAD STYLE	PIN #1	PIN #2	PIN #3	"C"
-05 (3)	T-1S6-21-XXX-2	N/A	N/A	0.105 [2.67] (5)
-06 (3)	T-1S6-18-XXX-2	N/A	N/A	0.105 [2.67] (5)
-07 (3)	T-1S6-07-XXX-2	N/A	N/A	0.230 [5.84] (5)
-08 (4)	T-1S6-08-XXX-2	T-1S6-09-XXX-2	T-1S6-11-XXX-2	(7)0.230 [5.84] (5)(6)
-09	T-1S6-09-XXX-2	T-1S6-11-XXX-2	T-1S6-20-XXX-2	0.230 [5.84] (6)
-10	T-1S6-10-XXX-2	T-1S6-12-XXX-2	T-1S6-13-XXX-2	0.230 [5.84]
-11	T-1S6-11-XXX-2	T-1S6-20-XXX-2	T-1S6-19-XXX-2	0.230 [5.84]
-12	T-1S6-12-XXX-2	T-1S6-13-XXX-2	T-1S6-14-XXX-2	0.230 [5.84]
-13	T-1S6-13-XXX-2	T-1S6-14-XXX-2	N/A	0.230 [5.84]
-14(3)	T-1S6-08-XXX-2	N/A	N/A	0.320 [8.13] (5)
-15 (3)	T-1S6-09-XXX-2	N/A	N/A	0.520 [13.21] (5)
-16	T-1S6-09-XXX-2	T-1S6-11-XXX-2	T-1S6-20-XXX-2	0.320 [8.13] (5)(6)
-17 (3)	T-1S6-10-XXX-2	N/A	N/A	0.620 [15.75] (5)
-18 (3)	T-1S6-11-XXX-2	N/A	N/A	0.720 [18.29] (5)
-19 (3)	T-1S6-12-XXX-2	N/A	N/A	0.820 [20.83] (5)
-20 (3)	T-1S6-13-XXX-2	N/A	N/A	1.020 [25.91] (5)
-21 (8)	T-1S6-14-XXX-2	N/A	N/A	1.220 [30.99] (5)
-21 (1)	T-1S6-14-XXX-2	N/A	N/A	0.230 [5.84] (5)
-22	T-1S6-15-XXX-2	T-1S6-10-XXX-2	T-1S6-12-XXX-2	0.230 [5.84] (5)(6)
-23 (3)	T-1S6-16-XXX-2	N/A	N/A	0.230 [5.84] (5)
-24 (3)	T-1S6-17-XXX-2	N/A	N/A	0.265 [6.73] (5)
-25 (4)	T-1S6-15-XXX-2	T-1S6-10-XXX-2	T-1S6-12-XXX-2	0.320 [8.13] (5)(6)
*-26 (3)	T-1RS7-01-XXX-2	N/A	N/A	0.230 [5.84]
-27	T-1S6-19-XXX-2	N/A	N/A	0.230 [5.84]
-28	T-1S6-20-XXX-2	T-1S6-19-XXX-2	N/A	0.230 [5.84]
-29(4)	T-1S6-19-XXX-2	N/A	N/A	0.320 [8.13]
-30 (4)	T-1S6-20-XXX-2	T-1S6-19-XXX-2	N/A	0.320 [8.13]

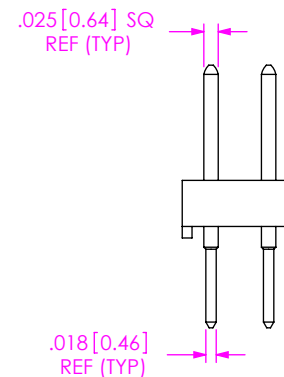



FIG 6
(-26 LEAD STYLE)
(SAME AS FIG. 1, DIFFERENT AS SHOWN)

- (1) .230[5.84] POST FOR -RA OR -RE OPTION
- (2) OMIT WITH -Q ROW SPECIFICATION
- (3) NOT AVAILABLE IN -RA OR -RE OPTION
- (4) NOT AVAILABLE IN -RE OPTION

- (5) AVAILABLE IN -LL OPTION
- (6) AVAILABLE IN -LA OPTION
- (7) ON STYLE -08 -LA, RA: "C" = .230[5.84]±.005[0.13] .008[0.20]
- (8) 1.220[30.99] POST FOR STRAIGHT PIN VERSION

* SQUARE END OF PIN (T-1RS7-01-XXX-2 SHOULD BE LOCATED AT "C" DIMENSION DURING FILL PROCESS. (SEE FIG. 6)

<p>DO NOT SCALE DRAWING</p> <p>SHEET SCALE: 3:1</p>	<p>PROPRIETARY NOTE</p> <p><small>THIS DOCUMENT CONTAINS CONFIDENTIAL AND PROPRIETARY INFORMATION AND ALL DESIGN, MANUFACTURING, REPRODUCTION, USE, PATENT RIGHTS AND SALES RIGHTS ARE EXPRESSLY RESERVED BY SAMTEC, INC. THIS DOCUMENT SHALL NOT BE DISCLOSED, IN WHOLE OR PART, TO ANY UNAUTHORIZED PERSON OR ENTITY NOR REPRODUCED, TRANSFERRED OR INCORPORATED IN ANY OTHER PROJECT IN ANY MANNER WITHOUT THE EXPRESS WRITTEN CONSENT OF SAMTEC, INC.</small></p>	 <p>520 PARK EAST BLVD, NEW ALBANY, IN 47150 PHONE: 812-944-6733 FAX: 812-948-5047 e-Mail info@SAMTEC.com code 55322</p>
	<p>DESCRIPTION: .025[0.64] SQ. POST TERMINAL STRIP ASSEMBLY</p>	
	<p>DWG. NO. TSW-XXX-XX-XXX-X-XX-XXX</p>	
	<p>BY: KOLB 08/24/1988 SHEET 6 OF 6</p>	