



Image for illustrative purpose only

Summary

[Request a quote](#)

[Catalog](#)

Number of contacts Low Voltage	8
Wire Size/AWG	28 - 20
Gender	Standard
Socket / Receptacle	Socket / Receptacle - Fixed Panel Front Mounted
Locking system	Push-pull
Jacket cable outside diameter [mm]	2.00 - 16.60 mm
Size	3B
Suggested matching part	FGG.3B.308.CLAD10
Series	B - Indoor keyed

https://www.lemo.com/int_en/solutions/originals/b-indoor-keyed/hgg-3b-308-cllpv.html

LEMO products and services are provided "as is". LEMO makes no warranties or representations with regard to LEMO product & services or use of them, express, implied or statutory, including for accuracy, completeness, or security. The user is fully responsible for his products and applications using LEMO components.

Technical details

Electrical Configuration

Contact Termination Low voltage	Solder
R (max)	3.6 mOhm
Insert configuration value	3B.308 - 8 Low Voltage
Insulator	L: PEEK (UL 94 / V-0/1.5)
Rated current	13 A
Vtest (contact-contact)	1650 V (AC), 2350 V (DC)
Vtest (contact-shell)	1150 V (AC), 1630 V (DC)
Contact Type	Solder
Max. Solid Conductor	0.5 mm ² (AWG 20)
Max. Stranded Conductor	0.5 mm ² (AWG 20)
Bucket Dia.	1 mm (0.039in)
Contact Dia.	1.3 mm (0.051in)
Number of contacts Low Voltage	8
Wire Size/AWG	28 - 20
Gender	Standard

Form & Material

Shell style / Model id	HG - Fixed receptacle, nut fixing, watertight or vacuum-tight
Socket / Receptacle	Fixed Panel Front Mounted
Housing material	Brass (chrome plated [SAE AMS 2460]) shell and collet nut, nickel plated [SAE AMS QQ N 290] brass latch sleeve and mid pieces
Locking system	Push-pull
Keying	G: 1 key (alpha=0, plug: male contacts, receptacle: female contacts)
Colour	Grey
Variant	Watertight / Vacuum-tested unmated (connector to device)
Weight	35.31 g

https://www.lemo.com/int_en/solutions/originals/b-indoor-keyed/hgg-3b-308-cllpv.html

LEMO products and services are provided "as is". LEMO makes no warranties or representations with regard to LEMO product & services or use of them, express, implied or statutory, including for accuracy, completeness, or security. The user is fully responsible for his products and applications using LEMO components.

Environment

Technical domain	Audio Video, Energy and Industrial, Medical, Semiconductor, Specialties and Other, Test and Measurement, Transportation, Aerospace and UAV
Environmental sealing (IP rating)	Hermetic unmated
Endurance	5000 mating cycles
Temperature range	-20°C / +80°C
Climatical Category	20/80/21
Humidity (max)	<=95% [at 60 deg C /140 F]
Shielding (min)	75 dB (10 MHz)
Shielding (min)	40 dB (1 GHz)
Shock Resistance	100 g [6 ms]
Vibration	15 g [10 Hz - 2000 Hz]
Pressure	30 bars
R leak (He) (max)	0.0000001 mbar*/s (if vacuum-tested)
Salt Spray Corrosion	>1000 hr

Cable fixation

Jacket cable outside diameter [mm]	2.00 - 16.60 mm
------------------------------------	-----------------

Drawings

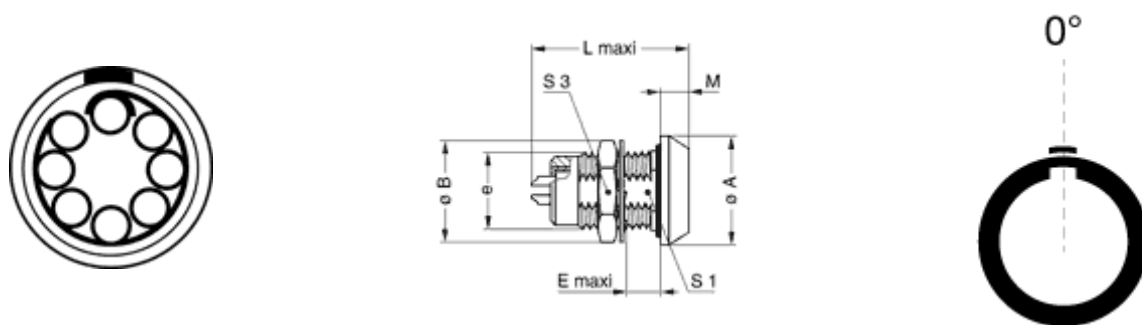

Dimensions

	S3	A	B	e	E	L	M	S1
mm.	22	25	25	M18x1.0	11.5	36.1	4	16.5
in.	0.87	0.98	0.98		0.45	1.42	0.16	0.65

https://www.lemo.com/int_en/solutions/originals/b-indoor-keyed/hgg-3b-308-cllpv.html

LEMO products and services are provided "as is". LEMO makes no warranties or representations with regard to LEMO product & services or use of them, express, implied or statutory, including for accuracy, completeness, or security. The user is fully responsible for his products and applications using LEMO components.

Recommended By Lemo

Accessories

Compatible cap [BRE.3S.200.NAS](#)







Tools

Spanner [DCA.91.282.2TN](#)

https://www.lemo.com/int_en/solutions/originals/b-indoor-keyed/hgg-3b-308-cllpv.html

LEMO products and services are provided "as is". LEMO makes no warranties or representations with regard to LEMO product & services or use of them, express, implied or statutory, including for accuracy, completeness, or security. The user is fully responsible for his products and applications using LEMO components.

Cables

Cable PartNumber	Material	Colour	Cable image
CMN.08.T20.067PGCE	PVC	Grey	
CMN.08.T20.067PGZE		grey	
CMN.08.T20.067PNZE			
CMN.08.T22.059QGC	TPR	Grey	
CMN.08.T22.059QGZE	TPR (medical)	Grey	
CMN.08.T26.042QGZE	TPR (medical)	Grey	
108220	PVC	Black	
108240	PTFE	White	
108260	PTFE	White	
16080	PVC	Grey	
180240	PVC	Black	
180260	PVC	Black	
280250	PVC	Grey	
335990	PVC	Black	
335991	PVC	Black	
380500	PVC	Grey	
380750	PVC	Grey	
42265	PVC	Yellow	
80140	PVC	Grey	
8050	PVC	Black	
8280	PVC	Black	

https://www.lemo.com/int_en/solutions/originals/b-indoor-keyed/hgg-3b-308-cllpv.html

LEMO products and services are provided "as is". LEMO makes no warranties or representations with regard to LEMO product & services or use of them, express, implied or statutory, including for accuracy, completeness, or security. The user is fully responsible for his products and applications using LEMO components.