

## High Voltage Ring Style Capacitors, Class 1 and Class 2 Ceramic



### FEATURES

- High reliability
- Stackmounting is possible

### APPLICATIONS

Ring style high voltage capacitors made from class 2 ceramic dielectric can be used as coupling and bypass capacitors, capacitors where low power ratings are required and larger capacitance changes where temperature can be tolerated.

QUICK REFERENCE DATA							
DESCRIPTION	VALUE						
Ceramic Class	2					1	2
Ceramic Dielectric	R2000H (Z5U)	R6000 (Y5U)	R2000H (Z5U)	R6000 (Y5U)	R6000 (Y5U)	R85 (U2J)	R4000 (Y5U)
Type	HR22		HR30			HR35	
Voltage (V <sub>p</sub> )	2800	2800	3500	5600	2800	3500	2000
Min. Capacitance (pF)	750	2000	1500	2500	5000	100	5000
Max. Capacitance (pF)	1000	3000	1500	2500	5000	100	5000
Mounting	Screw terminal						

### MATERIAL

Capacitor elements made from class 1 or class 2 ceramic dielectric with noble metal electrodes.

### FINISH

Noble metal electrode pure silver, inner and outer insulating rim completely protective lacquered.

### MARKING

Type designator, capacitance value and tolerance, rated peak voltage, ceramic material code, manufacturer logo.

### CAPACITANCE RANGE

100 pF to 5.0 nF

### CAPACITANCE TOLERANCE

R85, R2000H: ± 20 %

R4000, R6000: -20 % to +50 %

### CERAMIC DIELECTRIC

- R85 (U2J)
- R2000H (Z5U)
- R4000 (Y5U)
- R6000 (Y5U)

### RATED VOLTAGE

- 2.0 kV<sub>p</sub>
- 2.8 kV<sub>p</sub>
- 3.5 kV<sub>p</sub>
- 5.6 kV<sub>p</sub>

### DIELECTRIC STRENGTH TEST

300 % of rated voltage, 50 Hz, in dielectric fluid

### DISSIPATION FACTOR

- R85: max. 0.07 % (1 MHz)
- R2000H: max. 0.5 % (1 kHz)
- R4000, R6000: max. 2.5 % (1 kHz)

### INSULATION RESISTANCE

Min. 50 000 MΩ (at 25 °C)

### OPERATING TEMPERATURE RANGE

- Class 1: -55 °C to +85 °C
- Class 2: -55 °C to +100 °C

SAP PART NUMBER, ELECTRICAL AND DIMENSIONAL DATA						
PART NUMBER	CERAMIC	CAP. VALUES (pF)	RATED VOLTAGE (kVp)	D <sub>1</sub> mm (inch)	D <sub>2</sub> mm (inch)	H mm (inch)
<b>TYPE HR22</b>						
HR0022VR75138AX1	R2000H (Z5U)	750	2.8	10 (0.39)	22 (0.87)	7.5 (0.295)
HR0022VR10238AX1		1000				5.6 (0.220)
HR0022VR20291BB1	R6000 (Y5U)	2000				8.0 (0.315)
HR0022VR30291BB1		3000				5.3 (0.209)
<b>TYPE HR30</b>						
HR0030VT15238AX1	R2000H (Z5U)	1500	3.5	12 (0.47)	30 (1.81)	7.6 (0.295)
HR0030VW25291BB1	R6000 (Y5U)	2500	5.6			10.0 (0.394)
HR0030VR50291BB1		5000	2.8			5.0 (0.197)
<b>TYPE HR35</b>						
HR0035VT10138BJ1	R85 (U2J)	100	3.5	12 (0.47)	35 (1.38)	7.0 (0.276)
HR0035BB50291BA1	R4000 (Y5U)	5000	2.0			5.2 (0.205)

**Note**

- The surface temperature during operation must not exceed +100 °C

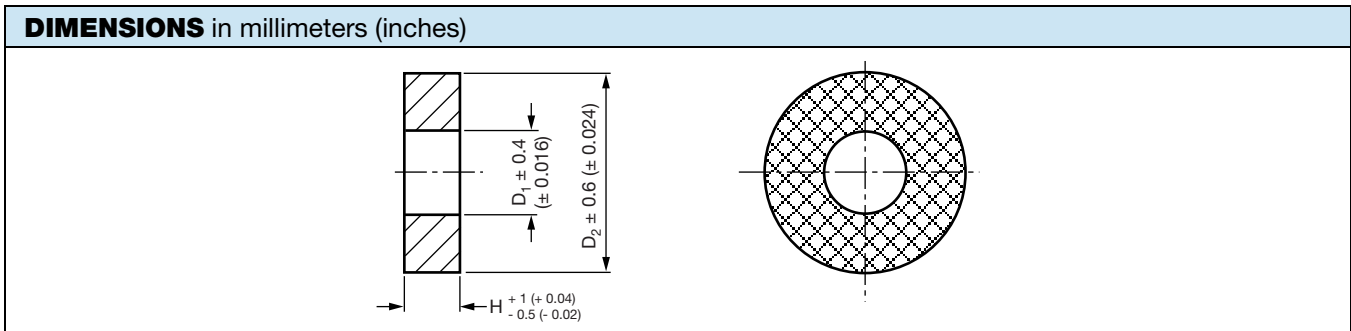

**MOUNTING GUIDELINES**

Ring style capacitors can be mounted in series.

- Avoid installation in which too much pressure or torque is applied to the capacitor elements
- Use spring washers in order to prevent the generation of physical stress to the capacitor elements and noble metal electrodes
- The capacitor elements must not be used as a mechanical support for other devices or components

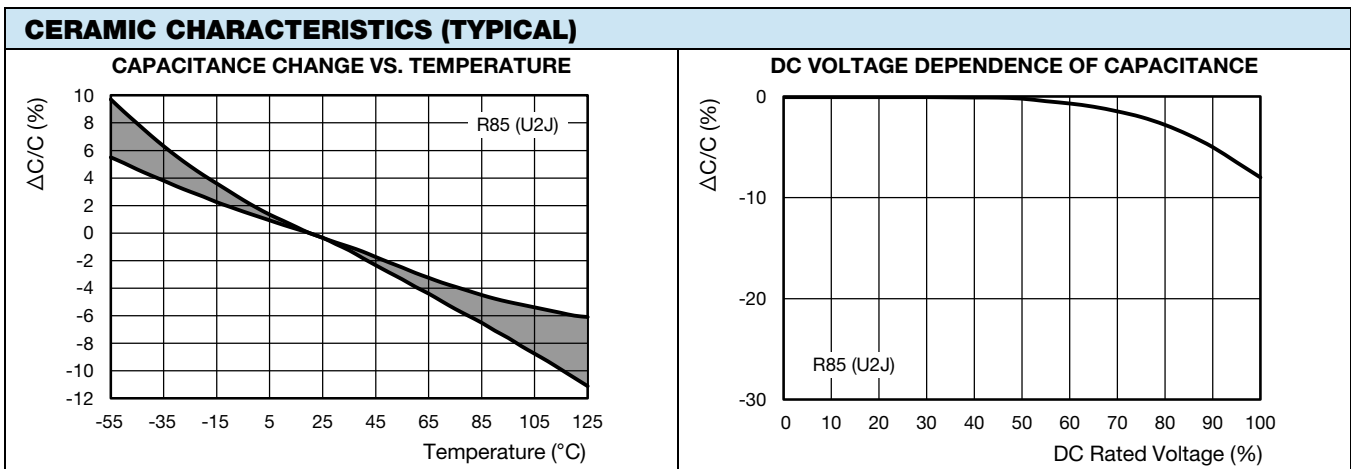



CERAMIC CHARACTERISTICS (TYPICAL)

CAPACITANCE CHANGE VS. TEMPERATURE

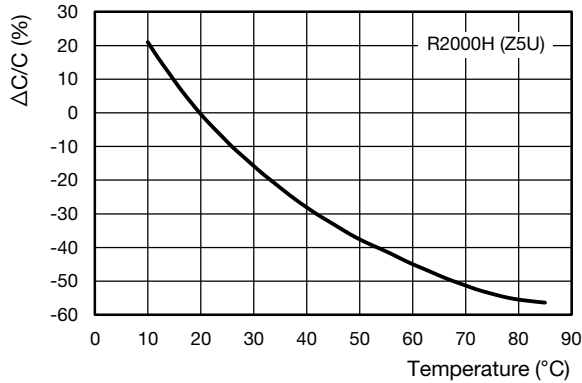

DC VOLTAGE DEPENDENCE OF CAPACITANCE

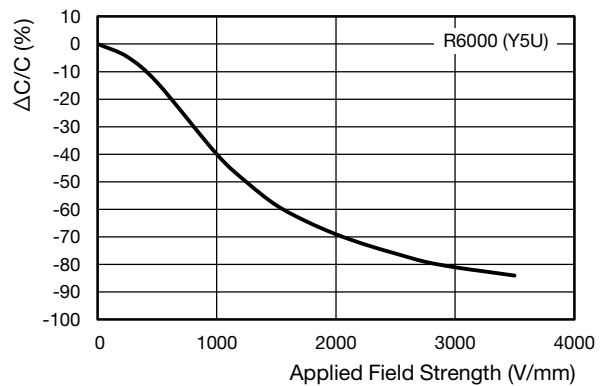
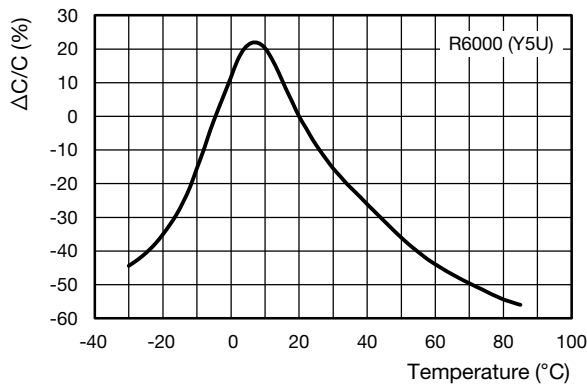
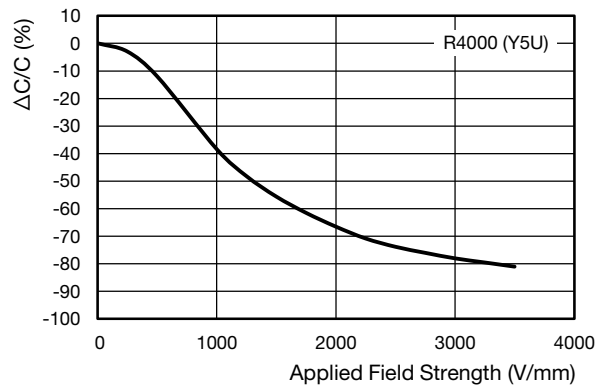
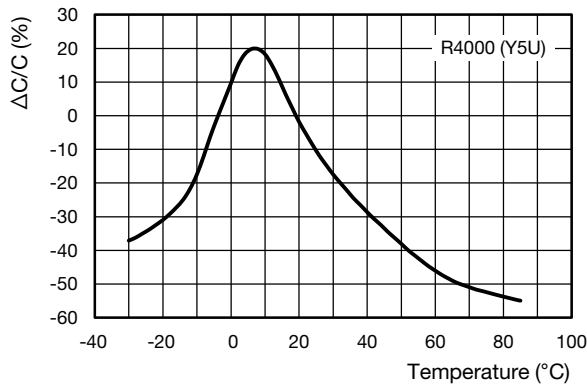
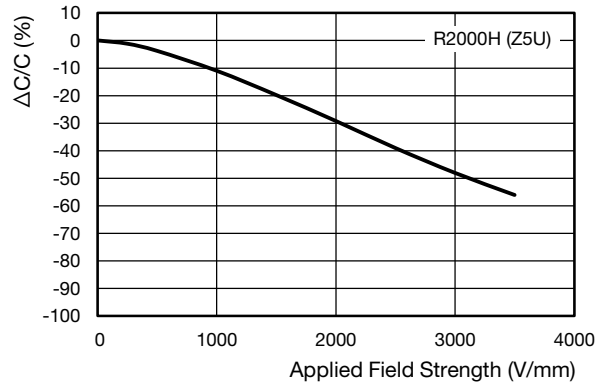

RELATED DOCUMENTS

General Information

[www.vishay.com/doc?22071](http://www.vishay.com/doc?22071)



## **Disclaimer**

ALL PRODUCT, PRODUCT SPECIFICATIONS AND DATA ARE SUBJECT TO CHANGE WITHOUT NOTICE TO IMPROVE RELIABILITY, FUNCTION OR DESIGN OR OTHERWISE.

Vishay Intertechnology, Inc., its affiliates, agents, and employees, and all persons acting on its or their behalf (collectively, "Vishay"), disclaim any and all liability for any errors, inaccuracies or incompleteness contained in any datasheet or in any other disclosure relating to any product.

Vishay makes no warranty, representation or guarantee regarding the suitability of the products for any particular purpose or the continuing production of any product. To the maximum extent permitted by applicable law, Vishay disclaims (i) any and all liability arising out of the application or use of any product, (ii) any and all liability, including without limitation special, consequential or incidental damages, and (iii) any and all implied warranties, including warranties of fitness for particular purpose, non-infringement and merchantability.

Statements regarding the suitability of products for certain types of applications are based on Vishay's knowledge of typical requirements that are often placed on Vishay products in generic applications. Such statements are not binding statements about the suitability of products for a particular application. It is the customer's responsibility to validate that a particular product with the properties described in the product specification is suitable for use in a particular application. Parameters provided in datasheets and / or specifications may vary in different applications and performance may vary over time. All operating parameters, including typical parameters, must be validated for each customer application by the customer's technical experts. Product specifications do not expand or otherwise modify Vishay's terms and conditions of purchase, including but not limited to the warranty expressed therein.

Hyperlinks included in this datasheet may direct users to third-party websites. These links are provided as a convenience and for informational purposes only. Inclusion of these hyperlinks does not constitute an endorsement or an approval by Vishay of any of the products, services or opinions of the corporation, organization or individual associated with the third-party website. Vishay disclaims any and all liability and bears no responsibility for the accuracy, legality or content of the third-party website or for that of subsequent links.

Vishay products are not designed for use in life-saving or life-sustaining applications or any application in which the failure of the Vishay product could result in personal injury or death unless specifically qualified in writing by Vishay. Customers using or selling Vishay products not expressly indicated for use in such applications do so at their own risk. Please contact authorized Vishay personnel to obtain written terms and conditions regarding products designed for such applications.

No license, express or implied, by estoppel or otherwise, to any intellectual property rights is granted by this document or by any conduct of Vishay. Product names and markings noted herein may be trademarks of their respective owners.